

TALLERES MECÁNICOS

MARCAN



Recambios y
Accesorios para
RACO
nfeción y
Diversas
Industrias

**A**

ALFOMBRA	15.10
ALIMENTADOR DE TIRA	15.12
ANCORAS BROTHER	6.05
ANCORAS JUKI	5.08
ANCORAS KANSAI	4.14
ANCORAS MAUSSER	10.03
ANCORAS PEGASUS	3.09
ANCORAS REECE	8.02
ANCORAS RIMOLDI	1.19
ANCORAS SIRUBA	2.18
ANCORAS UNION SPECIAL	9.03
ANCORAS VARIAS	12V.01
ANCORAS YAMATO	7.08
APARATO ZERO-MAX	15.13
ASPIRADORES DE CADENETA	12V.03
ATACADOR DE CADENETA RIMOLDI	1.50
ATACADORES DE CADENETA	12V.02

B

BOBINAS	13E.01
---------	--------

C

CANILLERO	15.09
CAJAS DE BOBINA	13D.01
CARRO DE EXTENDER	14CR.01
CINTAS ABRASIVAS	14CR.09
CINTAS METRICAS	15.11
COLGADORES	15.18
CONECTORES	14CR.09
CORDON MITCHELL'S	15.11
CORSETERIA	13A.01
CORTANTE MANUAL	1.49
CORTANTE NEUMATICO	1.49
CORTANTE NEUM. RIMOLDI OWERLOCK	1.49
CORTANTES PEGASUS	3.21
CUCHILLAS ADLER	12.01
CUCHILLAS BROTHER	6.06
CUCHILLAS CIRCULARES	14CR.05-07
CUCHILLAS DE CINTA CONTINUA	14CR.04
CUCHILLAS JUKI	5.06
CUCHILLAS KANSAI	4.15
CUCHILLAS MAQUINA VERTICAL	14CR.06
CUCHILLAS MAUSSER	10.04
CUCHILLAS PEGASUS	3.10
CUCHILLAS REECE	8.03
CUCHILLAS RIMOLDI	1.22
CUCHILLAS SINGER	11.04
CUCHILLAS SIRUBA	2.18
CUCHILLAS UNION SPECIAL	9.04

D

DESTORNILLADORES	15.08
DIENTES BROTHER	6.03
DIENTES JUKI	5.05
DIENTES MAQUINA DE REPUNTAR	13.01
DIENTES MAUSSER	10.05
DIENTES PEGASUS	3.06
DIENTES RIMOLDI	1.18
DIENTES SINGER	11.01
DIENTES SIRUBA	2.17
DIENTES YAMATO	7.05
DISPOSITIVOS RIMOLDI	1.53
DISPOSITIVOS UNION SPECIAL	9.06

E

ENCHUFE	15.09
ENHEBRADORES	15.17
ESPEJO	15.08

F

FILETAS	15.06
FRUNCIDOR OWERLOCK RIMOLDI	1.51
FRUNCIDOR SIRUBA	2.26

G

GARFIOS	13B.01
GUANTES	14CR.09
GUIAS DE COSTURA	15.01
GUIAS DE CAMALES	15.04

I

IMANES	15.08
--------	-------

J

JUEGOS DE COSTURA BERNINA	13.04
JUEGOS DE COSTURA BROTHER	6.01
JUEGOS DE COSTURA JUKI	5.01
JUEGOS DE COSTURA KANSAI	4.01
JUEGOS DE COSTURA PEGASUS	3.11
JUEGOS DE COSTURA RIMOLDI	1.12
JUEGOS DE COSTURA SIRUBA	2.01
JUEGOS DE COSTURA UNION SPECIAL	9.01

L

LAMPARA	15.11
LANZADERAS	13C.01
LIMAS DIAMANTADAS	14.08
LIMAS DIAMANTADAS	14CR.04
LUBRICADOR	15.10
LUPAS	15.09
LUZ FRIA	15.10



M

MAQUINA DE CORTAR TIRA	14CR.01
MAQUINA DE CORTE "RSD-100"	14CR.03
MAQUINA DE CORTE "SU LEE"	14CR.01
MAQUINA EMBOLSAR	15.17
MAQUINA SIERRA CINTA	14CR.01
MAQUINA VERTICAL	14CR.03
MAQUINAS DE AFILAR CUCHILLAS	15.15
MAQUINAS DE AFILAR TIJERAS	15.15
MAQUINAS DE CORTE "ALL-STAR"	14CR.02
MAQUINAS DE CORTE "CUT-AIR"	14CR.03
MUELAS BRUÑIDORA	15.15

P

PALANCA MOTOR	15.09
PIEDRAS DE PULIR	15.18
PINZA DE BOTONES	15.07-08-17
PINZAS DE SUJECCION	14CR.09
PINZAS ENHEBRAR	15.08
PISTOLA ASPIRADOR/SOPLADORA	15.08-17
PISTOLA NAVETS	15.16
PISTOLA PB-20	15.17
PISTOLA QUITAMANCHAS	15.17
PLACA AGUJAS ADLER	12.01
PLACA AGUJAS BROTHER	6.03
PLACA AGUJAS JUKI	5.03
PLACA AGUJAS MAUSSER	4.06
REPUNTAR	13.01
PLACA AGUJAS MAUSSER	10.01
PLACA AGUJAS PEGASUS	3.01
PLACA AGUJAS REECE	8.01
PLACA AGUJAS RIMOLDI	1.01
PLACA AGUJAS SINGER	11.01
PLACA AGUJAS UNION SPECIAL	9.02
PLACA AGUJAS VARIOS	12V.01
PLACA AGUJAS YAMATO	7.01
PRENSAS	15.09
PRENSATELAS BROTHER	6.03
PRENSATELAS JUKI	5.04
PRENSATELAS KANSAI	4.07
PRENSATELAS MAQUINA DE REPUNTAR	13.06
PRENSATELAS PEGASUS	3.04
PRENSATELAS REECE	8.01
PRENSATELAS RIMOLDI	1.08
PRENSATELAS SINGER	11.03
PRENSATELAS SIRUBA	2.16
PRENSATELAS YAMATO	7.03
PROTECTOR OJOS	15.09
PULLEN PUNTILLA RIMOLDI	1.48
PULLERS	15.14

R

RECAMBIOS BROTHER	6.07
RECAMBIOS JUKI	5.09
RECAMBIOS PEGASUS	3.18
RECAMBIOS REECE	8.01
RECAMBIOS RIMOLDI	1.25
RECAMBIOS SINGER	4.15
RECAMBIOS KANSAI	11.04
RECAMBIOS SIRUBA	2.19
RECAMBIOS UNION SPECIAL	9.02-04
RECAMBIOS YAMATO	7.11
RECOGER ETIQUETA	15.16
REGULADOR DE GOMA Y PUNTILLA	15.12
REGULADOR DE GOMA ZERO-MAX	15.13

S

SOPORTE CREMALLERA	15.08
SOPORTE PISTOLA NAVETS	15.16
SOPORTE ROLLO TIRA	15.06
SOPORTES AGUJA JUKI	5.04
SOPORTES AGUJA BROTHER	6.04
SOPORTES AGUJA PEGASUS	3.08
SOPORTES AGUJA RIMOLDI	1.11

T

TABLA COSTURA KANSAI	4.10
TENSORES	15.05
TIJERAS	15.11
TORNILLERIA	12V.06
TORNILLERIA BROTHER	12V.09
TORNILLERIA JUKI	12V.09
TORNILLERIA KANSAI	12V.08
TORNILLERIA MAUSSER	12V.09
TORNILLERIA PEGASUS	12V.08
TORNILLERIA REECE	12V.09
TORNILLERIA RIMOLDI	12V.08
TORNILLERIA SIRUBA	12V.08
TORNILLERIA UNION SPECIAL	12V.09
TORNILLERIA VARIOS	12V.09
TORNILLERIA YAMATO	12V.09

V

VALVULAS NEUMATICAS DE PEDAL	15.10
------------------------------	-------

Z

ZERO-MAX	15.14
----------	-------



ACCESORIOS

ALIMENTADOR DE TIRA	15.12
APARATO ZERO-MAX	15.13
ASPIRADORES DE CADENETA	12V.03
COLGADORES	15.18
CORSETERIA	13A.01
CORTANTE MANUAL	1.49
CORTANTE NEUMATICO	1.49
CORTANTE NEUMATICO RIMOLDI OWERLOCK	1.49
CORTANTES PEGASUS	3.21
DISPOSITIVOS RIMOLDI	1.53
DISPOSITIVOS UNION SPECIAL	9.06
FILETAS	15.06
FRUNCIDOR OWERLOCK RIMOLDI	1.51
FRUNCIDOR SIRUBA	2.26
PULLEN PUNTILLA RIMOLDI	1.48
REGULADOR DE GOMA Y PUNTILLA	15.12
REGULADOR DE GOMA ZERO-MAX	15.13
SOPORTE ROLLO TIRA	15.06
VALVULAS NEUMATICAS DE PEDAL	15.10

CORTE

CINTAS ABRASIVAS	14CR.09
CUCHILLAS CIRCULARES	14CR.05-07
CUCHILLAS DE CINTA CONTINUA	14CR.04
CUCHILLAS MAQUINA VERTICAL	14CR.06
GUANTES	14CR.09
LIMAS DIAMANTADAS	14CR.04
MUELAS BRUÑIDORA	15.15
PIEDRAS DE PULIR	15.18
PINZAS DE SUJECCION TEJIDOS	14CR.09

COSTURA

ANCORAS BROTHER	6.05
ANCORAS JUKI	5.08
ANCORAS KANSAI	4.14
ANCORAS MAUSSER	10.03
ANCORAS PEGASUS	3.09
ANCORAS REECE	8.02
ANCORAS RIMOLDI	1.19
ANCORAS SIRUBA	2.18
ANCORAS UNION SPECIAL	9.03
ANCORAS VARIAS	12V.01
ANCORAS YAMATO	7.08
ATACADOR DE CADENETA RIMOLDI	1.50
ATACADORES DE CADENETA	12V.02
CUCHILLAS ADLER	12.01
CUCHILLAS BROTHER	6.06
CUCHILLAS JUKI	5.06
CUCHILLAS KANSAI	4.15

COSTURA

CUCHILLAS MAUSSER	10.04
CUCHILLAS PEGASUS	3.10
CUCHILLAS REECE	8.03
CUCHILLAS RIMOLDI	1.22
CUCHILLAS SINGER	11.04
CUCHILLAS SIRUBA	2.18
CUCHILLAS UNION SPECIAL	9.04
CUCHILLAS YAMATO	7.09
DIENTES BROTHER	6.03
DIENTES JUKI	5.05
DIENTES MAQUINA DE REPUNTAR	13.01
DIENTES MAUSSER	10.05
DIENTES PEGASUS	3.06
DIENTES RIMOLDI	1.18
DIENTES SINGER	11.01
DIENTES SIRUBA	2.17
DIENTES YAMATO	7.05
GUIAS DE COSTURA	15.01
JUEGOS DE COSTURA BERNINA	13.04
JUEGOS DE COSTURA BROTHER	6.01
JUEGOS DE COSTURA JUKI	5.01
JUEGOS DE COSTURA KANSAI	4.01
JUEGOS DE COSTURA PEGASUS	
JUEGOS DE COSTURA RIMOLDI	1.12
JUEGOS DE COSTURA SIRUBA	2.01
JUEGOS DE COSTURA UNION SPECIAL	9.01
PLACA AGUJAS ADLER	12.01
PLACA AGUJAS BROTHER	6.03
PLACA AGUJAS JUKI	5.03
PLACA AGUJAS KANSAI	4.06
PLACA AGUJAS MAQUINA DE REPUNTAR	13.01
PLACA AGUJAS MAUSSER	10.01
PLACA AGUJAS PEGASUS	3.01
PLACA AGUJAS REECE	8.01
PLACA AGUJAS RIMOLDI	1.01
PLACA AGUJAS SINGER	11.01
PLACA AGUJAS UNION SPECIAL	9.02
PLACA AGUJAS VARIOS	12V.01
PLACA AGUJAS YAMATO	7.01
PRENSATELAS BROTHER	6.03
PRENSATELAS JUKI	5.04
PRENSATELAS KANSAI	4.07
PRENSATELAS MAQUINA DE REPUNTAR	13.06
PRENSATELAS PEGASUS	3.04
PRENSATELAS REECE	8.01
PRENSATELAS RIMOLDI	1.08
PRENSATELAS SINGER	11.03
PRENSATELAS SIRUBA	2.16
PRENSATELAS YAMATO	7.03
SOPORTES AGUJA JUKI	5.04
SOPORTES AGUJA BROTHER	6.04
SOPORTES AGUJA PEGASUS	3.08
SOPORTES AGUJA RIMOLDI	
TABLA COSTURA KANSAI	4.10



MAQUINARIA

CARRO DE EXTENDER	14CR.01
MAQUINA SIERRA CINTA	14CR.01
MAQUINA VERTICAL	14CR.03
MAQUINAS DE AFILAR CUCHILLAS	15.15
MAQUINAS DE AFILAR TIJERAS	15.15
MAQUINA SU LEE	14CR.01
MAQUINAS DE CORTE "ALL-STAR"	14CR.02
MAQUINAS DE CORTE "CUT-AIR"	14CR.03
MAQUINA DE CORTAR TIRA	14CR.01
MAQUINA CORTE RSD-100	14CR.01
MAQUINA EMBOLSAR	15.17

TORNILLERIA

TORNILLERIA	12V.06
TORNILLERIA BROTHER	12V.09
TORNILLERIA JUKI	12V.09
TORNILLERIA KANSAI	12V.08
TORNILLERIA MAUSSER	12V.09
TORNILLERIA PEGASUS	12V.08
TORNILLERIA REECE	12V.09
TORNILLERIA RIMOLDI	12V.08
TORNILLERIA SIRUBA	12V.08
TORNILLERIA UNION SPECIAL	12V.09
TORNILLERIA VARIOS	12V.09
TORNILLERIA YAMATO	12V.09

OTROS

ALFOMBRA	15.10
CINTAS METRICAS	15.11
CORDON MITCHELL'S	15.11
ENHEBRADORES	15.17
GUIAS DE CAMALES	15.04
LAMPARA	15.11
LUBRICADOR	15.10
LUZ FRIA	15.10
PISTOLA NAVETS	15.16
PISTOLA PB-20	15.17
PISTOLA QUITAMANCHAS	15.17
PULLERS	15.14
RECOGER ETIQUETA	15.16
SOPORTE PISTOLA NAVETS	15.16
TIJERAS	15.11
ZERO-MAX	15.14

VARIOS

BOBINAS	13E.01
CAJAS DE BOBINA	13D.01
CANILLERO	15.09
CONECTORES	14CR.09
DESTORNILLADORES	15.08
ENCHUFE	15.09
ESPEJO	15.08
GARFIOS	13B.01
IMANES	15.08
LANZADERAS	13C.01
LUPAS	15.09
PALANCA MOTOR	15.09
PINZA DE BOTONES	15.07-08-17
PINZAS ENHEBRAR	15.08
PISTOLA ASPIRADOR/SOPLADORA	14.27
PRENSAS	15.09
PROTECTOR OJOS	15.09
RECAMBIOS BROTHER	6.07
RECAMBIOS JUKI	5.09
RECAMBIOS PEGASUS	3.18
RECAMBIOS REECE	8.01
RECAMBIOS RIMOLDI	1.25
RECAMBIOS KANSAI	4.15
RECAMBIOS SINGER	11.04
RECAMBIOS SIRUBA	2.19
RECAMBIOS UNION SPECIAL	9.02-04
RECAMBIOS YAMATO	7.11
SOPORTE CREMALLERA	15.08
TENSORES	15.05

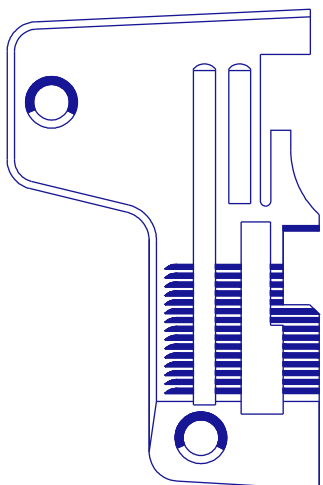

203761-0-10
PA110114

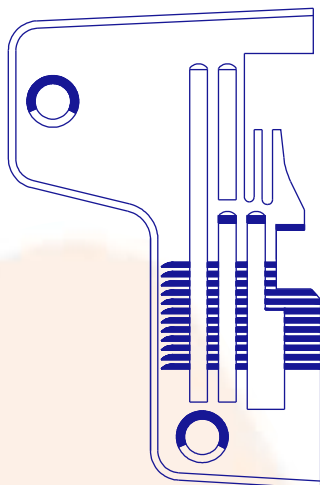

203551-0-10
PA11021

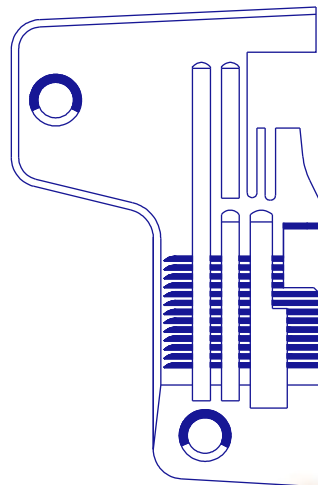

204026-0-11
PA11022

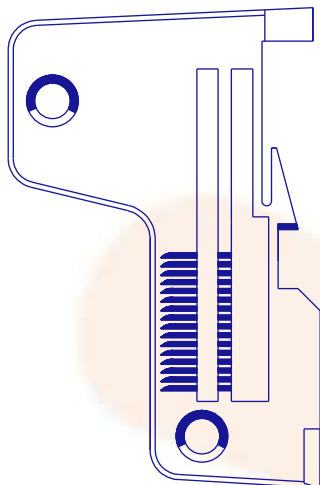

920768-0-10
PA11017

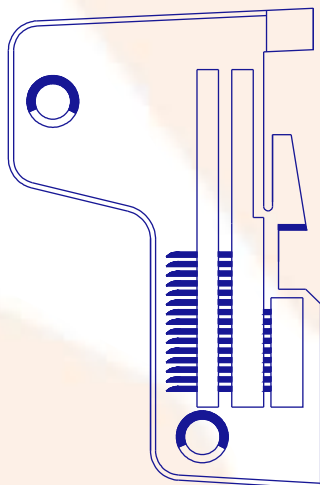

203149-0-10
PA11012

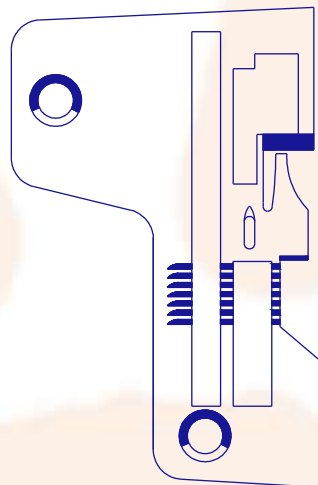

290-114
PA11023

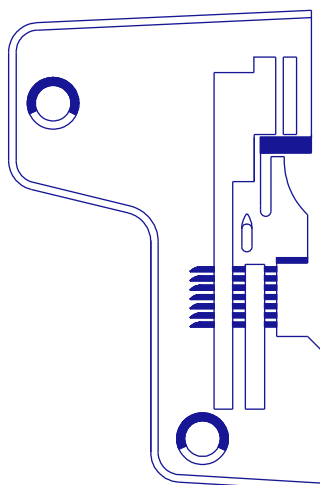

204688-0-11
PA11024

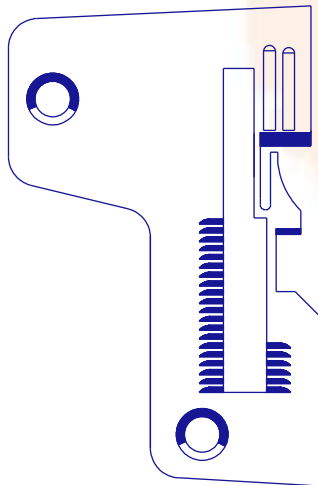

202707-0-10
PA11018

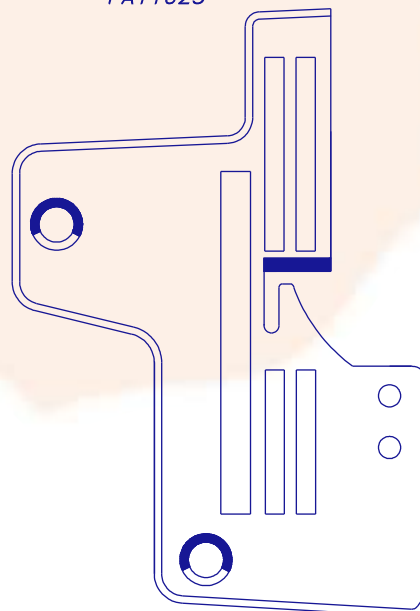

204609-0-10
PA11051

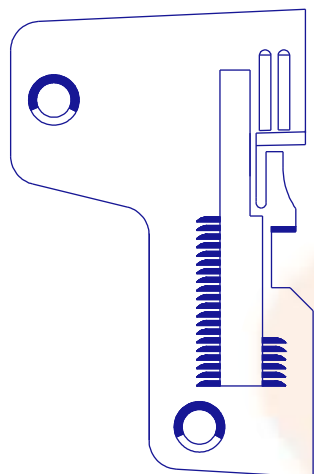

202635-0-10
PA11016

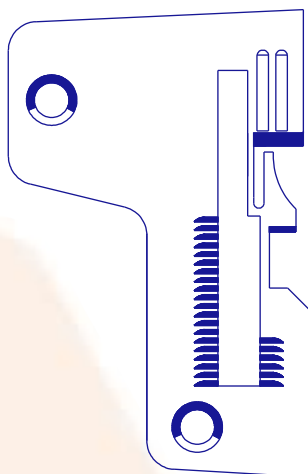

202634-0-10
PA11015

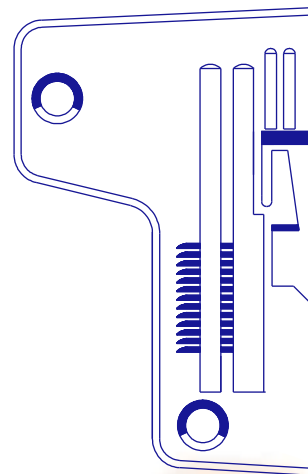

203219-0-11
PA11011

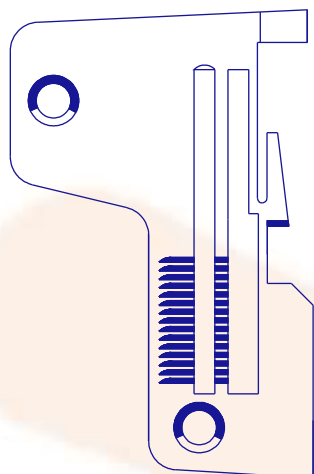

203214-0-10
PA11014

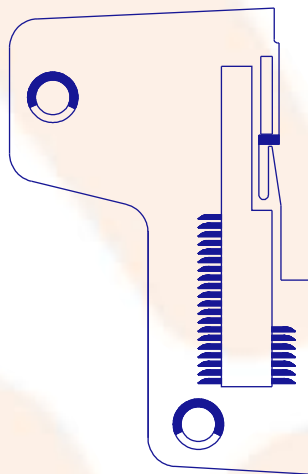

923911-0-00
PA110110

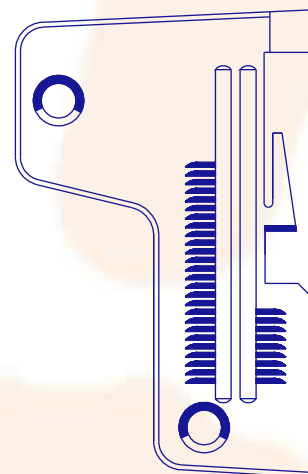

202783-0-11
PA110111

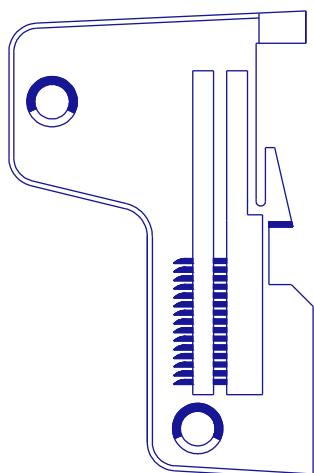

202504-0-10
PA110112

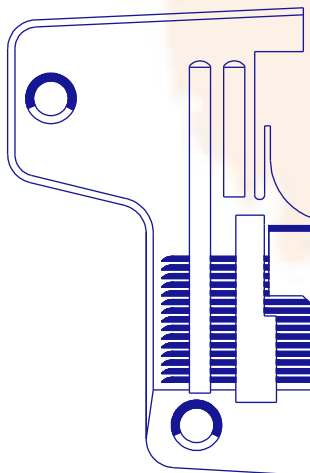

203785-0-10
PA110113

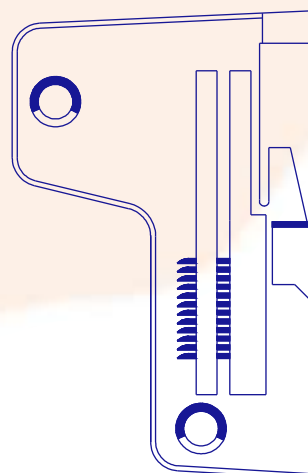

211354-0-00
PA110118

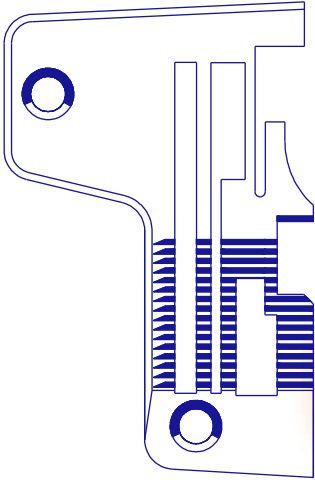

203786
PA110116

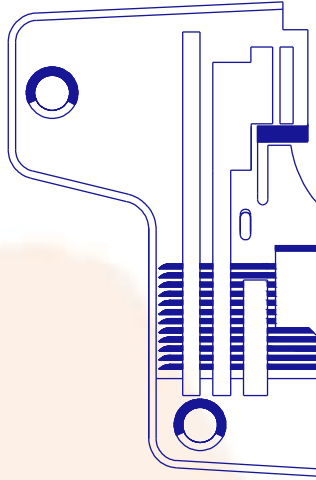

204867-0-11
PA110127

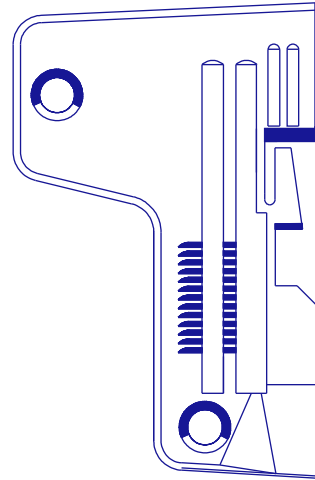

920640-0-00
PA110117

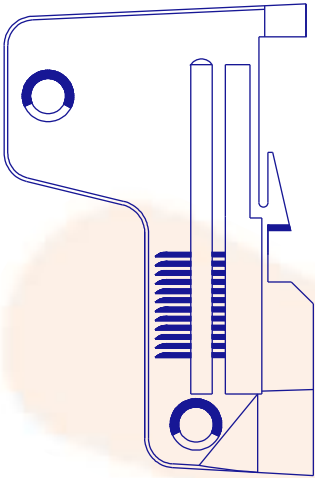

920649-0-00
PA11433

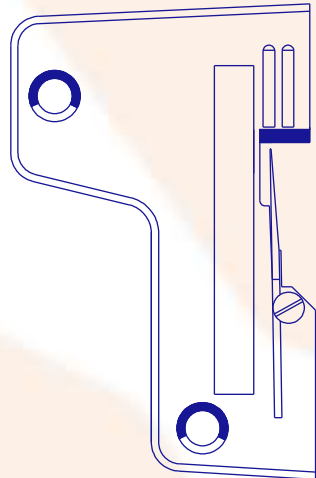

203354-4-12
PA11053

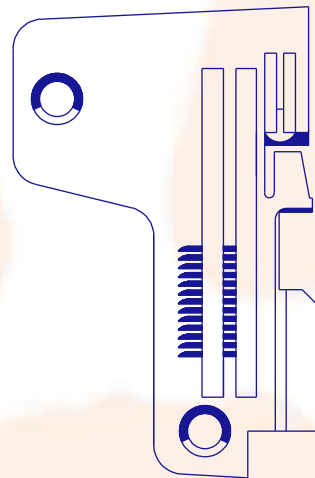

946042-0-11
PA110119

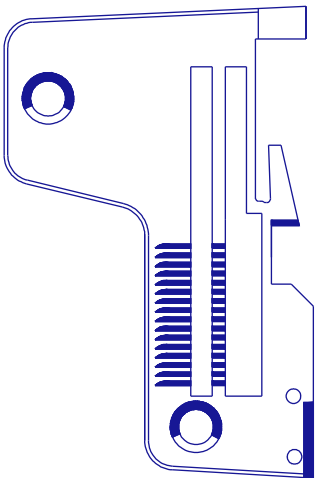

920796-0-10
PA110121

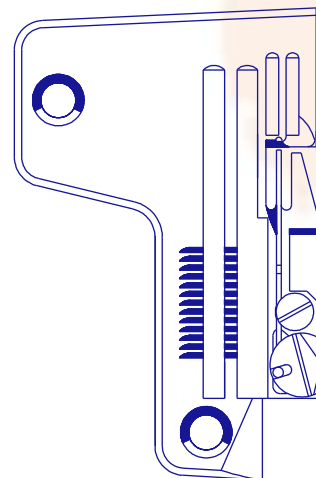

920955-4-01
PA110120

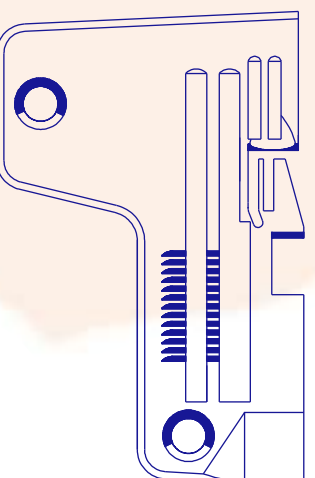

921162-0-00
PA11029

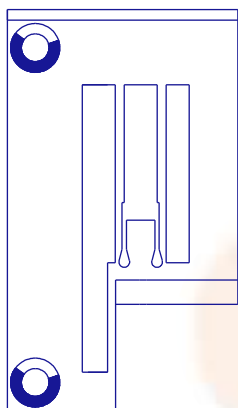

301849-0-10
PA11313

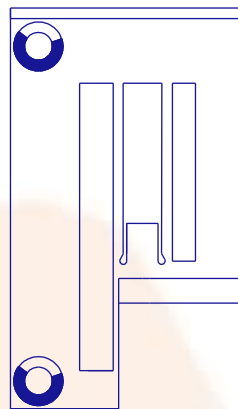

301765-0-10
PA11321

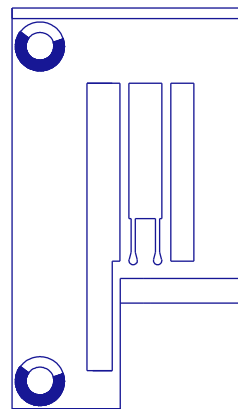

301760 → 3,5 mm
PA11322

301761-0-10 → 2,5 mm
PA11325

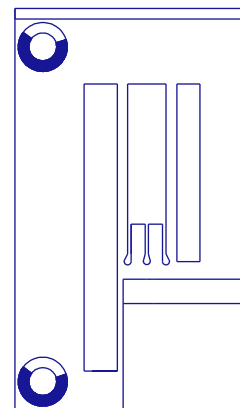

301764-0-10
PA11331

CON Ø SIN ESCALON.

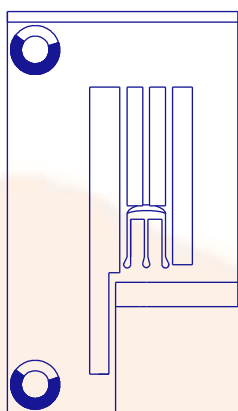

313503-0-00
PA11312

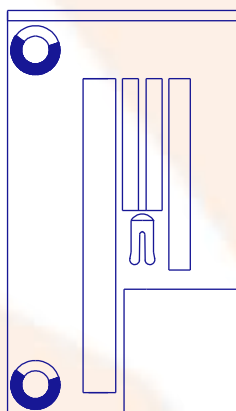

302754
PA11221

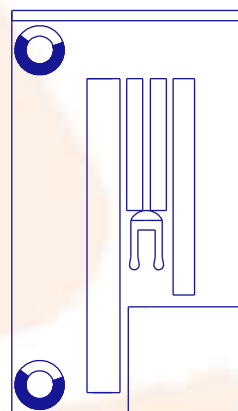

302810 → 4,5 mm
PA11223

302811-0-10 → 3,5 mm
PA11222

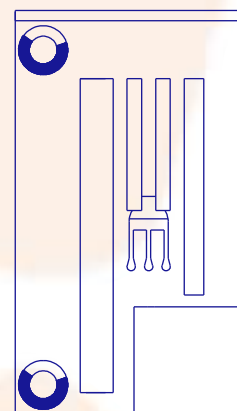

302735-0-10
PA11231

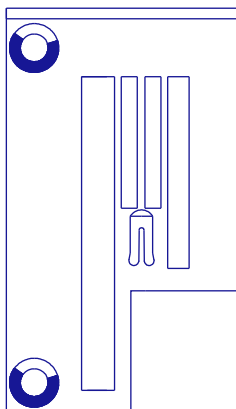

304960-0-10
PA11224

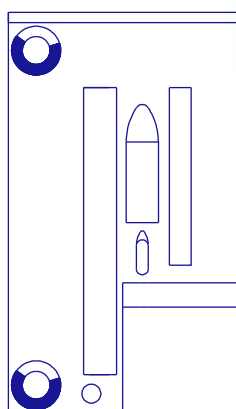

303188-0-10
PA11311

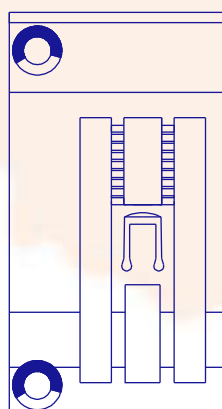

304052-0-10
PA11521

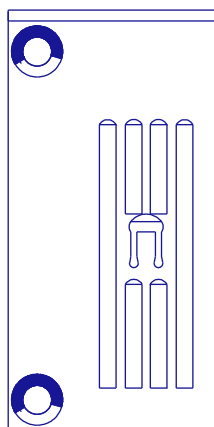

PA11425

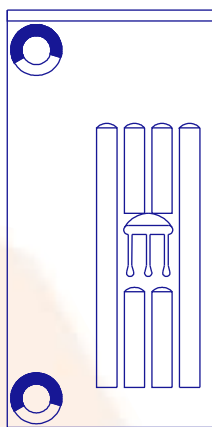

302416-0-10
PA11431

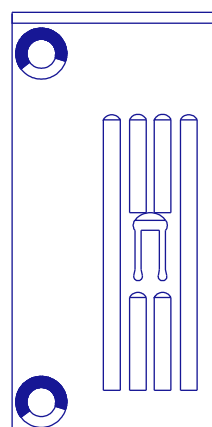

304087-0-10
PA11421

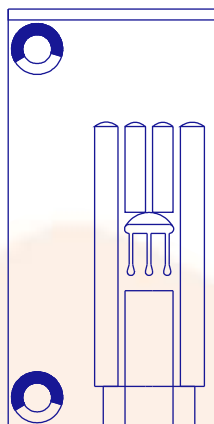

302408
PA11432

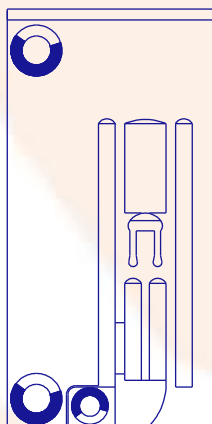

302499-4-10
PA11323

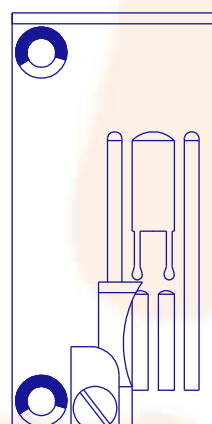

302512-4-11
PA11422

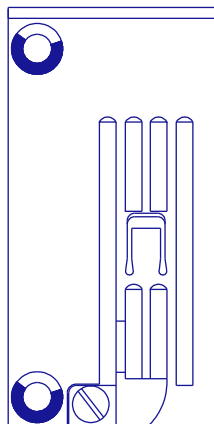

302706-4-11
PA11019

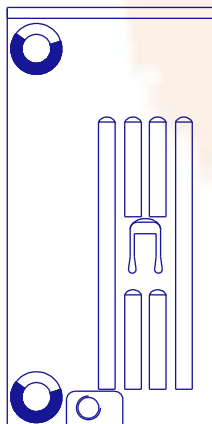

302498-0-11
PA11140

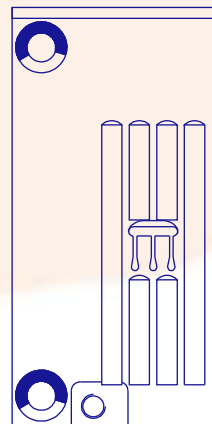

302426-0-10
PA11413

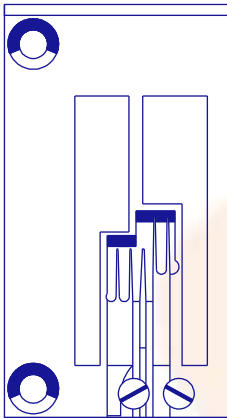

313043-4-00
PA11121

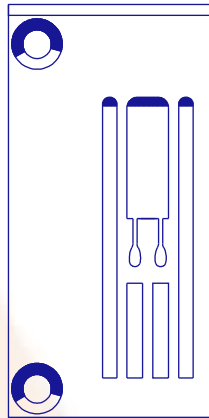

302501-0-10
PA11027

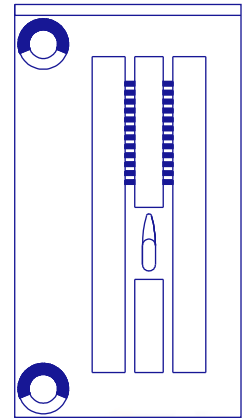

303934-0-10
PA11412

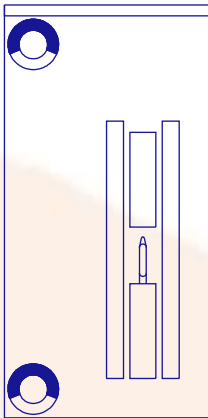

303718-0-10
PA11411

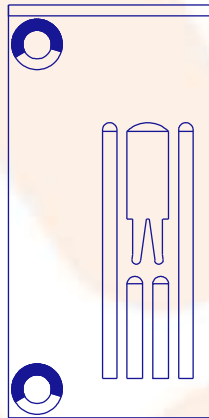

302888-0-10
PA11423

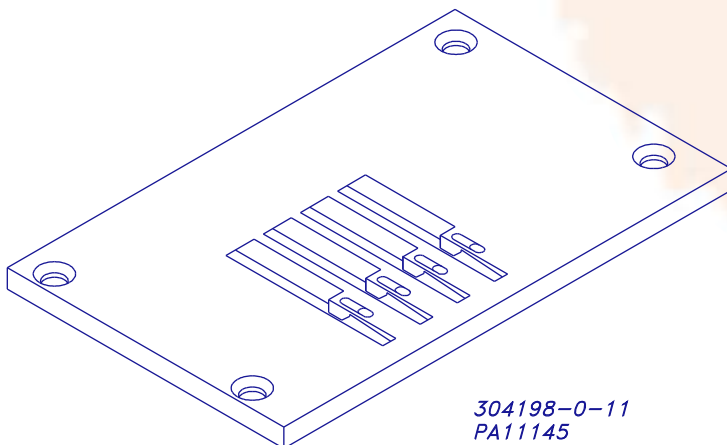

304198-0-11
PA11145

304199-0-11
PA11144

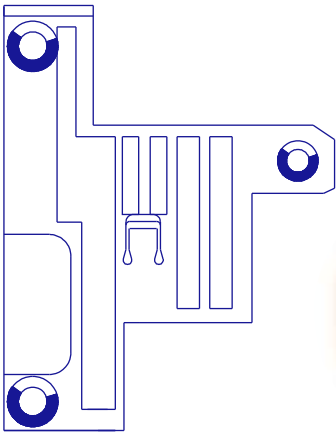

929748-0-00 → 3,5 mm
PA11424
929707-0-00 → 4,5 mm
PA11434

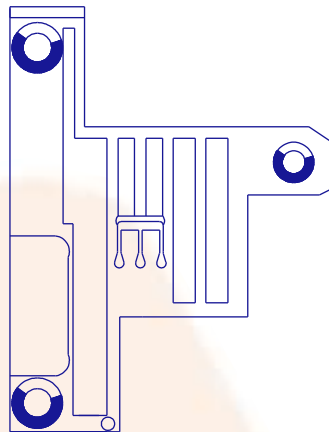

929786-0-00
PA11232

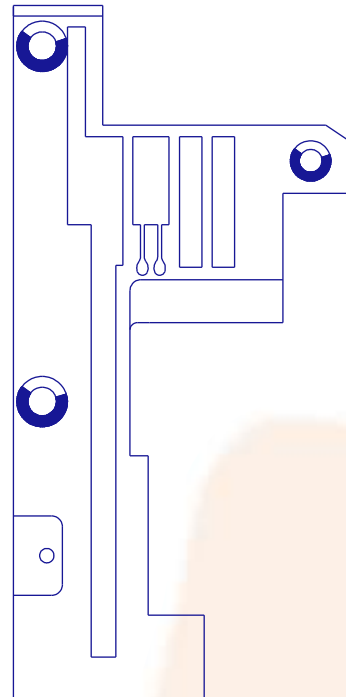

PA11427 → 3,5 mm
PA11428 → 2,5 mm

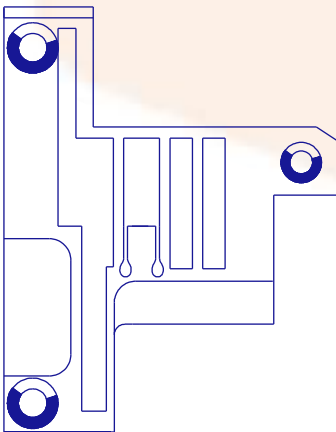

933103-0-00
PA11324

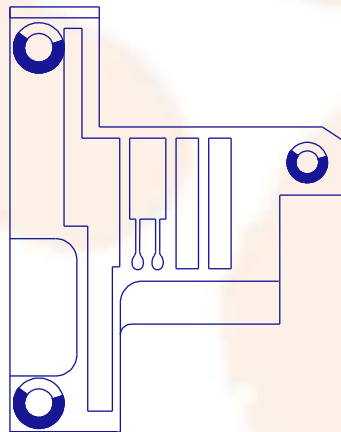

PA11426 → 2,5 mm

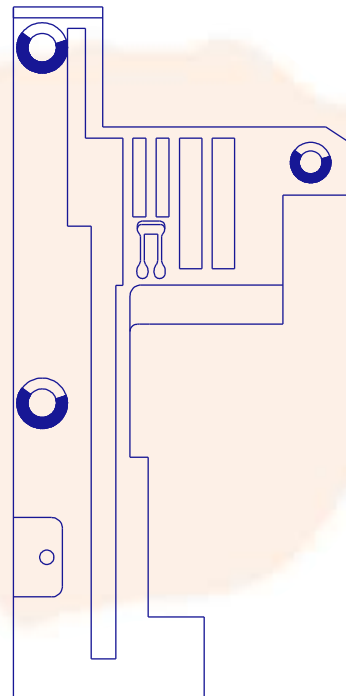

PA11429 → 2,5 mm

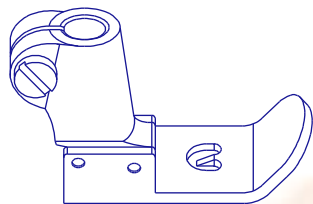

302600 → 4,5 mm
PS11422
301004-3-11 → 3,5 mm
PS11421

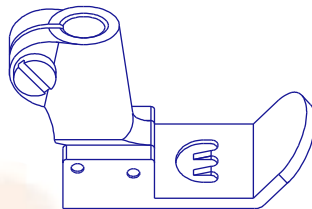

302410-3-11
PS11431

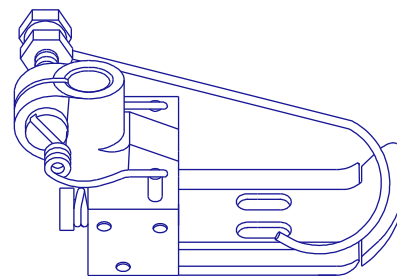

306611 → 4,5 mm
PS11423

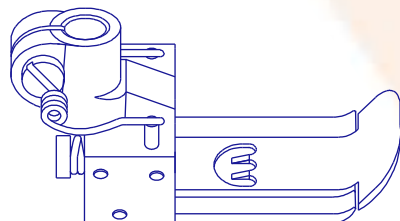

300581-3-13
PS11432

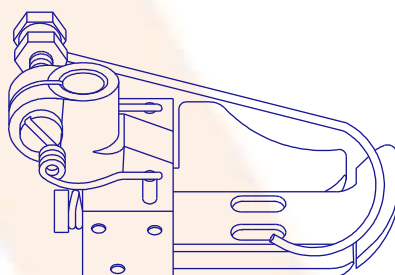

306632-3-00 → 3,5 mm
PS11424

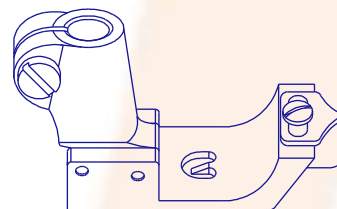

PS11425 3,5 mm
PS11426 4,5 mm

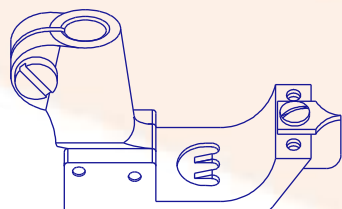

PS11437

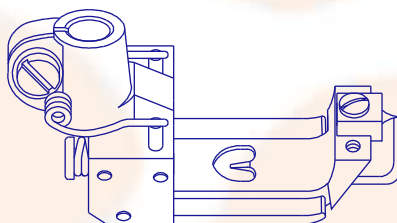

314203-7 → 3,5 mm
PS11225

314203-2 → 4,5 mm
PS11226

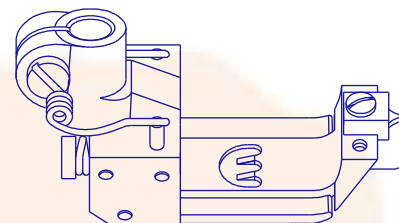

314203-1
PS11436

314203-3 → 4,5 mm
PS11220

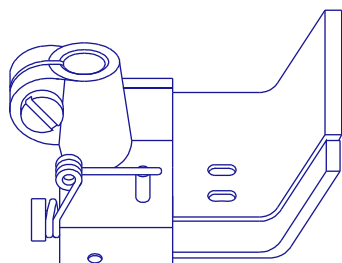

306669-3-00
PS11521

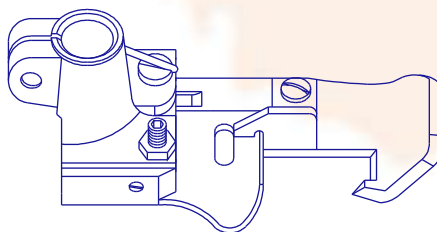

304961-3-10
PS11991

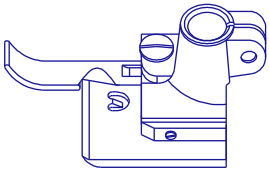

300145
PS11322
300110-3-11
PS11321

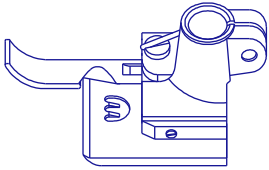

300111-3-13
PS11331

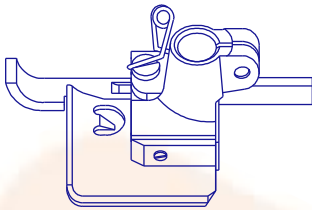

929740-3-01
PS11224

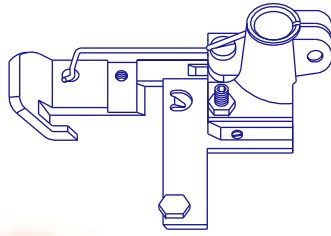

302755-3-11 → 3,5 mm
PS11221
304488 → 4,5 mm
PS11222

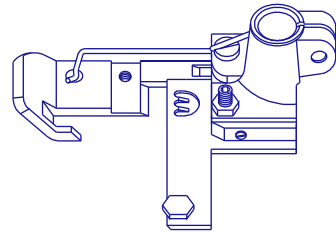

304378-3-11
PS11232



304411-0-11
VA1120121

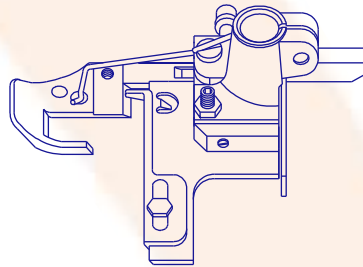

929746-3-01 → 3,5 mm
PS11223
929704-3-00 → 4,5 mm
PS11033

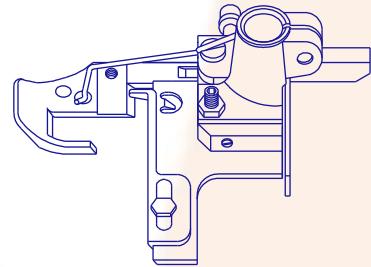

929787-0-00
PS11034

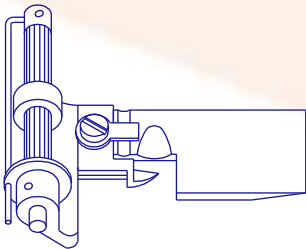

207116/2
PS11036 - Prensateles 1 ag. goma regulable rodillo 10 mm.
207116/1
PS11035 - Prensateles 1 ag. goma regulable rodillo 30 mm.
207116
PS11014 - Prensateles 1 ag. goma regulable rodillo 45 mm.

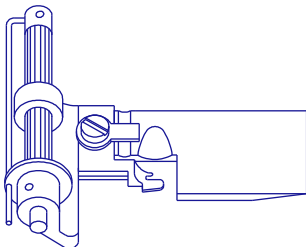

PS11010/2 - Prensateles 2 ag. goma regulable rodillo 10 mm.
PS11010 - Prensateles 2 ag. goma regulable rodillo 30 mm.
PS11010/1 - Prensateles 2 ag. goma regulable rodillo 45 mm.

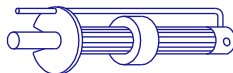

VA40410124 → 10 mm
VA40410121 → 30 mm
VA40410122 → 45 mm

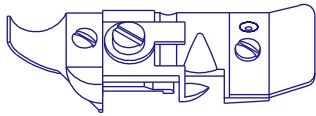

202171-3-10
PS11011

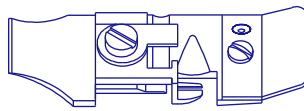

204009-3-10
PS11021

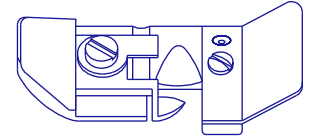

203157-3-10
PS11015

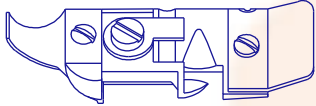

202786-3-11
PS11017

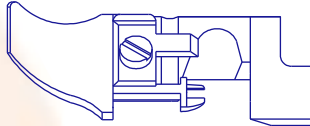

204037-3-11
PS11027

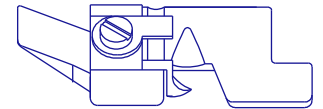

202642-3-11
PS11013

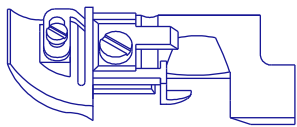

203016
PS11012

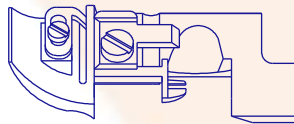

204010
PS11032

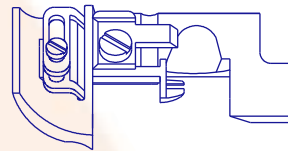

204028-3-11
PS11020

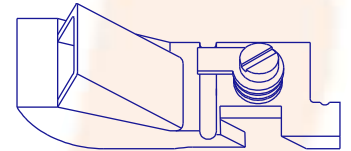

PS11018

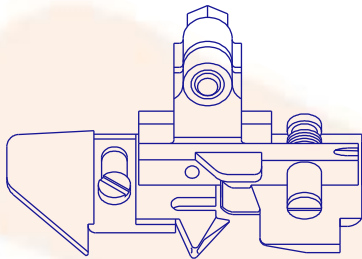

205070-3-12
PS11029

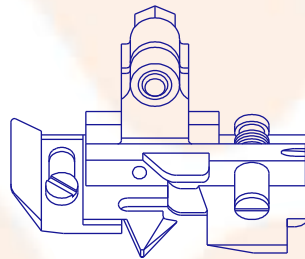

204875-3-12
PS11022



204876
PS11025

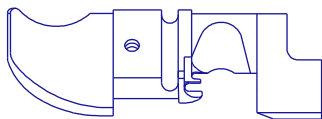

204037
PS11026
TEFLON

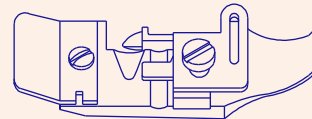

202178-0-00
PS11028

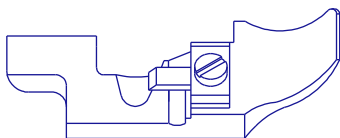

BM6001
PS11030

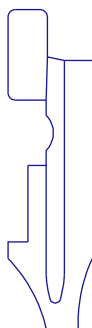

BM6002
PS11031

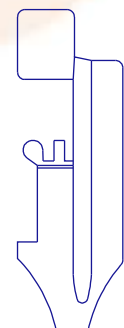
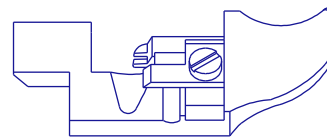

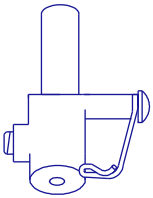

207510-4-00
SA11011

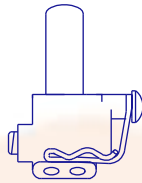

207512-4-00
SA11021

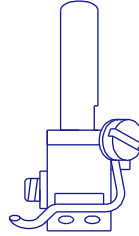

309803-4-00 → 3,5 mm
SA11421
309806-4-00 → 4,5 mm
SA11422
309755-0-00 → 2,5 mm
SA11444

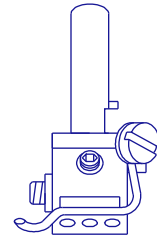

309800-4-01
SA11431
309751-2-02
SA11446

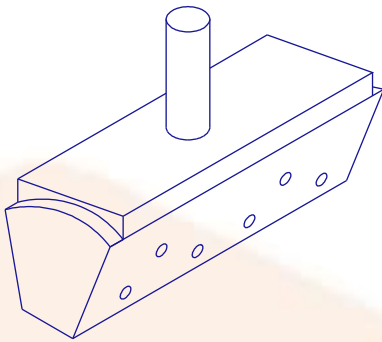

304150-4-10 SA11441
304152-4-10 SA11442
306081-4-10 SA11443

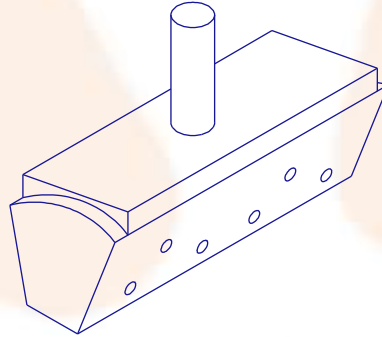

304148
SA11141

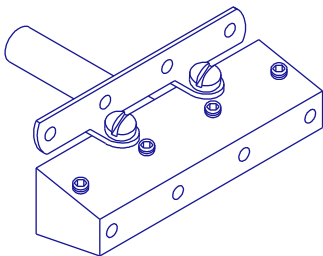

304146-4-10
SA11447



JUEGO DE OWERLOCK 1 AGUJA 3 HILOS

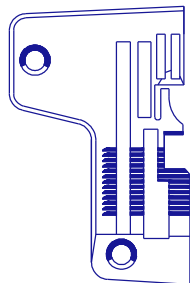

203035-0-10
PA110115

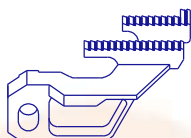

203028-0-11
DT110110

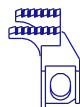

203031-0-10
DT110111



203004-0-10
DT110112



203017-3-11
PS11016

JUEGO DE OWERLOCK PLISADOR

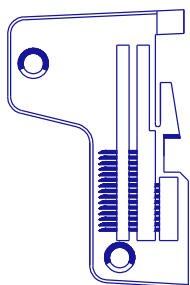

203149-0-10
PA11012

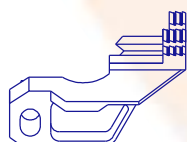

203140-0-10
DT11017

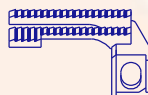

203141-0-11
DT11018



202061-0-10
DT11019

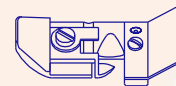

203157-3-10
PS11015

JUEGO DE OWERLOCK 1 AGUJA 3 HILOS

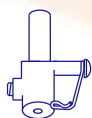

207510-4-00
SA11011

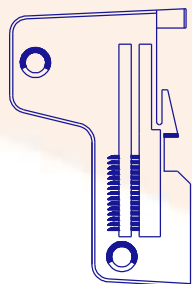

202504-0-10
PA110112

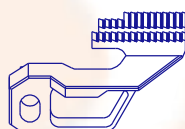

202053-0-10
DT11012



202057-0-10
DT11013



202061-0-10
DT11019



202171-3-10
PS11011

JUEGO OWERLOCK PLISADOR

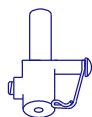

207510-4-00
SA11011

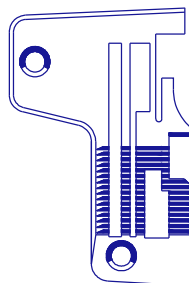

203786
PA110116

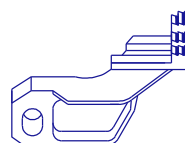

203746
DT11015

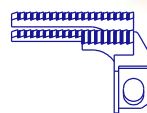

203747
DT11016



203003
DT110114



203767-3-11
PS11019



JUEGO DE OWERLOCK 1 AGUJA 3 HILOS

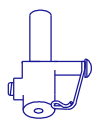

207510-4-00
SA11011

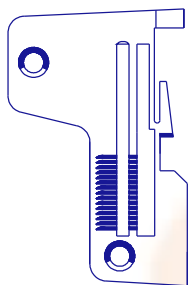

203214-0-10
PA11014

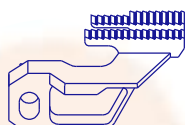

203199-0-10
DT110113

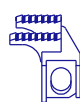

202057-0-10
DT11013



202061-0-10
DT11019



202171-3-10
PS11011

OWERLOCK 1 AGUJA 3 HILOS

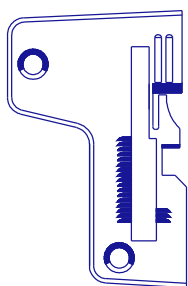

202635-0-10
PA11016

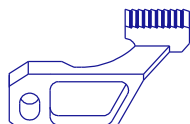

202605-0-10
DT11014

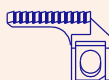

202608-0-10
DT11011



202609-0-10
DT11026



202642-3-11
PS11013

OWERLOCK 2 AGUJAS 4 HILOS

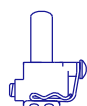

207512-4-00
SA11021

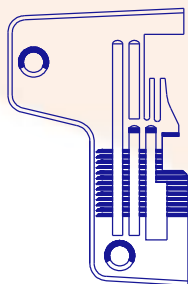

203551-0-10
PA11021

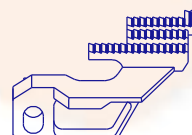

203533-0-10
DT11021



203540-0-10
DT11022



203612-0-10
DT11023



204009-3-10
PS11021

JUEGO OWERLOCK 5 HILOS

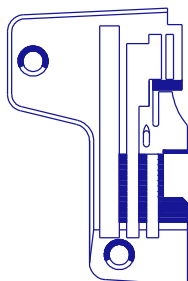

208043-0-02
PA11026

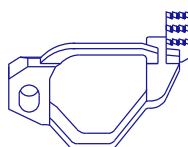

208042-0-10
DT11027

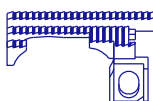

208053-0-10
DT11028



202609-0-10
DT11026

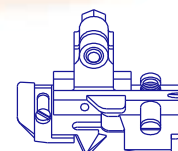

204875-3-12
PS11022



OWERLOCK 2 AGUJAS 5 HILOS

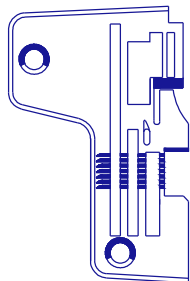

204864-0-15
PA11025

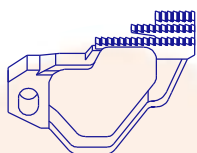

204846-0-13
DT11024



204850-0-10
DT11025



202609-0-10
DT11026

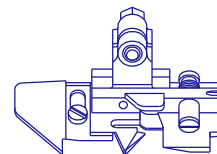

204950-3-12
PS11023

JUEGO OWERLOCK SACOS

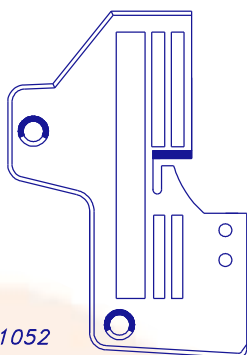

PA11052

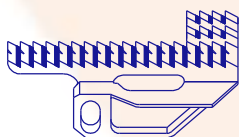

DT11051

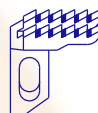

DT11052

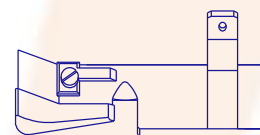

PS11052

JUEGO MAQUINA 4 AGUJAS

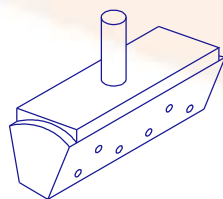

304148
SA11141

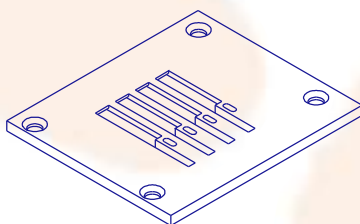

304199-0-11
PA11144

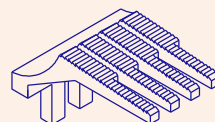

304161-0-10
DT11145

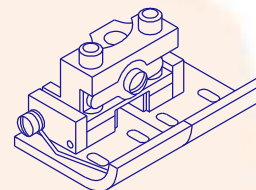

306673
PS11141

JUEGO MAQUINA 4 AGUJAS

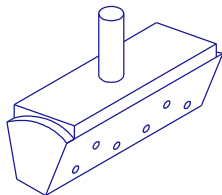

304150-4-10 SA11441
304152-4-10 SA11442
306081-4-10 SA11443

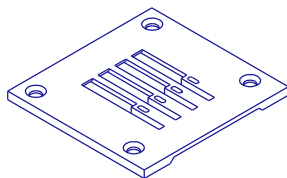

304200-0-11 PA11141
304201-0-11 PA11142
306087-0-11 PA11143

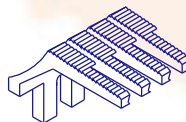

304162-0-10 DT11141
304163-0-10 DT11142
306082-0-10 DT11143

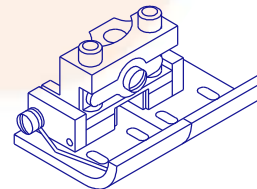

306674-3-00 PS11541
306675-3-00 PS11542
306088-3-10 PS11543



TIRA 2 AGUJAS

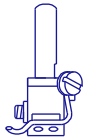

309803-4-00
SA11421

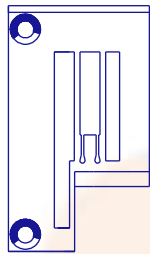

301760
PA11322

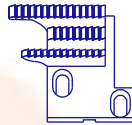

300102-0-10
DT11321

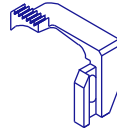

300104-0-11
DT11322

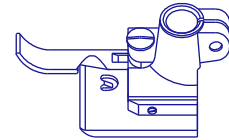

300110-3-11
PS11321

JUEGO DE TIRAS 3 AGUJAS

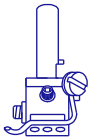

309800-4-01
SA11431

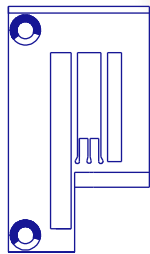

301764-0-10
PA11331

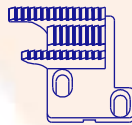

300133-0-10
DT11332

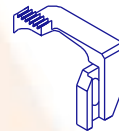

300135-0-10
DT11331

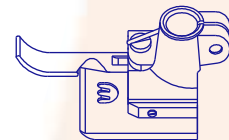

300111-3-13
PS11331

PUNTILLA 2 AGUJAS

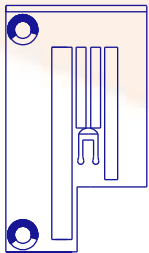

302811-0-10
PA11222

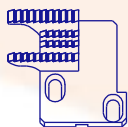

302796-0-10
DT11202

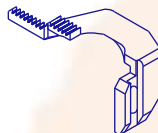

302798-0-10
DT11201

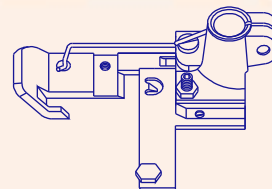

302755-3-11
PS11221

PUNTILLA 3 AGUJAS

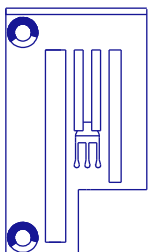

302735-0-10
PA11231

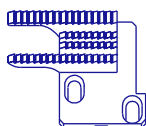

302795-0-10
DT11232

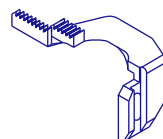

302797-0-10
DT11231

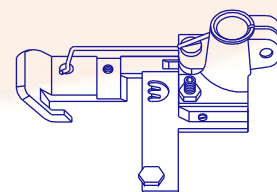

304378-3-11
PS11232



JUEGO DE BORAS 2 AGUJAS

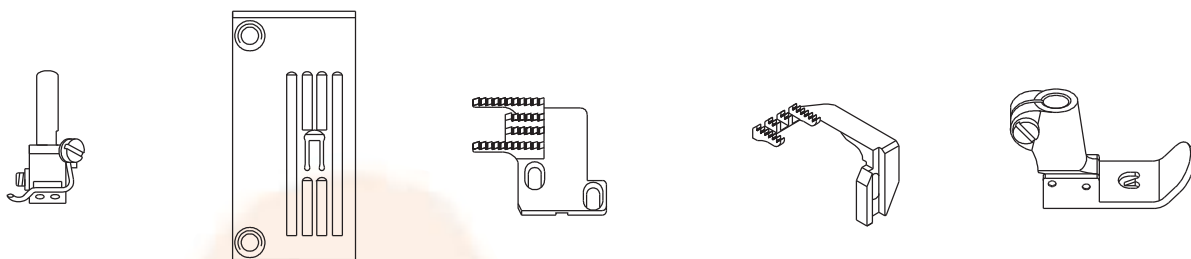

309803-4-00
SA11421

304087-0-10
PA11421

302488-0-11
DT11421

302491-0-11
DT11422

301004-3-11
PS11421

JUEGO DE BORAS 3 AGUJAS

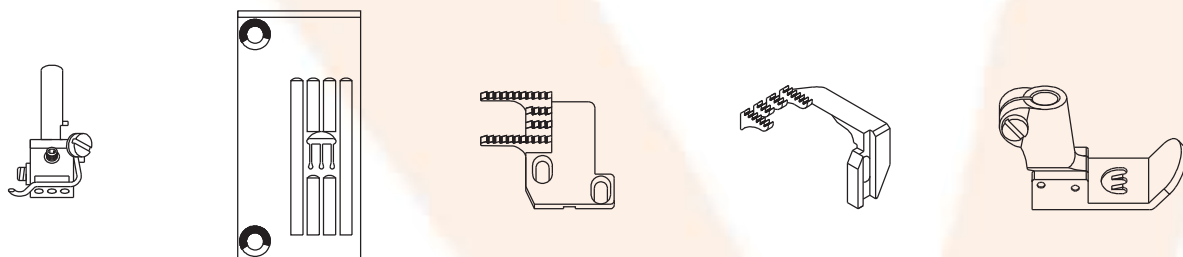

309800-4-01
SA11431

302416-0-10
PA11431

300563-0-12
DT11432

300564-0-11
DT11431

302410-3-11
PS11431

JUEGO DE GOMA 2 AGUJAS

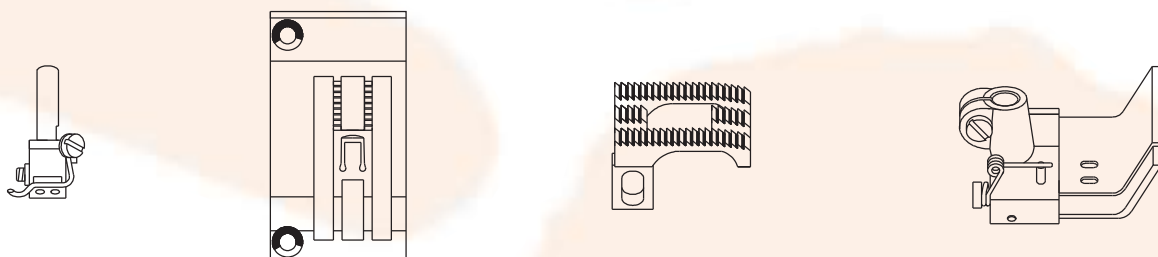

309806-4-00
SA11422

304052-0-10
PA11521

307702-0-00
DT11523

306669-3-00
PS11521

JUEGO DE PUNTILLA SERIE ORO 2 AGUJAS

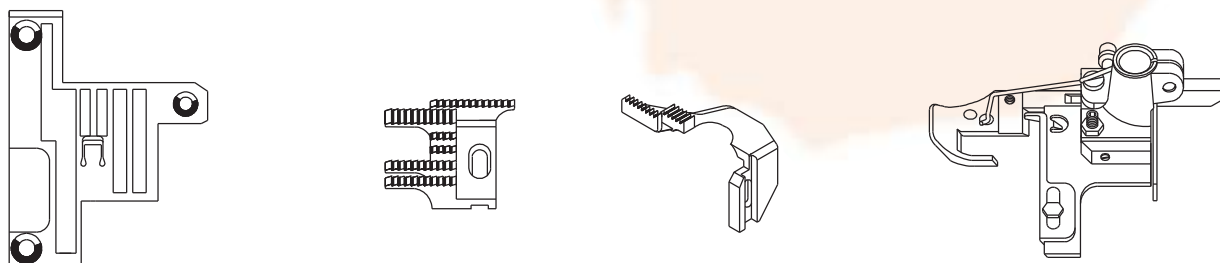

929748-0-00 → 3,5 mm
PA11424
929707-0-00 → 4,5 mm
PA11434

929749-0-00
SS0007

929739-0-00
DT11438

929746-3-01 → 3,5 mm
PS11223
929704-3-00 → 4,5 mm
PS11033



MARCAN

TALLERES MECANICOS, S.L

RIMOLDI

JUEGO DE PUNTILLA SERIE ORO 3 AGUJAS

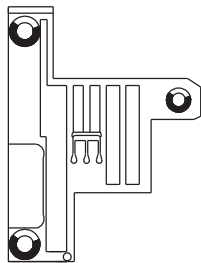

929786-0-00
PA11232

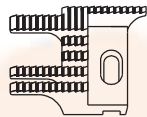

929708-0-00
DT11439

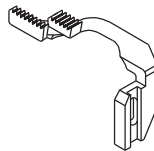

929709-0-00
DT11043

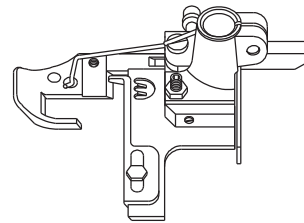

929787-0-00
PS11034

JUEGO DE TIRA SERIE ORO 2 AGUJAS

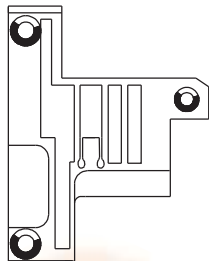

933103-0-00
PA11324

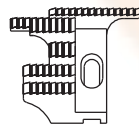

933101-0-00
DT11044

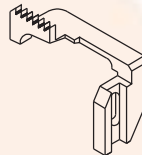

933102-0-00
DT11045

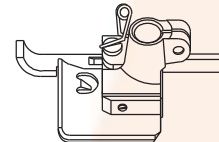

929740-3-01
PS11224

JUEGO ESPECIAL

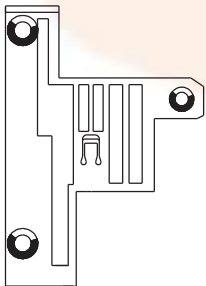

SS0006

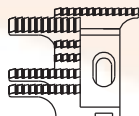

929749-0-00
SS0007

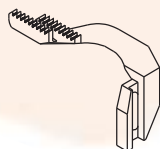

SS0003

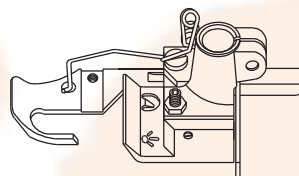

SS0013

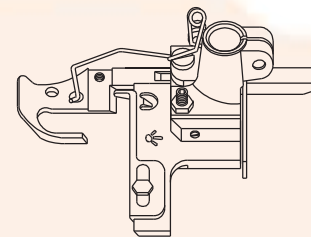

SS0012
PATA PUNTILLA 3,5
SERIE ORO
ZAPATILLA LARGA

JUEGO ESPECIAL

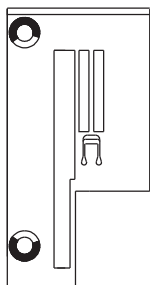

SS0001

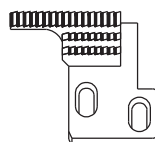

SS0004

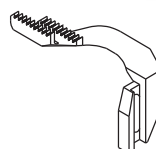

SS0003

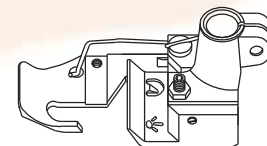

SS0002

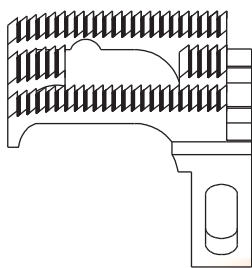

304050-0-10
DT11524

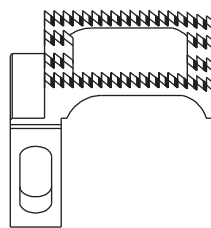

305248-0-00
DT11032

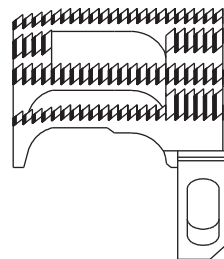

303114-0-10
DT11433

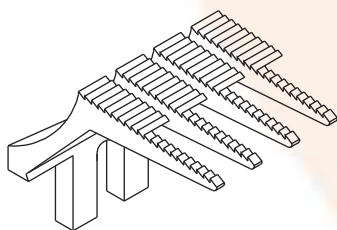

304160-0-10
DT11031

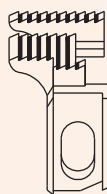

205011-0-10
DT11436



921350-0-11
DT11037

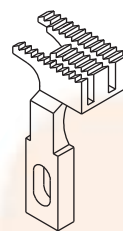

321404-0-00
DT11035

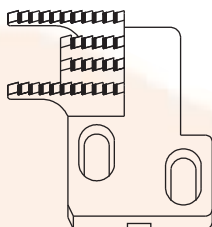

311261-0-00
DT11434

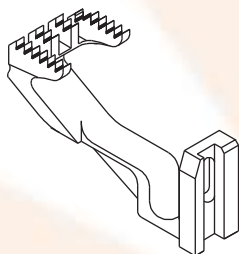

924509-0-11
DT11435

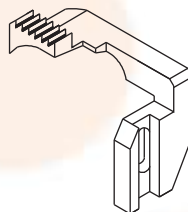

929743-0-10
DT11030

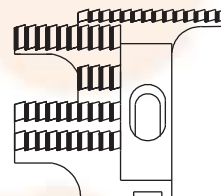

929742-0-10
DT11029

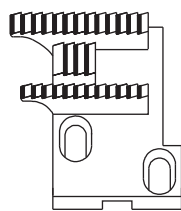

300020-0-10
DT11036

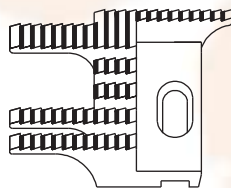

929708-0-00
DT11439

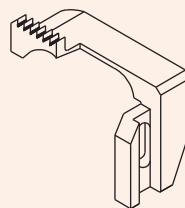

301755-0-20
DT11033

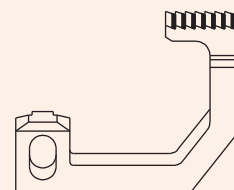

321423-0-00
DT11034

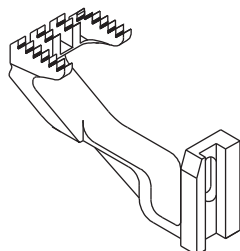

924553-0-11
DT11437

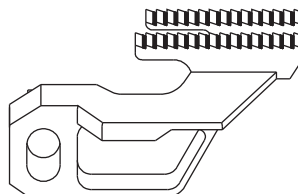

946084-0-00
DT11042

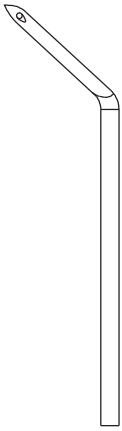

202090-0-10J
AN11027



202091-0-10J
AN11028



202092-0-10J
AN11011



202093-0-11
AN11021
ORIGINAL
202093-0-10J
AN11029



203755-0-12
AN11019
ORIGINAL
203755-0-10J
AN11016



204022-0-10
AN11023
ORIGINAL
204022-0-10J
AN11134



204033-0-10
AN11012
ORIGINAL
204033-0-10J
AN11015



206209-0-00
AN11022
ORIGINAL



208011-0-01
AN11024
ORIGINAL



203005-0-10
AN11025

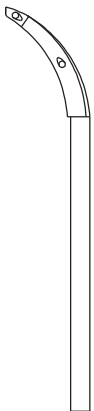

204021-0-10
AN11035
ORIGINAL
204021-0-10J
AN11944

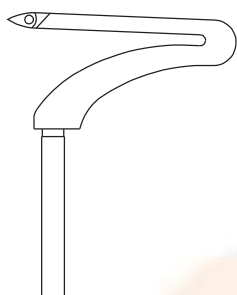

202094-0-13
AN11017
ORIGINAL

202094-0-11J
AN11014

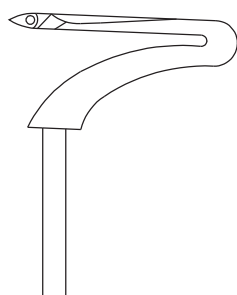

202095-0-13
AN11013
ORIGINAL

202095-0-13J
AN11052

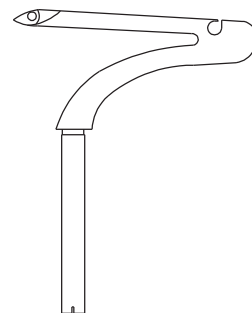

202413-0-13
AN11032
ORIGINAL

202413-0-10J
AN11018

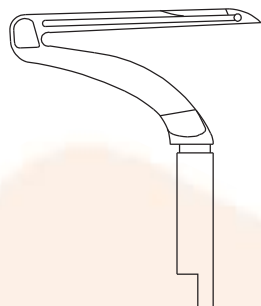

ORION

209264-0-00
AN11133
ORIGINAL

209264-0-00J
AN11132

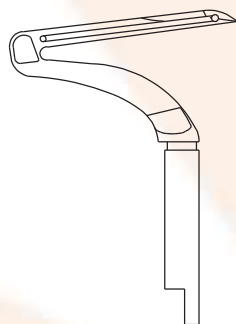

209265-0-01
AN11139
ORIGINAL

209265-0-00J
AN11138

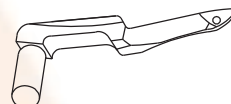

209223-0-00
AN11026
ORIGINAL

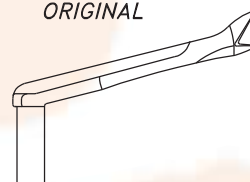

209247-0-00J
AN11135

209247-0-00
AN11037
ORIGINAL

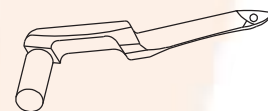

209249-0-00J
AN11137



209248-0-00
AN11140
ORIGINAL

209248-0-00J
AN11136

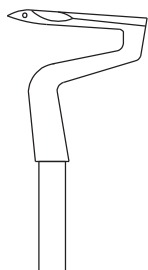

207722-0-00
AN11020
ORIGINAL

207722-0-00J
AN11034

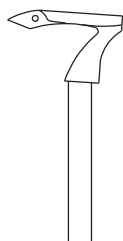

204676-0-11
AN11033
ORIGINAL

204676-0-11J
AN11031



209230
AN11056

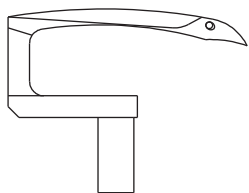

302057-0-13
AN11101
ORIGINAL

302057-0-12J
AN11102

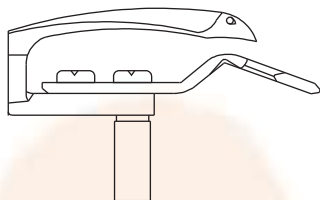

302056-0-10J
AN11100

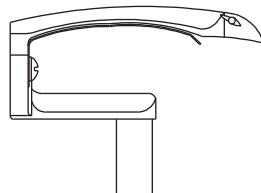

304628-4-12
AN11942

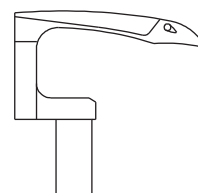

303419-0-12
AN11051

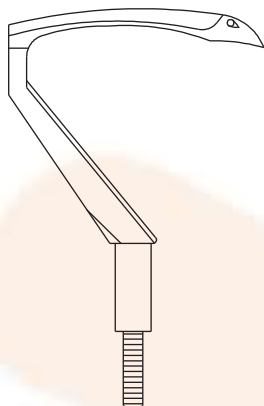

315863-0-01
AN11141

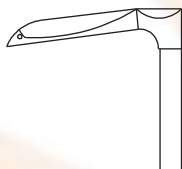

304186-0-11
AN11941
ORIGINAL
304186-0-11J
AN11945

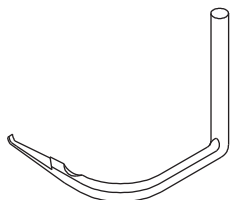

308080-0-00
AN11104
308080-0-00I
AN11105

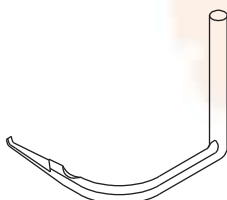

302308-0-10
AN11103

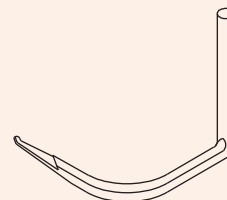

302266-0-10
AN11131
302266-0-00I
AN11130



302808-0-10
CH11208
ORIGINAL
302808-0-10J
CH11201

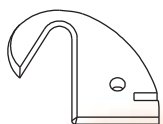

302807-0-10
CH11202

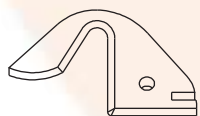

302865-0-11
CH11203



202146-0-10
CH11017
ORIGINAL
202146-0-10J
CH11012



202145-0-10J
CH11024



207015-2-00
CH11019
ORIGINAL
207015-2-00J
CH11014



207016-2-00J
CH110018

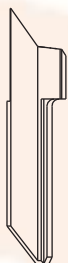

202142-0-10
CH11016
ORIGINAL
202142-0-10J
CH11011
202143-0-10J(DENTADA)
CH11023



203010-0-10J
CH11006



203783-0-10J
CH11005
203783-0-00
CH11022
ORIGINAL



207002-2-00J
CH11013



207006-2-00J
CH110017



207003-2-00J
CH11010

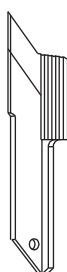

207004-2-00J
CH11015

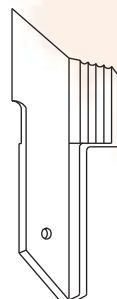

203759-0-10J
CH110013



207000-2-00J
CH11021

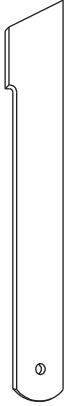

203012-0-10
CH11002
ORIGINAL

203012-0-10J
CH110015



203068J
CH110016

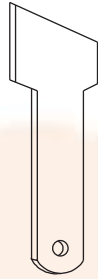

204693-0-11J
CH110012

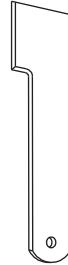

204693-0-10J
CH11004

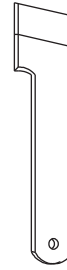

207020-2-00J
CH11003



209593-0-00
CH11018



202194-0-10J
CH11001



304891-0-11
CH11209



920780-0-10
CH11007



920572
CH11008

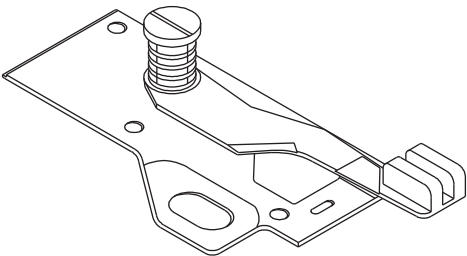

925891-4-00
CH110014

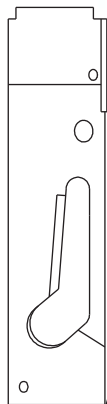

926753-2-01
CH110010



926756-2-01
CH11009

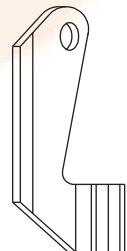

926754-2-01
CH110011



932453-0-00
CH11205
932453-0-00R
CH11199
ORIGINAL

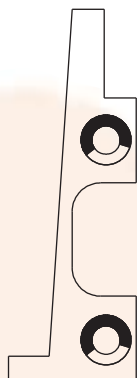

929803-0-00
CH11211
933711-0-00
CH11213

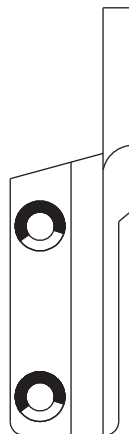

929804-0-00
CH11212



924670-0-11
CH11204



924669-0-20
CH11020



924638-0-11
CH11207



924671-0-10
CH11210



944422-0-00
CH11206



944392-0-00
CH11214



932452
CH11200

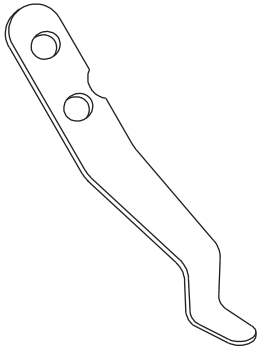

300277-0-10
VA1112220

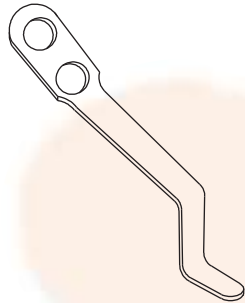

311242-0-10
VA1113220

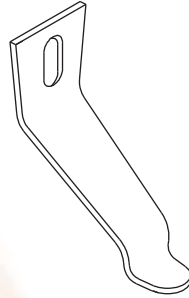

300276-0-10
VA1110221

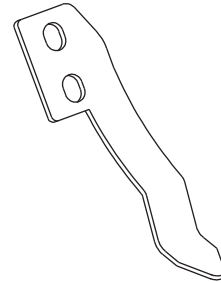

202212-0-10
VA1110222

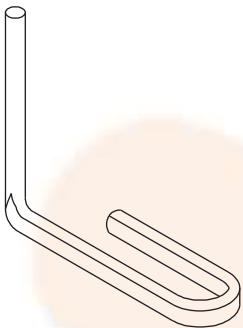

302136-0-10
VA1100091

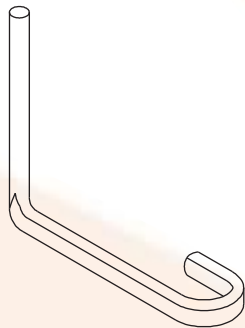

302136-0-12
VA1100092



302143-0-10
VA1112804



308240-0-00
VA1199119

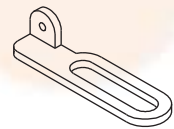

302172-0-10
VA1100802

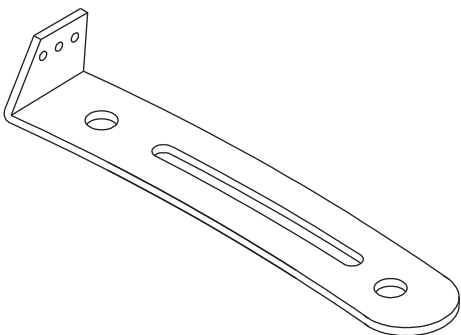

304415-0-10
VA1113803

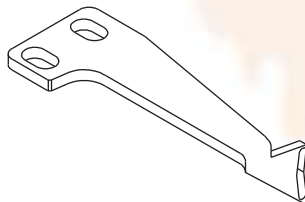

302134-0-10
VA1113100

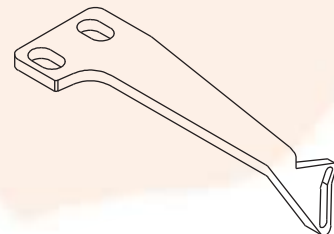

308751-0-00
VA1110101

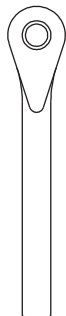

206714-2-00
VA110996

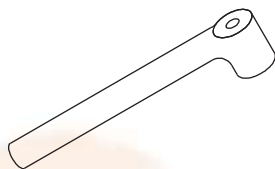

202267-2-13
VA110994



202004-0-10
VA11408012

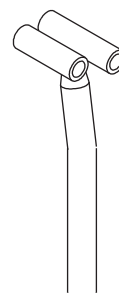

203647-2-13
VA110995

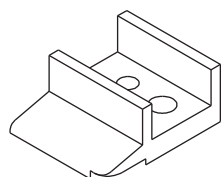

202127-0-10
VA1104002



202131-0-10
VA1100809

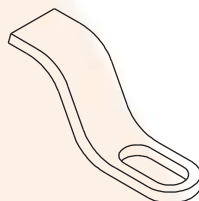

206771-0-12
VA1100093

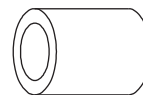

202129-0-10
VA1100806



202130-0-10
VA1100801



206812-0-00
VA11001222



202279-0-10
VA1104007



211748-0-00
VA110040

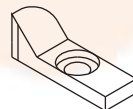

202184-0-10
VA11001221



203357-0-10
VA1101801



202201-0-11
VA11408018

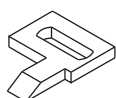

203772-0-10
VA1100121

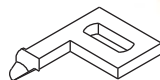

202195-0-10
VA1101120



203569
VA1102121

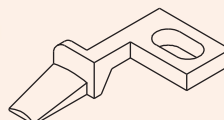

941091-0-00
VA1100064



207542-0-00
VA110993



207540-0-00
VA110992

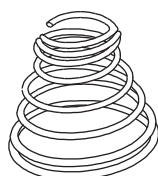

202227-0-10
VA11408017



203142-0-10
VA11408014

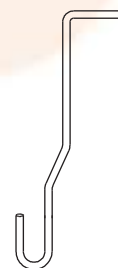

944894-0-00
VA1199809

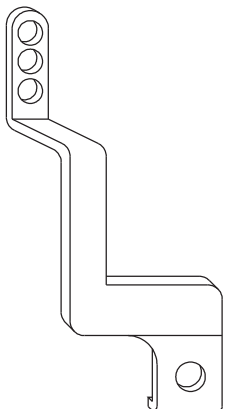

302132-0-10
VA1110092



308501-0-01
VA11108021

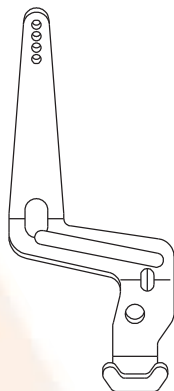

308451-0-10
VA11038

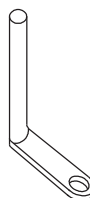

302146-0-10
VA1104009

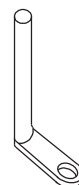

300348-0-10
VA11108022

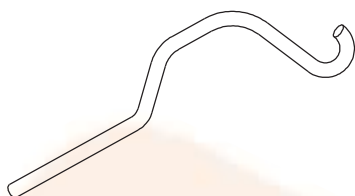

308869-0-00
VA1110811



308137-0-00
VA1140809

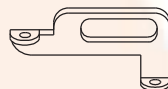

304905-0-10
VA11990143

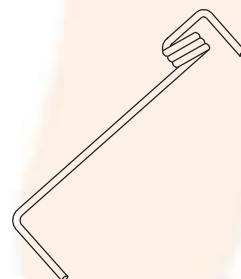

302821-0-10
VA1120122



300119-0-11
VA1110121

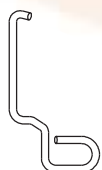

923936-0-00
VA1100241

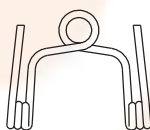

300291-0-11
VA1199808

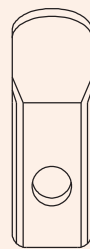

920635
VA1100151

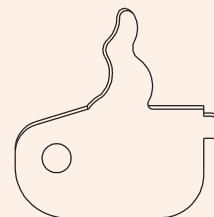

309360-0-00
VA11990804



929307-0-00
VA11108035

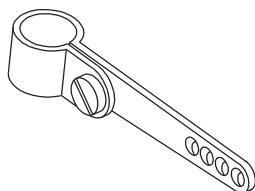

308452-2-00
VA1110091

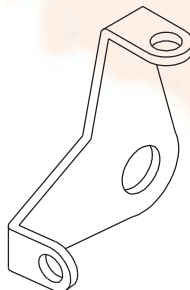

308503-0-01
VA11108028

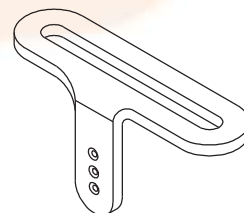

308203-0-01
VA1112100



202658-0-10
VA110034

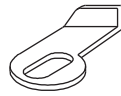

200662-0-10
VA110032

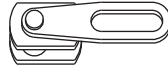

211743-0-00
VA1100054

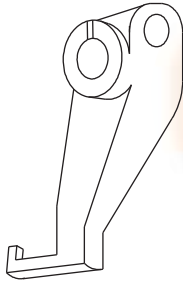

206810
VA1100124

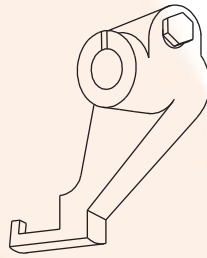

206810-2-00
VA1100125

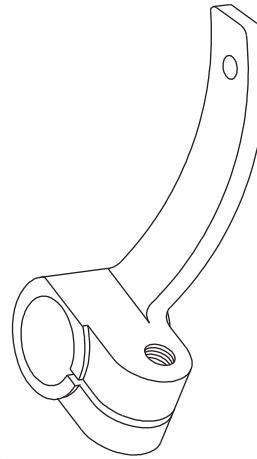

202037-3-10
VA1100051

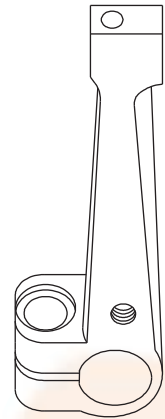

206654-2-00
VA1101061

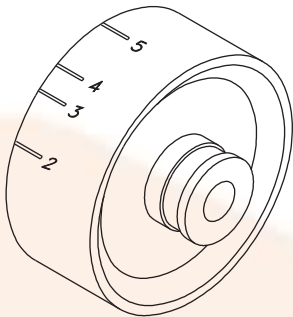

VOLANTE QUICK STOP
202539
VA110080

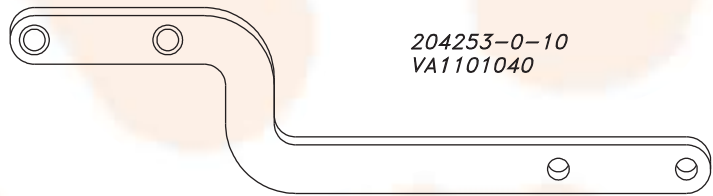

204253-0-10
VA1101040

990986-4-00
VA1100111



211547-0-00
VA11025

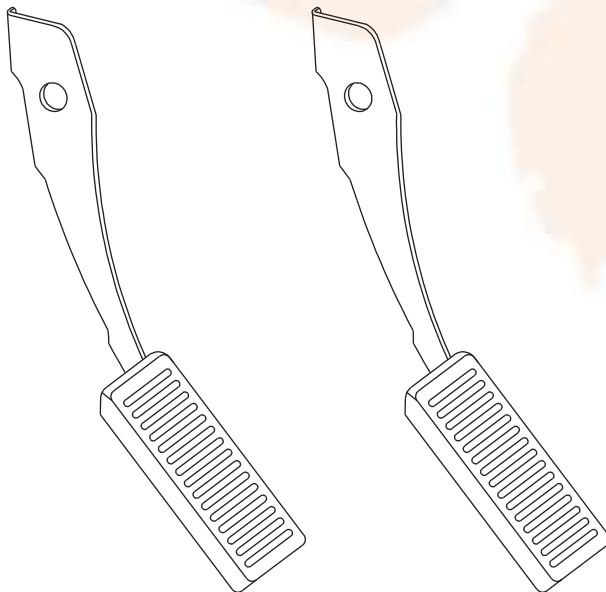

208133-2-00
VA1101110

209524-2-00
VA1100050

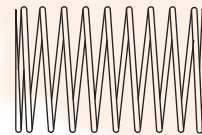

206545-0-10
VA11040

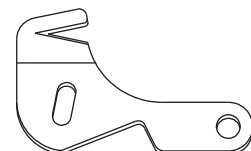

208437-0-00
VA11024

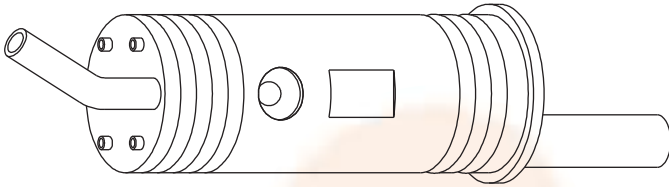

202436-4-10
VA11408010

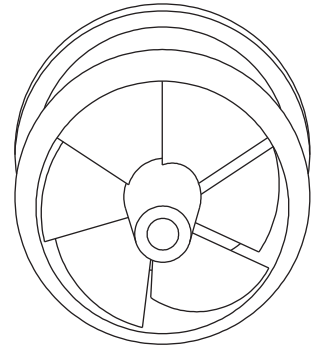

202423-0-10
VA11108027

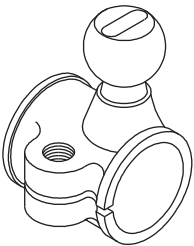

206649-2-02
VA11408015

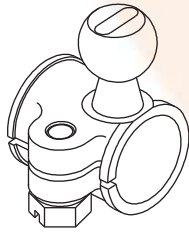

206648-2-02
VA1199156

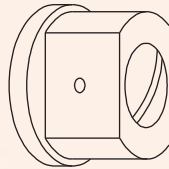

202355-0-10
VA1100052

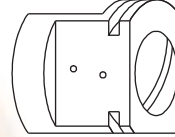

206617-0-00
VA1101041

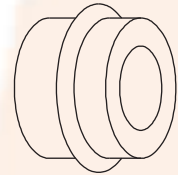

202358-0-10
VA110997

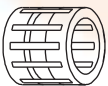

202359-0-10
VA11990142

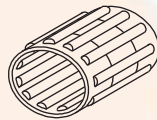

206518-0-00
VA11998014

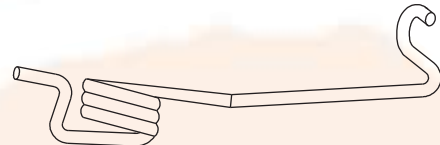

202114-0-10
VA1100112

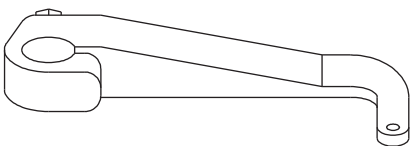

202111-0-20
VA1100113

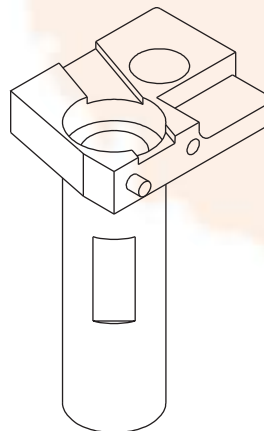

204684-0-10
VA11008010

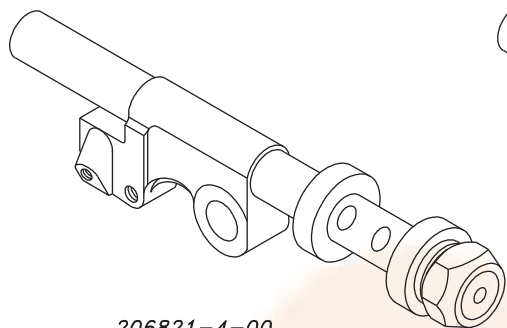

206821-4-00
VA1199137

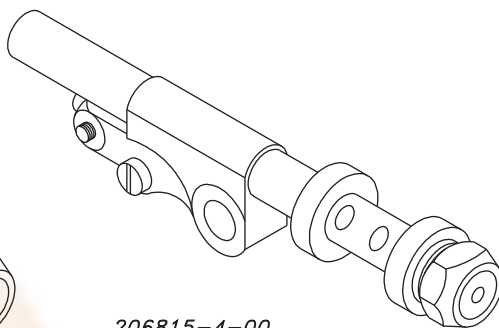

206815-4-00
VA1101091

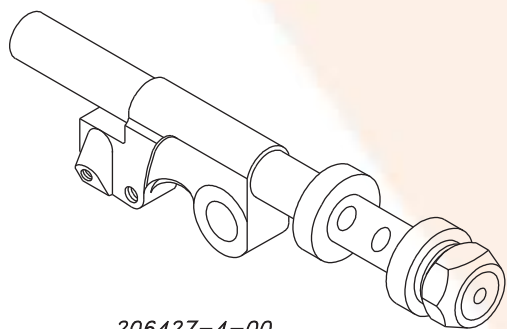

206427-4-00
VA1102091

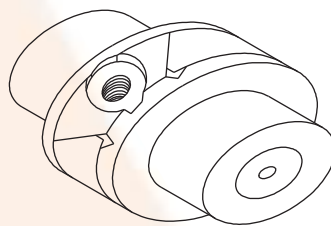

206604-4-01
VA1199136

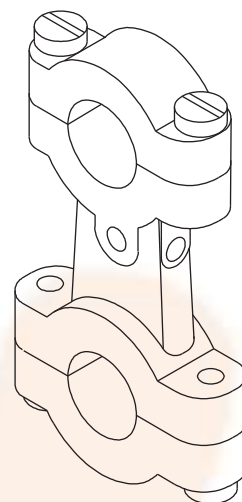

202071-2-10
VA1100141

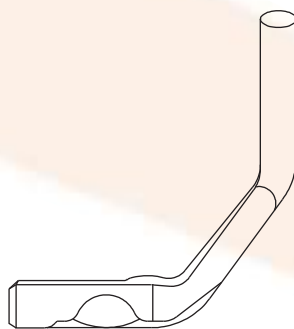

203432-0-10
VA11021

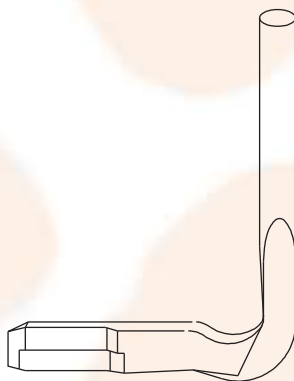

203430-0-10
VA11022



202103-0-10
VA11998013

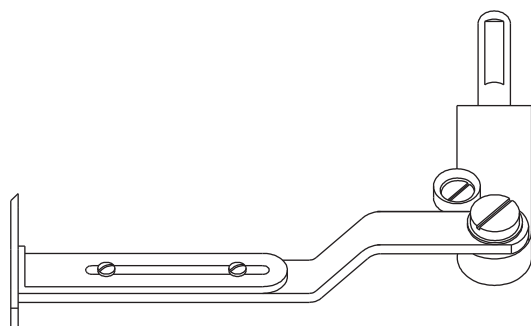

202959-4-10
VA1100081

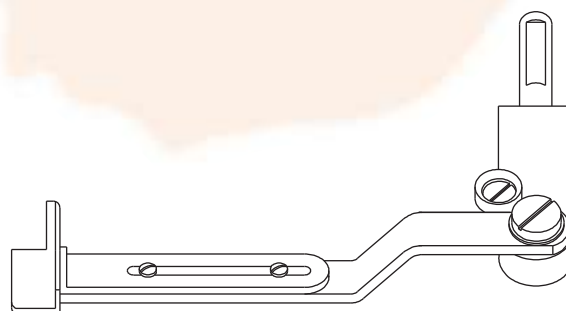

204919-4-10
VA1100082



MARCAN

TALLERES MECANICOS, S.L

RIMOLDI

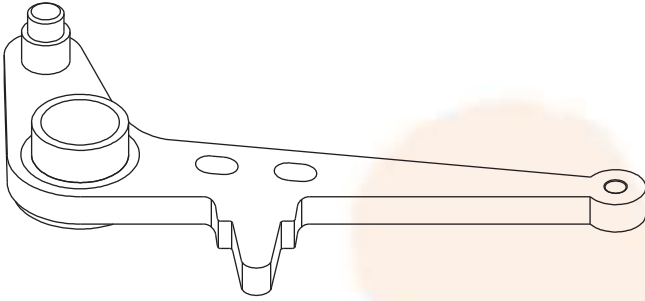

209501-0-11
VA110042

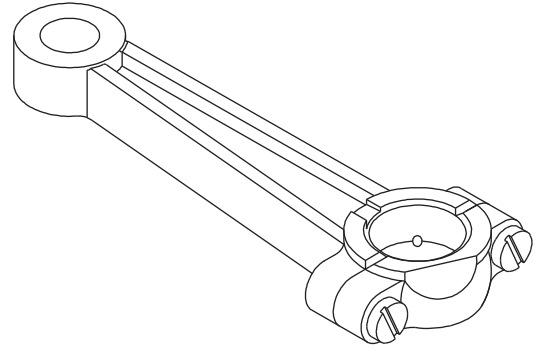

206549-2-00
VA1199155

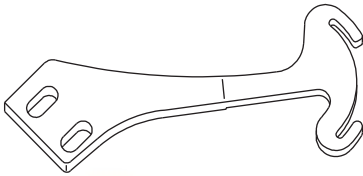

206535-0-00
VA1199814

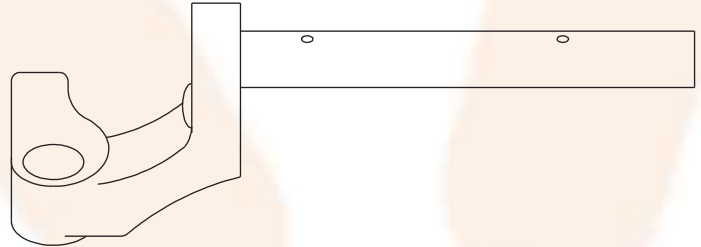

206626-3-00
VA11030

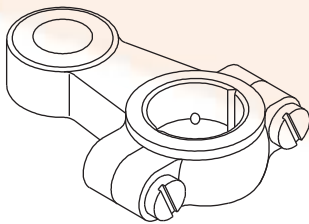

206578-2-00
VA1199154

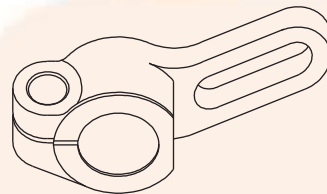

209387-2-00
VA11998011



202032-0-11
VA1199121



200324-0-10
VA119995

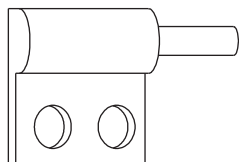

302077-2-10
VA11108031

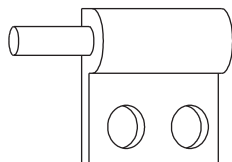

302076-2-10
VA11108030

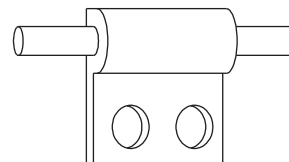

309332-0-00
VA1199127



302235-0-00
VA1140112



308321-0-00
VA1140111

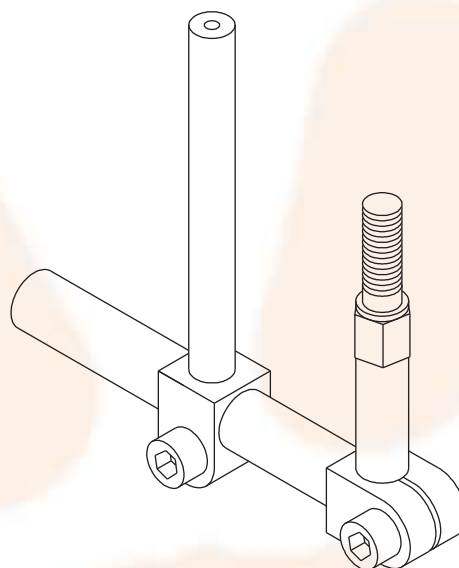

930431-4-10
VA11108019

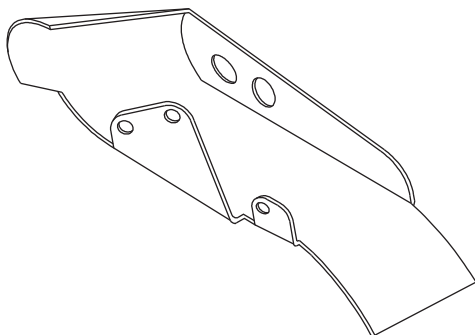

ANTIGUA

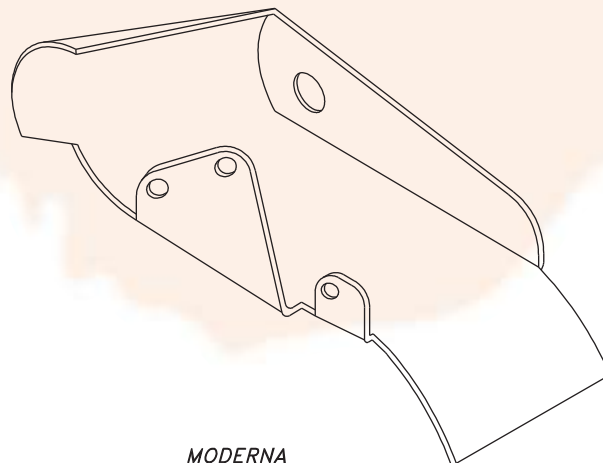

MODERNA

302840-0-10
VA1120803

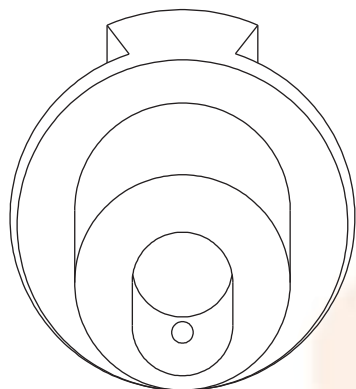

304450-0-10
VA1120141

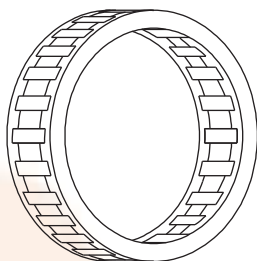

304446-0-10
VA1120142

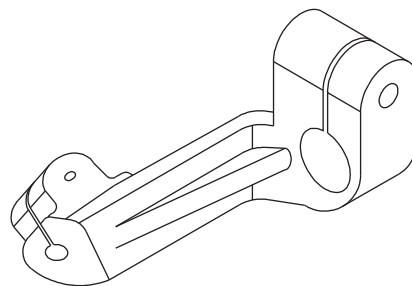

308077-2-01
VA1110063

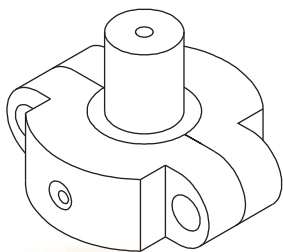

302269-2-10
VA1140802

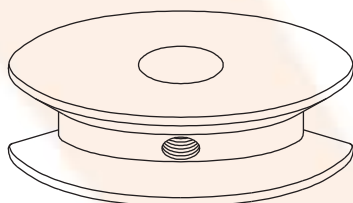

304404-0-10
VA11990818

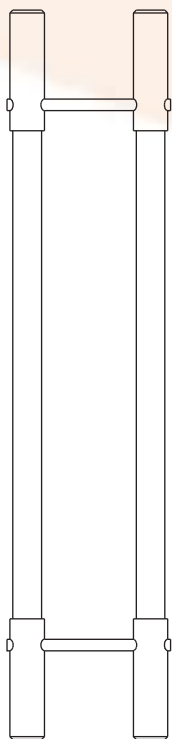

302366-4-10
VA11990141



301604-0-00
TN1110801

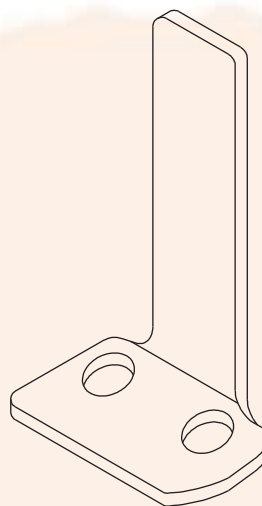

300129-0-10
VA11990822

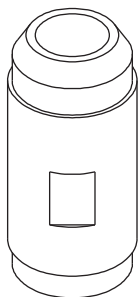

308031-0-00
VA1112093

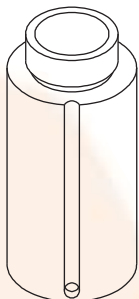

308032-0-00
VA1112094

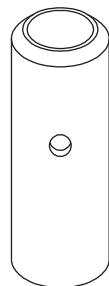

302022
VA1112096

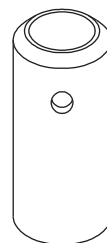

302023
VA1112095

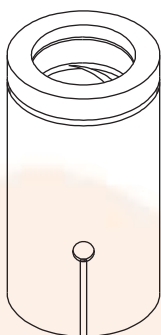

308852-0-00
VA1199106



308009-0-10
VA1100055

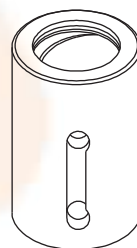

308293-0-02
VA110033



308296-0-10
VA1100058

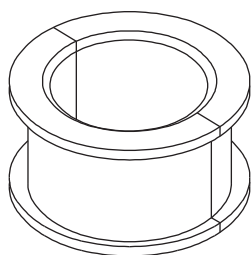

CASQUILLO BIELA
308174-3-00
VA1112140

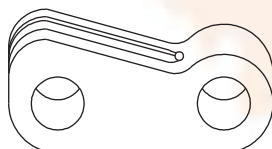

305560-0-10
VA1140141



302019-0-10
VA1140142



302018-0-10
VA1110814

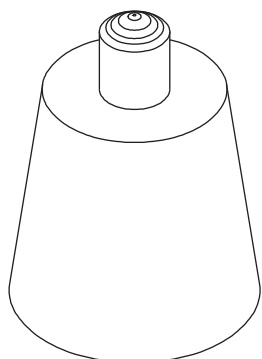

990296-2-10
VA11108012

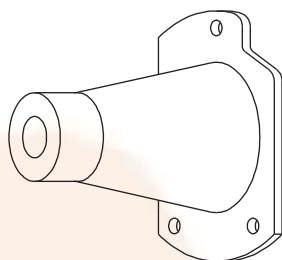

308330-3-00
VA1120801

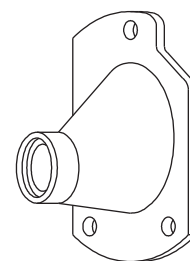

308731-3-00
VA11034

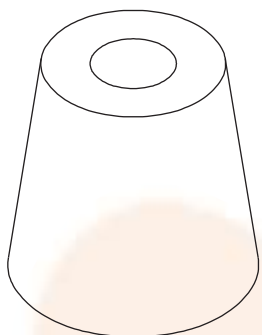

990982-0-00
VA11108013

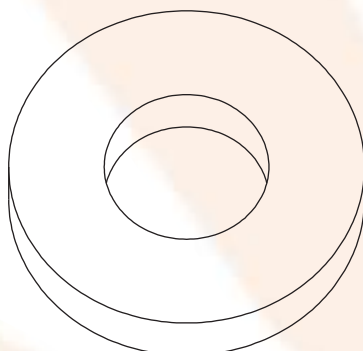

VA40998014

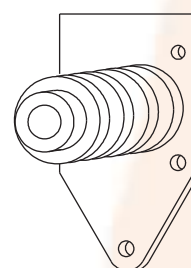

302279-4-10
VA1140801

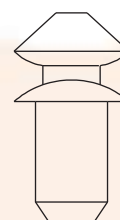

302313-0-10
VA11108014

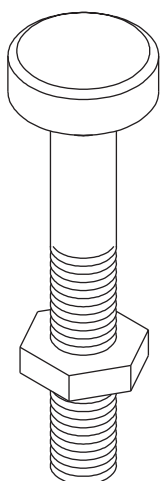

722905-2-00
VA11108016

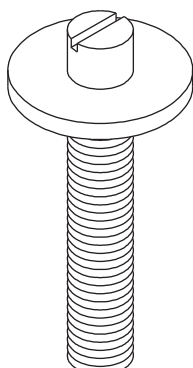

900694-0-11
VA11108015

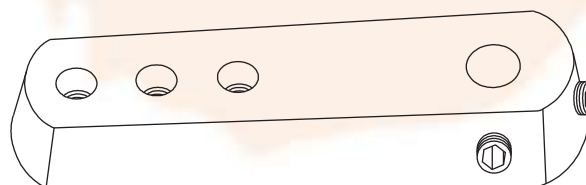

PALANCA MOTOR EFKA
800132-2-00
VA1199122

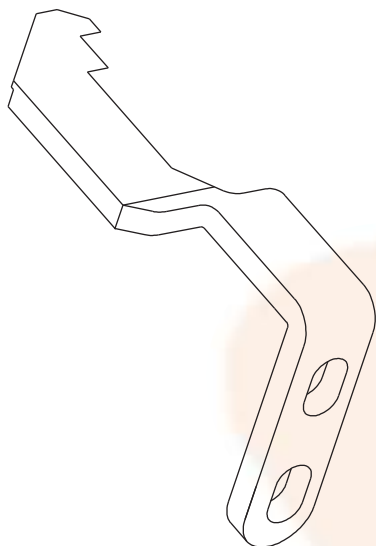

302064-0-10
VA119401

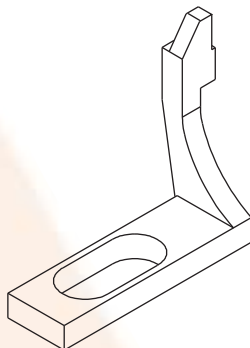

301757-0-10
VA1199125



304187-0-20
VA1114801

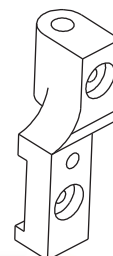

304170-0-20
VA1194231

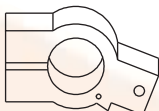

302261-0-10
VA1104006

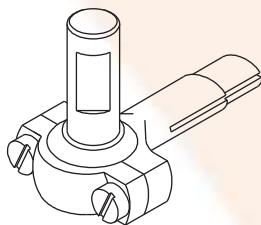

308325-3-00
VA1199133
302861-0-00
VA1199134

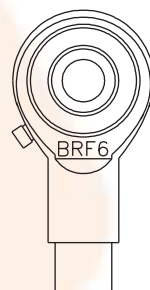

314435-2-00
VA11998016

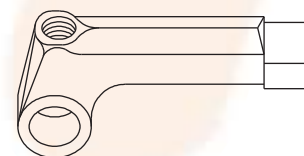

308055-2-00
VA1199143
309616-2-00
VA1100061

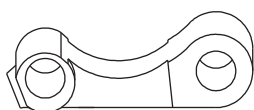

314165-2-00
VA1199124

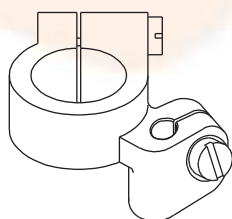

302256-0-10
VA1199142

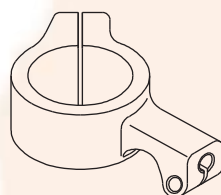

308050-2-00
VA11031

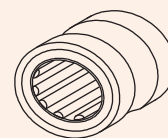

303494-0-10
VA1199140

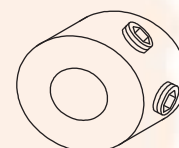

308218-0-00
VA1199151



308119-0-00
VA11990821

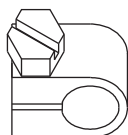

308326-2-01
VA1199144

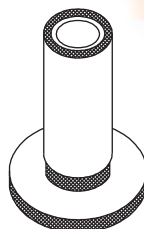

304026-0-11
VA1199101

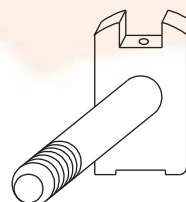

308278-0-01
VA1104003



308041-0-00
VA11990805

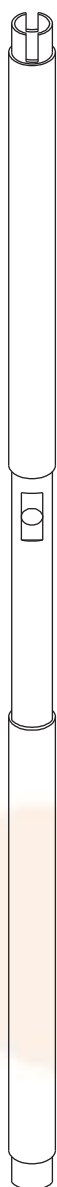

308220-0-00
VA11100910



302020-0-10
VA11108029

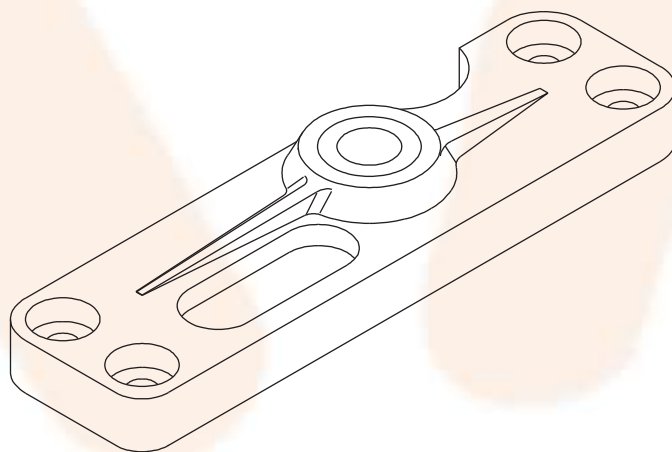

308859-2-00
VA1199104

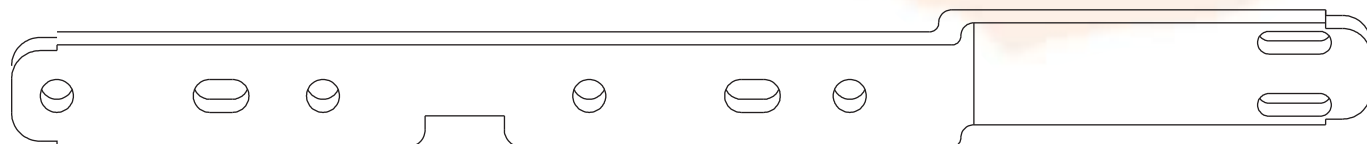

924741-0-10
VA11990817

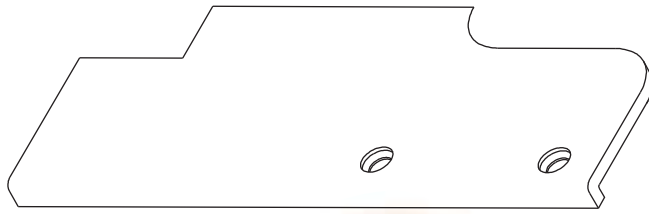

309220-2-00
VA1110220

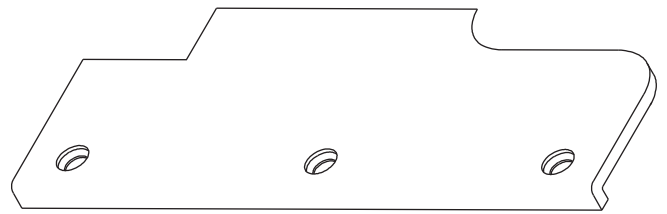

924119-0-00
VA1112802



308556-0-00
VA1199141

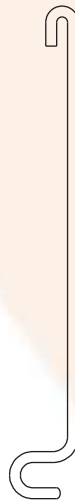

308558-0-00
VA11108011

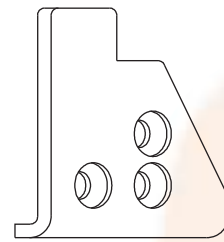

309232-0-00
VA110036

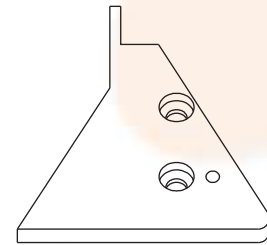

300121-0-10
VA1110223

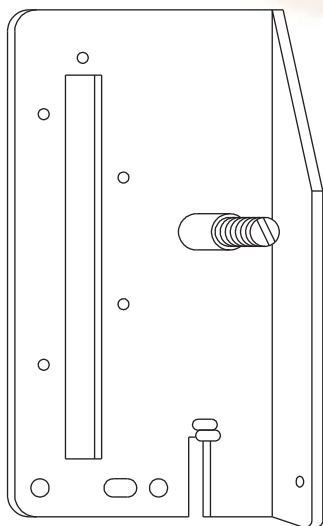

302372-2-10
VA1110807

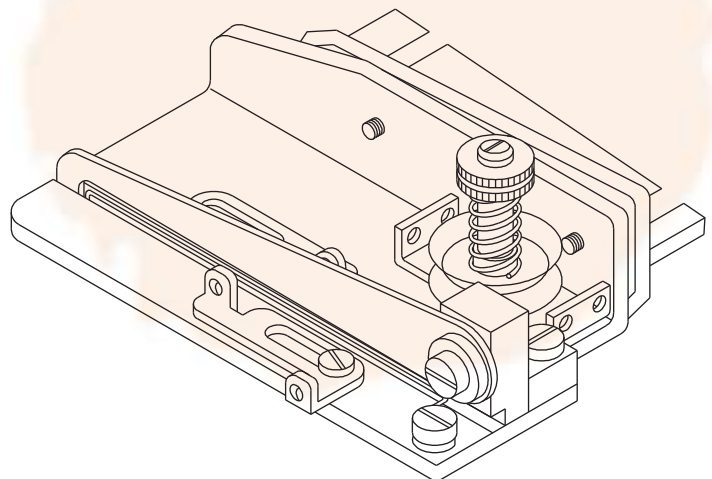

308938-4-00
VA1110062

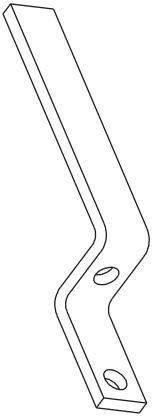

924687-0-10
VA1110804

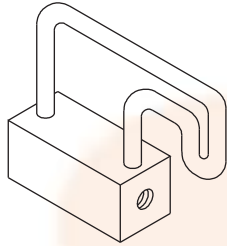

924980-2-11
VA1110803

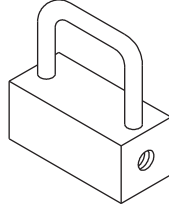

924980-2-00
VA1110802

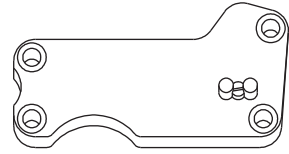

924667-0-11
VA11039

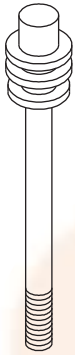

924724-0-11
VA1110801

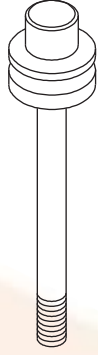

924031
VA1120802



944467-0-00
VA11028

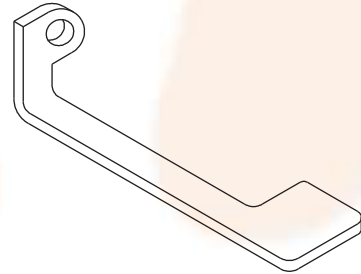

924485-0-00
VA11082



924674-0-10
VA1110813



924675-0-10
VA1110815

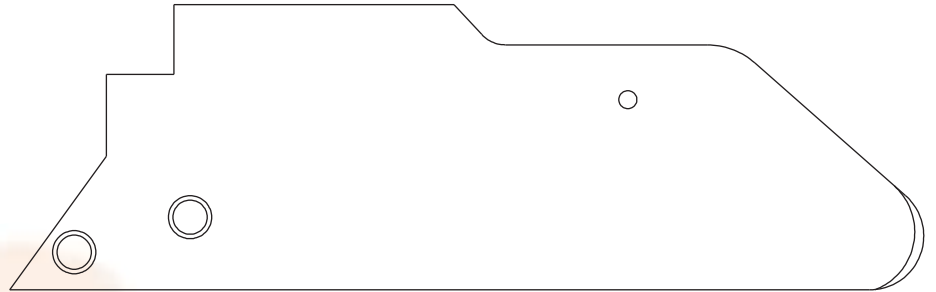

302561-0-10
VA11990222

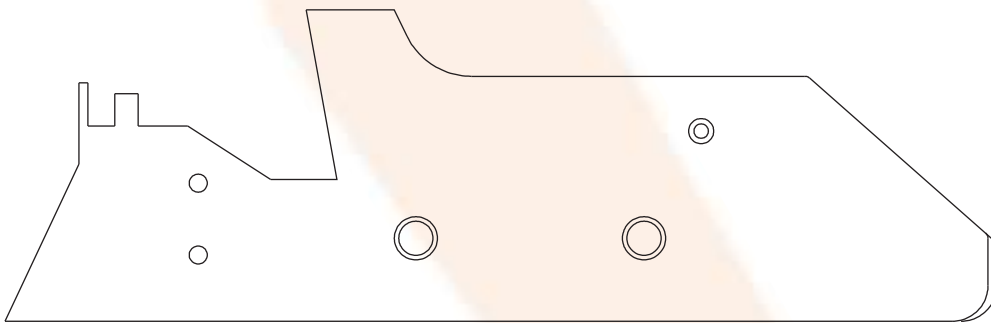

302839-0-10
VA11990221

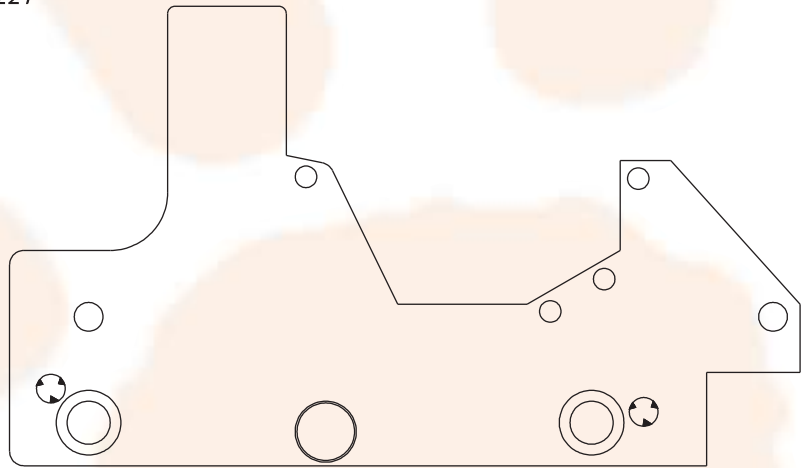

302121-0-10
VA1110011

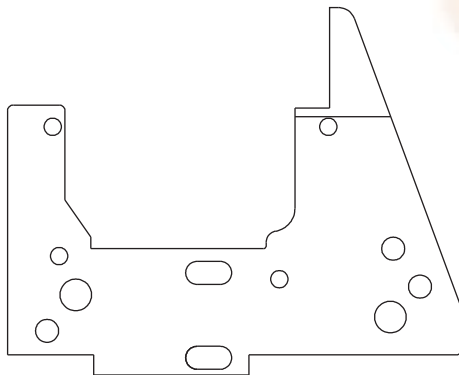

VA1199805

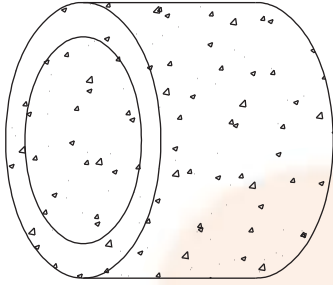

206559-0-01
VA110991

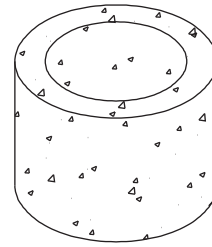

308206-0-00
VA1199128

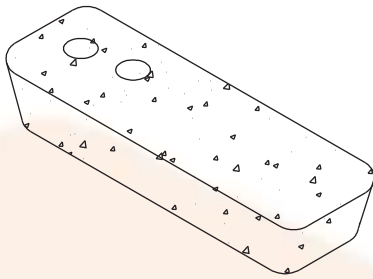

307991-0-00
VA11990824

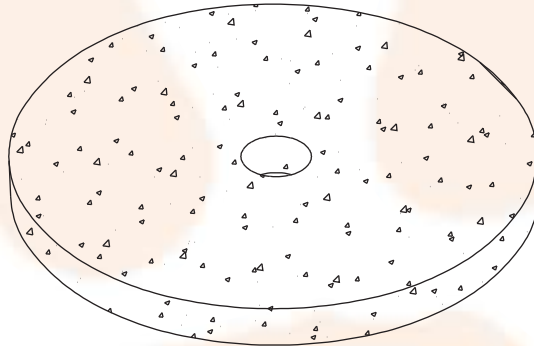

202452-0-10
VA11408013

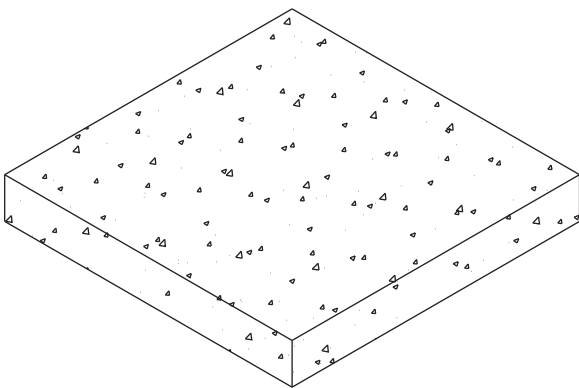

209617-0-00
VA1199129

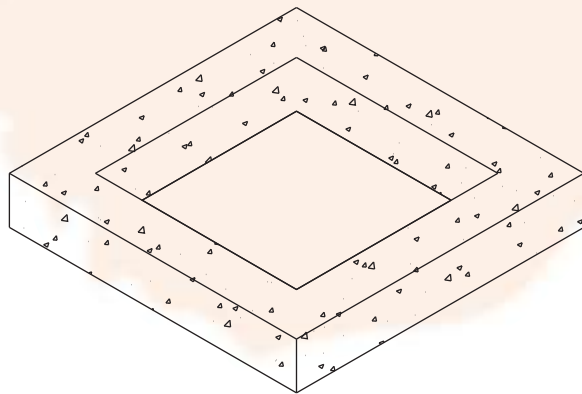

209618-0-00
VA1199130

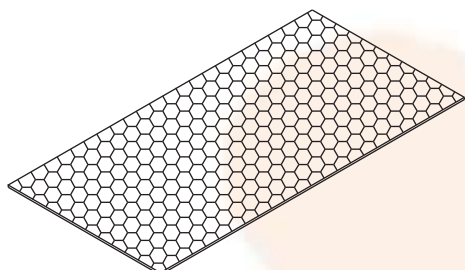

631690-0-20
VA1100070

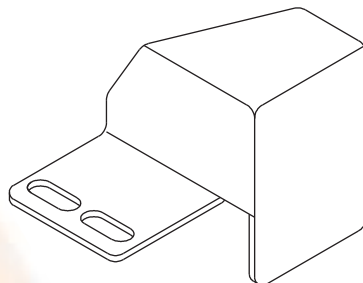

929830-0-00
VA1100066

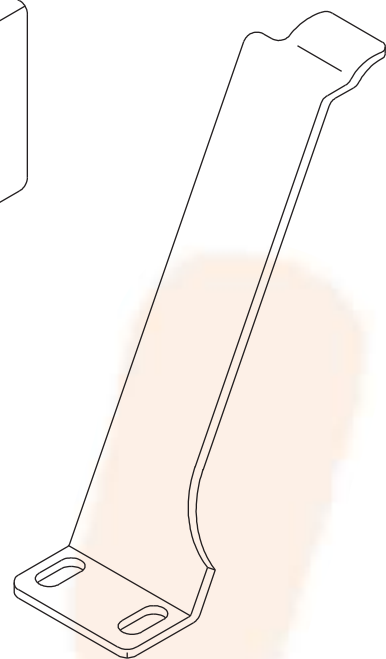

929814-0-00
VA1100067

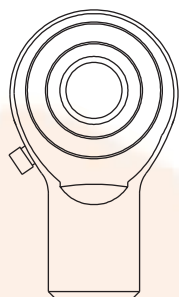

931769-0-00
VA1100068

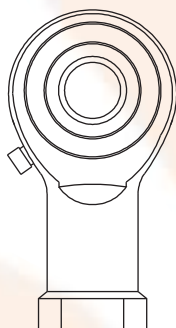

929832-0-00
VA1199816



ACCESORIOS JUEGO DE COSTURA ESPECIAL

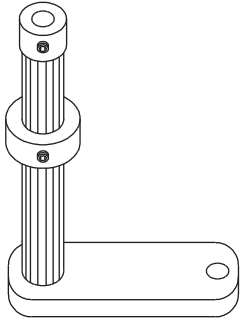

SS0010

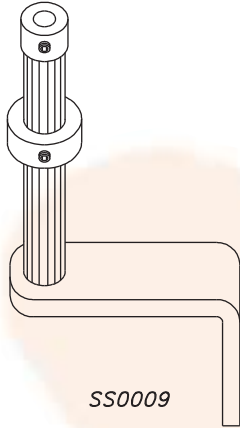

SS0009



SS0008

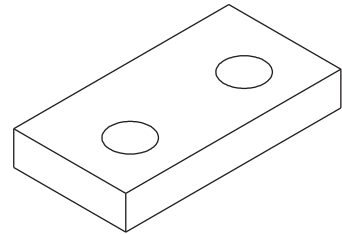

SS0005

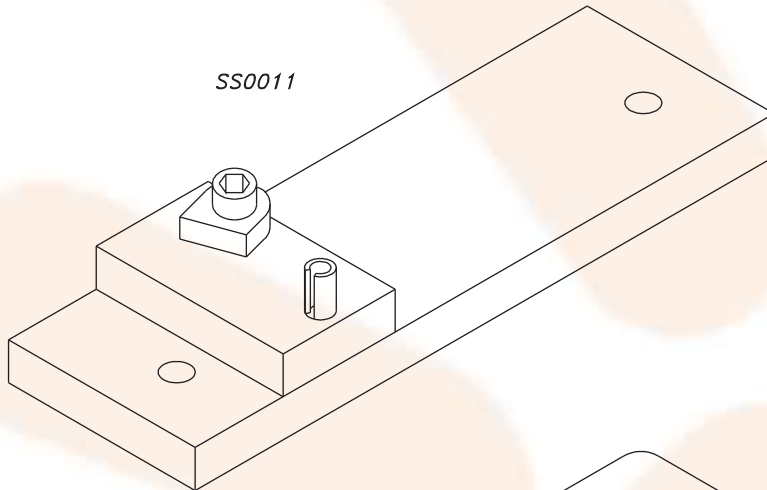

SS0011

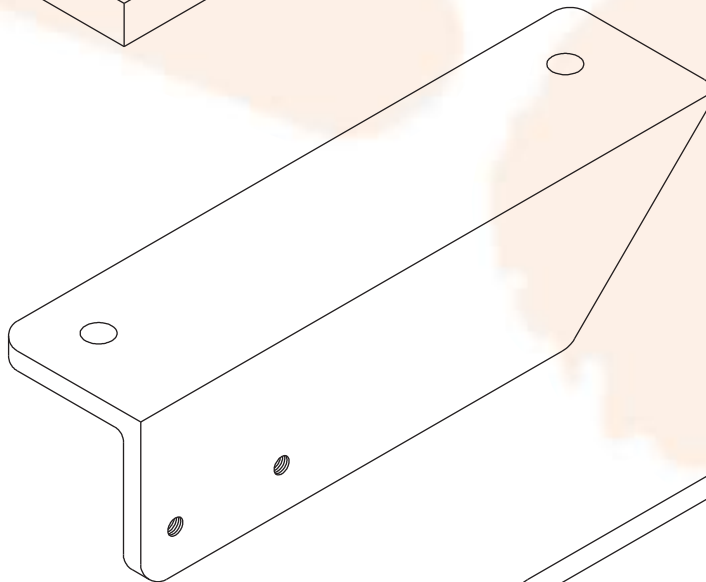

SS0014

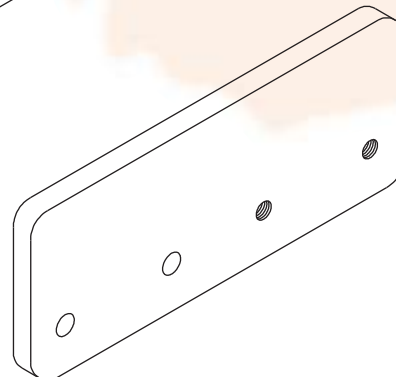



OWERLOCK



FIGURA	REFERENCIA	CODIGO
1	206747-0-01	VA11008014
2	206754-0-00	VA11008013
3	300218-0-10	VA1100808
4	202556-0-00	VA11108036
5	202228-0-10	VA11008012
6	202229-0-10	VA11108032
7	202558-0-00	VA11108026

206342-4-00
VA1110812

PLANA

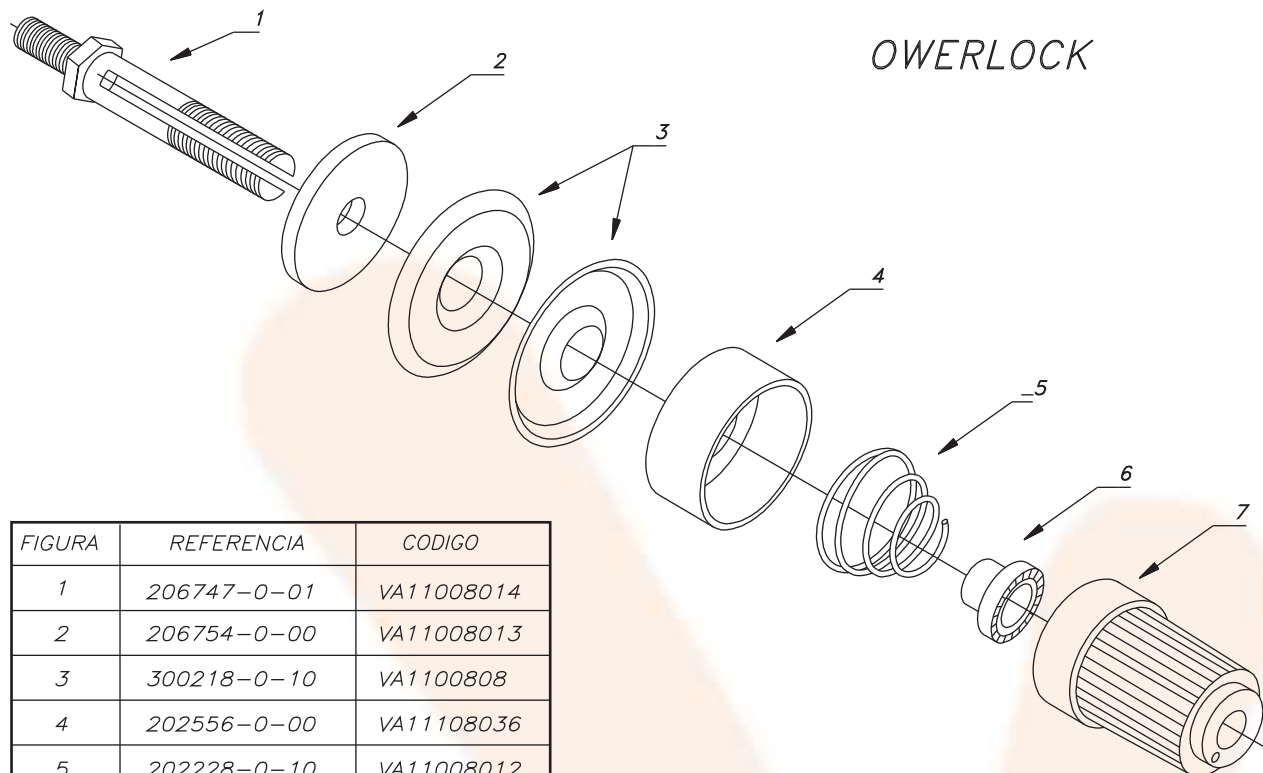

FIGURA	REFERENCIA	CODIGO
1	308505-0-00	VA1110808
2	300218-0-10	VA1100808
3	308507-0-00	VA11108034
4	202556-0-00	VA11108036
5	200710-0-10	VA11108025
6	202229-0-10	VA11108032
7	202558-0-00	VA11108026

308518-4-00
VA1140803



206795-0-00
VA1100804

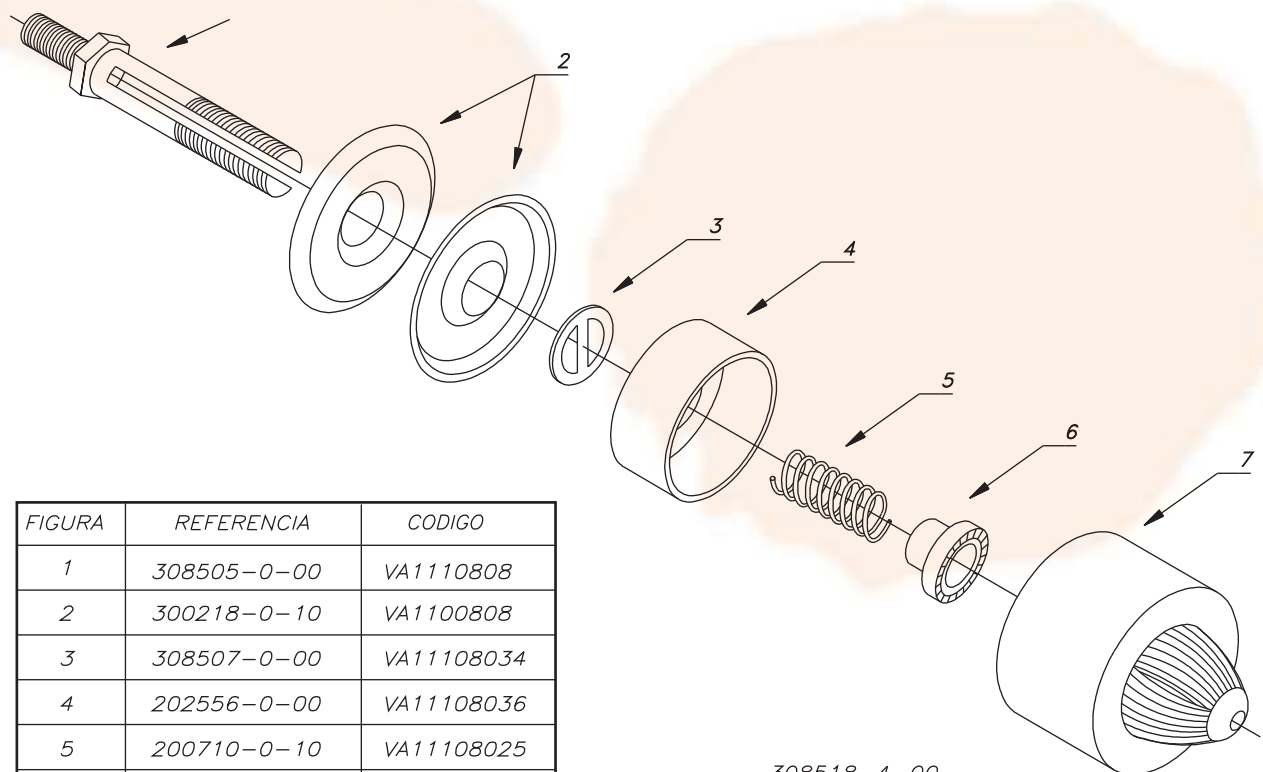
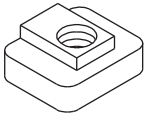
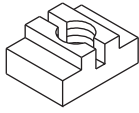

206799-0-00
VA1100805



707241-0-00
VA11108033



703005-0-00
TN1150008



300387
VA1100153

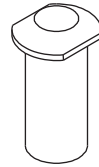

206622-3-01
VA110999

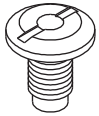

202529-0-10
VA110998

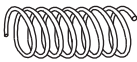

204938
VA1100152

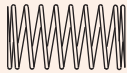

200714-0-10
VA1199131



923918-0-01
VA1100242

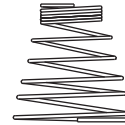

202681-0-10
VA11032

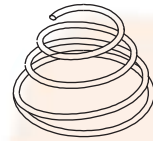

308860-0-00
VA11023

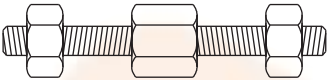

302570-0-10
VA1110061

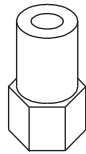

300351-0-11
VA11990808



704309-4-00
VA11990809



300352-0-10
VA1199807



308042-0-00
VA11990806

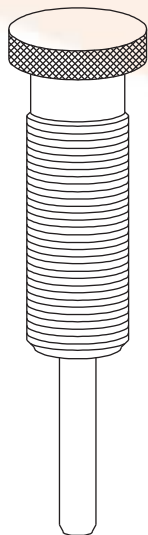

302060-0-11
VA1104001



929831-0-00
VA11998015



300310-0-10
VA11990812

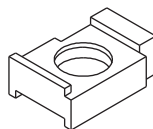

301758-0-10
VA1199126



990310-0-10
VA1199148



990983-0-00
VA1199146

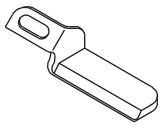

302773-0-11
VA11027



924484-0-10
VA11037

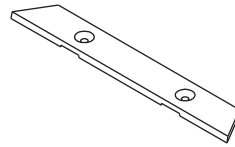

311018-0-00
VA110031



308113-0-00
VA11044

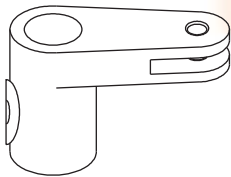

308059-0-00
VA1199100



308057-0-00
VA1199815

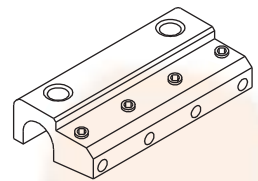

304835-0-10
VA1199822

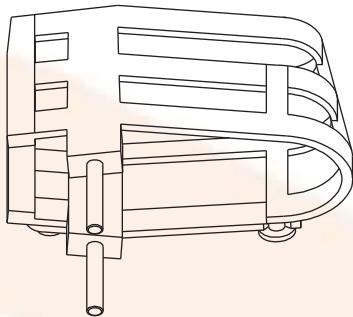

313375-0-01
VA1104008

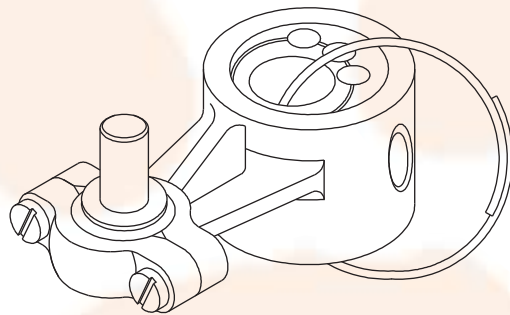

310353-4-00
VA11108024



308333-0-00
VA11042

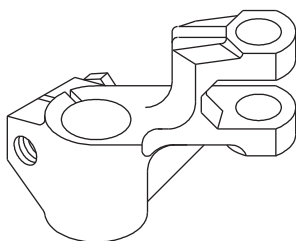

308036-2-00
VA1199080



315799-0-00
VA1199105



990311-0-10
VA1199150



309302-2-00
VA1110224



931840-2-00
VA1100065



931841-2-00
VA1100060



CURRON PULEN PUNTILLA

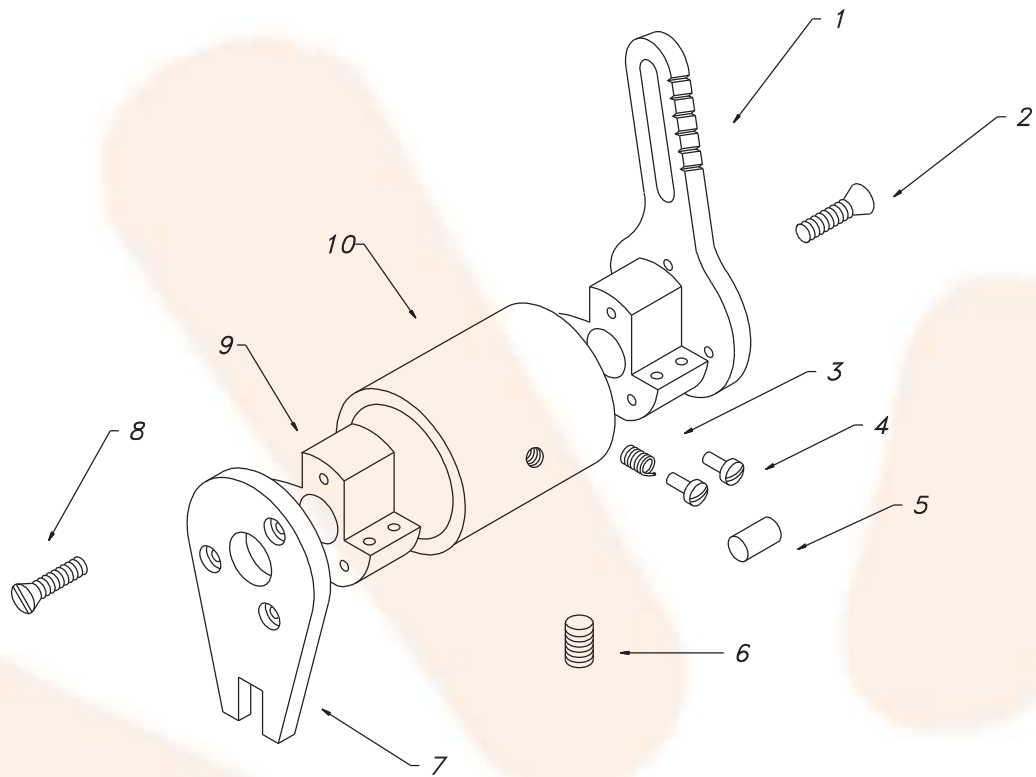

MARCA	N. PIEZA	CODIGO
1	304084-0-10	MR111
2	724471-0-00	TN1120801
3	304477-0-01	MR112
4	304478-0-00	MR113
5	301527-0-10	MR114
6	729043-2-00	TN1120802
7	203928-0-10	MR115
8	724471-0-00	TN1120801
9	301523-0-10	MR116
10	304430-0-10	MR117

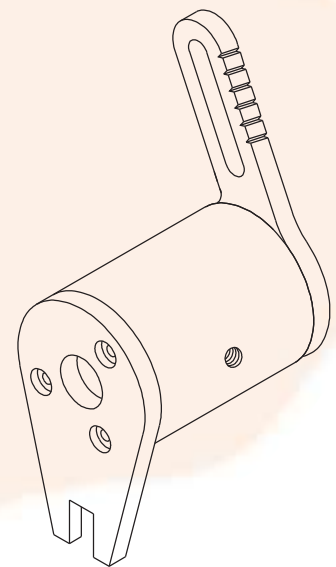

304431-4-11
MR11



CORTANTES

CORTANTE MANUAL

MR7102
921754-0-11

MR7101
921756-0-12

MR72
DIS. 104 Corte útil.....45 mm

CORTANTE NEUMATICO

MR 7102
921754-0-11

MR 7101
921756-0-12

CM.500
VA4099809

CL-126-A
VA4099808

VA4099807

MR71
927690 Corte útil.....50 mm

**CORTADOR NEUMATICO
PARA OWERLOCK**

MR 3102
926642-0-00

MR 3101
926643-2-00

MR31
926648-4-00



MARCA	N° PIEZA	N° PIEZAS
1	920780-0-10	CH11007
2	721421-0-00	TN1100152
3	920774-0-10	AC110002
4	920782-0-10	AC110005
5	920785-0-10	AC110007
6	203231-0-10	TN1100151
7	920778-0-10	AC110006
8	100458-0-10	TN1100153
9	920755-0-10	AC110001
10	920753-0-10	AC110003

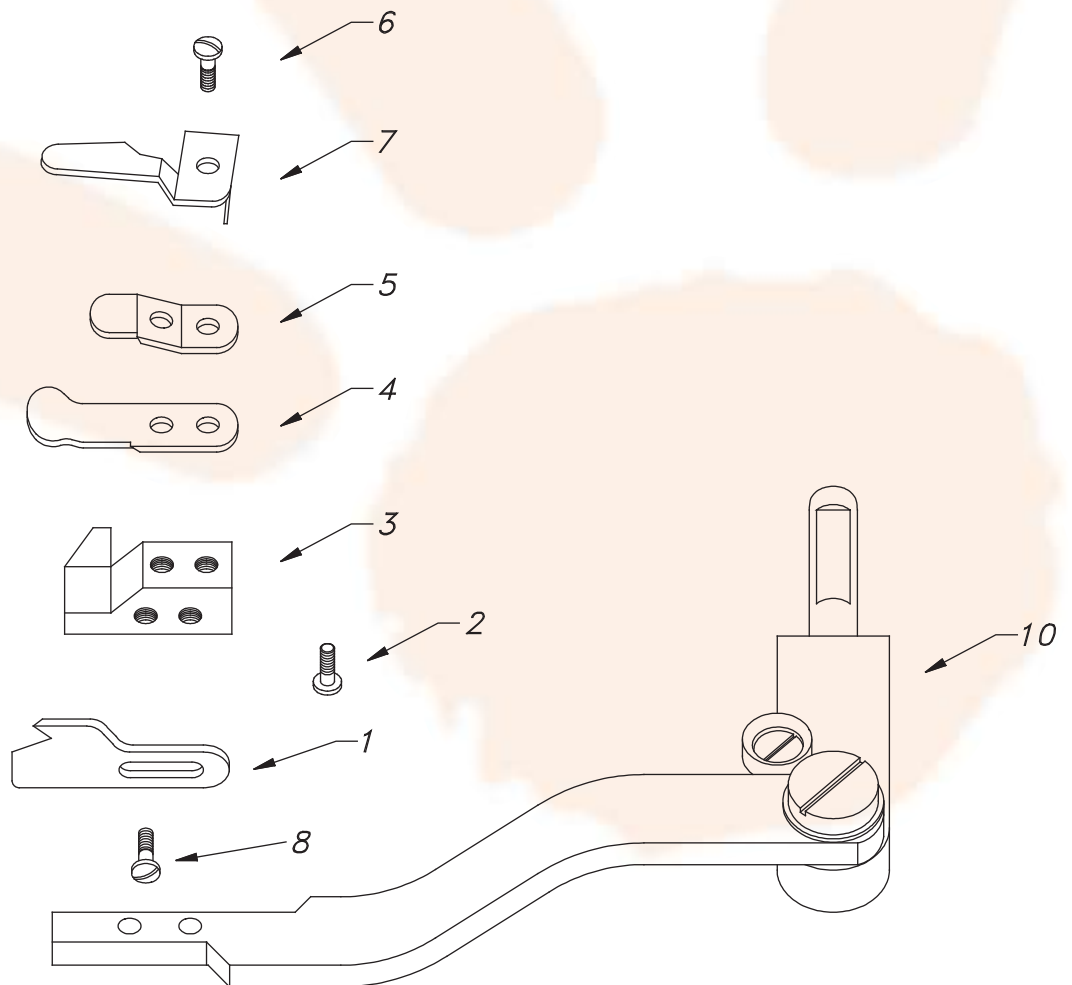

920776-4-10
AC11002



FRUNCIDOR OWERLOCK

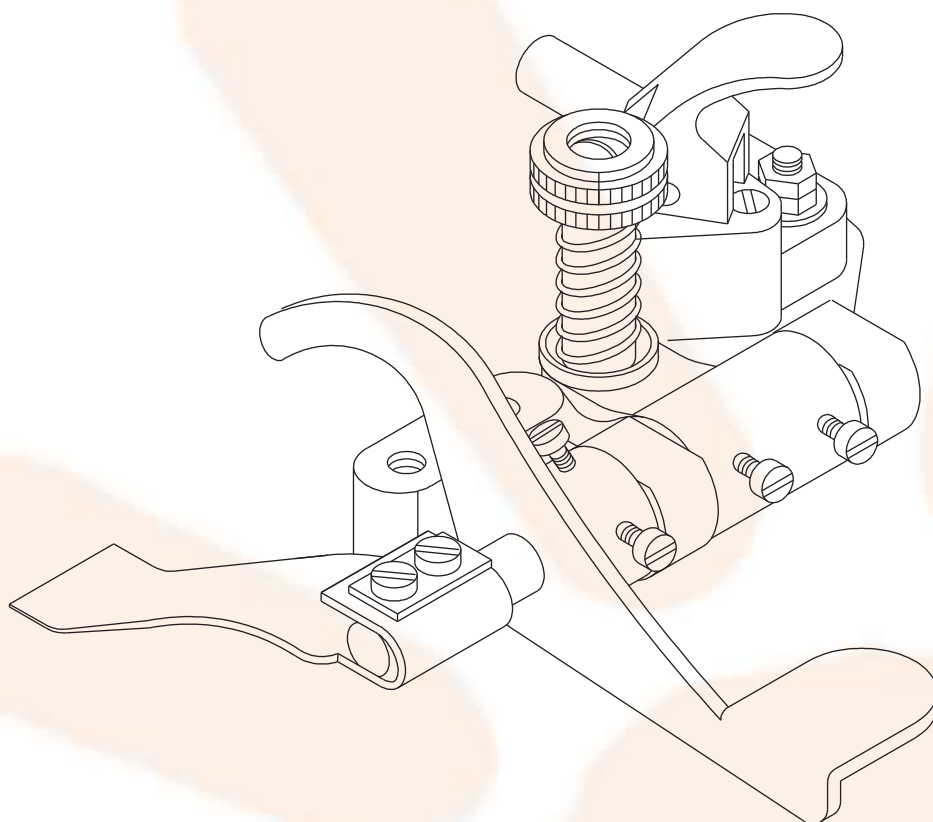

204915-4-12
MR21

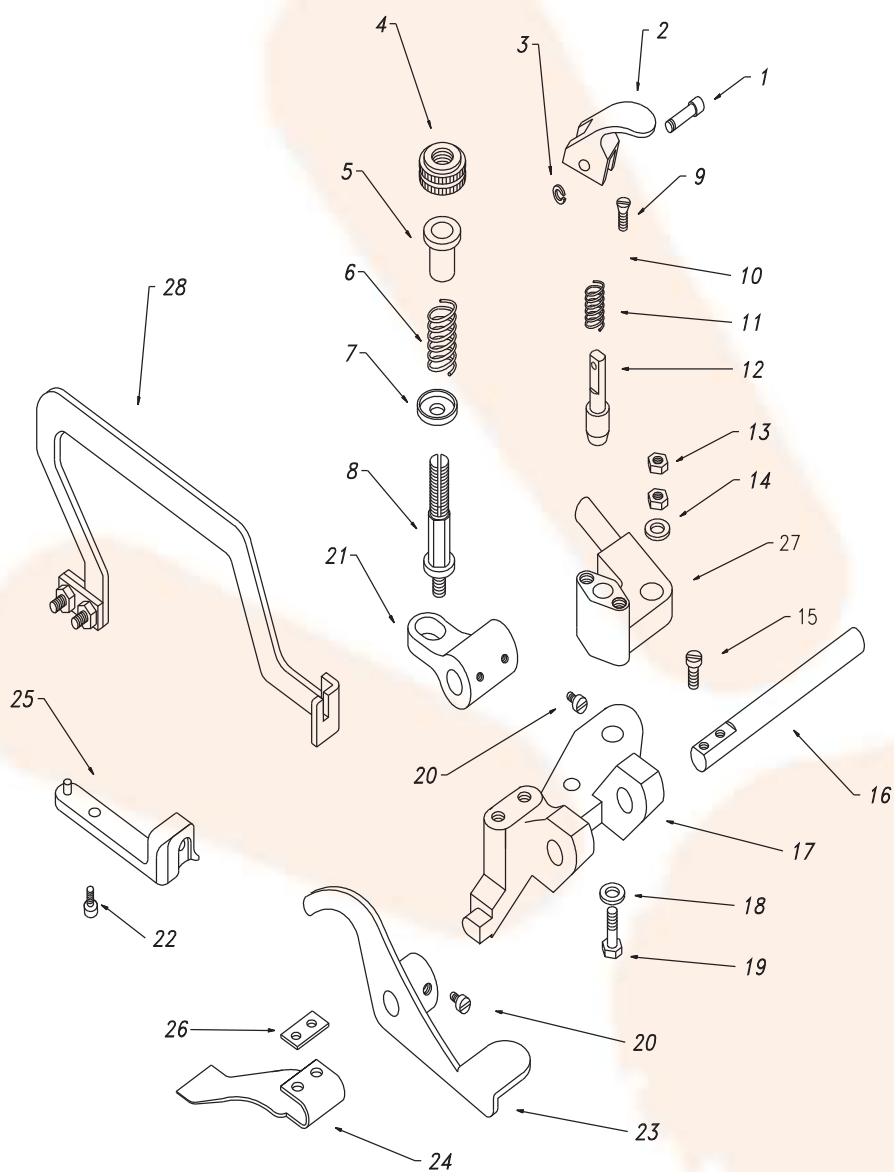

NUMERO	REFERENCIA	CODIGO
1	202100-0-10	MR2101
2	206909-0-00	MR2102
3	700205-0-00	TN1100806
4	200699-0-10	TN1100807
5	200074-0-10	MR2103
6	204937-0-10	MR2104
7	200821-0-10	MR2105
8	200698-0-10	MR2106
9	744533-0-00	TN1100808
10	204935-0-10	MR2107
11	204938-0-10	MR2108
12	204936-0-10	MR2109
13	746021-2-00	TN1100809
14	704216-2-00	TN11008010
15	741675-2-00	TN11008011
16	204918-0-10	MR2110
17	204914-0-10	MR2111
18	704424-2-00	TN1100805
19	204934-0-10	TN1100804
20	721434-2-00	TN11008012
21	204926-0-10	MR2112
22	721443-2-00	TN11008017
23	204924-2-10	MR2113
24	204916-0-10	MR2114
25	203193-2-10	MR2115
26	204964-0-00	MR2116
27	204927-0-10	MR2117
28	206923-0-01	MR2118



DISPOSITIVO 932450-4-00

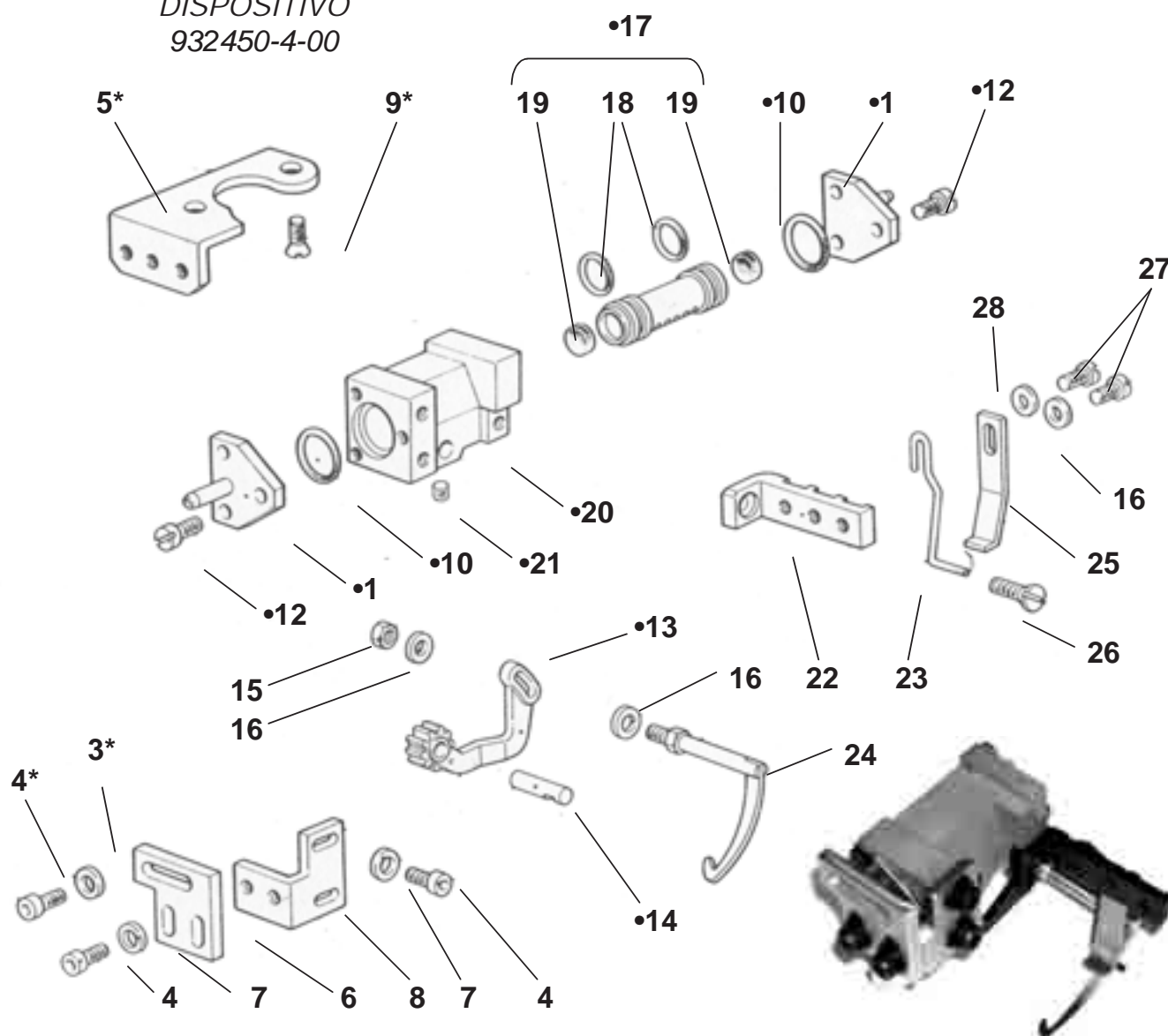

Fig. N°	Referencia	Cantidad
1	932450- 4- 00	1
2	944895- 4- 01	1
3	704106- 2- 00	2
4	722411- 2- 00	6
5	932451- 0- 00	1
6	944768- 0- 00	1
7	704106- 2- 00	4
8	944769- 0- 00	1
9	725611- 2- 00	2
10	701017- 0- 00	2
11	924387- 2- 00	2
12	741634- 2- 00	6
13	924369- 2- 10	1
14	924356- 0- 10	1

Fig. N°	Referencia	Cantidad
15	746002- 2- 00	1
16	704302- 4- 00	3
17	924367- 2- 13	1
18	701009- 0- 00	2
19	932483- 0- 00	2
20	944891- 0- 00	1
21	745800- 2- 00	1
22	944675- 0- 00	1
23	944894- 0- 00	1
24	924366- 2- 10	1
25	924354- 0- 00	1
26	724442- 2- 00	1
27	741634- 2- 00	2
28	704004- 0- 00	1

NOTA: Fig. N°1 Excepto Fig. N°: 3*,4*,5*,9*



ATACADOR
924059-4-00
VA1199820

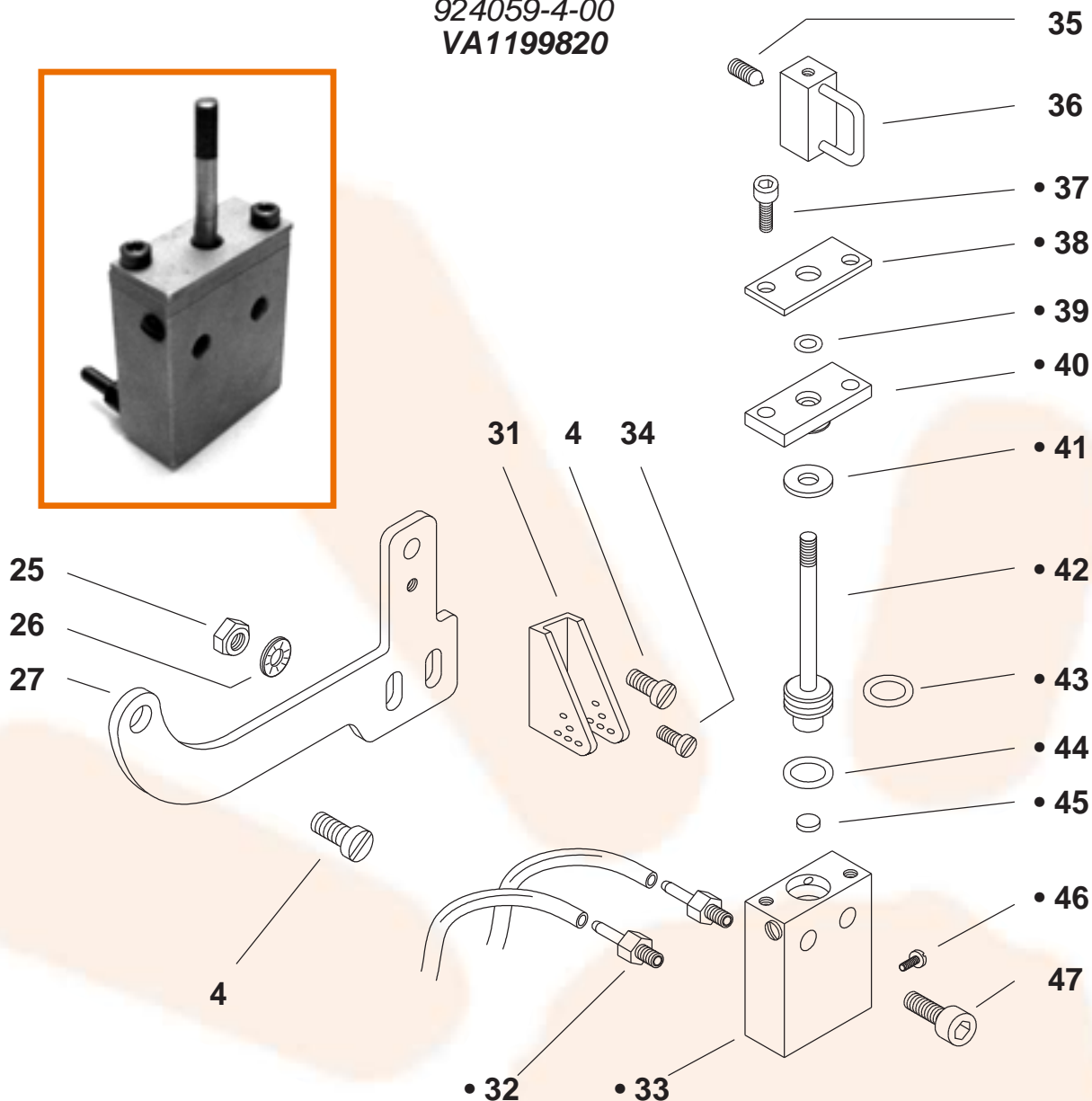

Fig. N°	Referencia	Cantidad
	924723- 5- 12 *	1
•	924059- 4- 00	1
4	741936- 2- 00	6
25	733505- 2- 00	2
26	703305- 0- 00	2
27	924727- 0- 20	1
31	924729- 0- 10	1
32	924701- 0- 11	2
33	924049- 0- 00	1
34	724411- 0- 00	1
35	745810- 5- 00	1
36	924980- 2- 10	1

Fig. N°	Referencia	Cantidad
37	722070- 2- 00	2
38	924047- 0- 00	1
39	701003- 0- 00	1
40	924048- 0- 00	1
41	924402- 0- 00	1
42	924046- 0- 00	1
43	701007- 0- 00	1
44	701004- 0- 00	1
45	924045- 0- 00	1
46	741303- 4- 00	3
47	722123- 2- 00	2

* Excepto Fig. 4



ATACADOR
932467-4-00
VA1199824

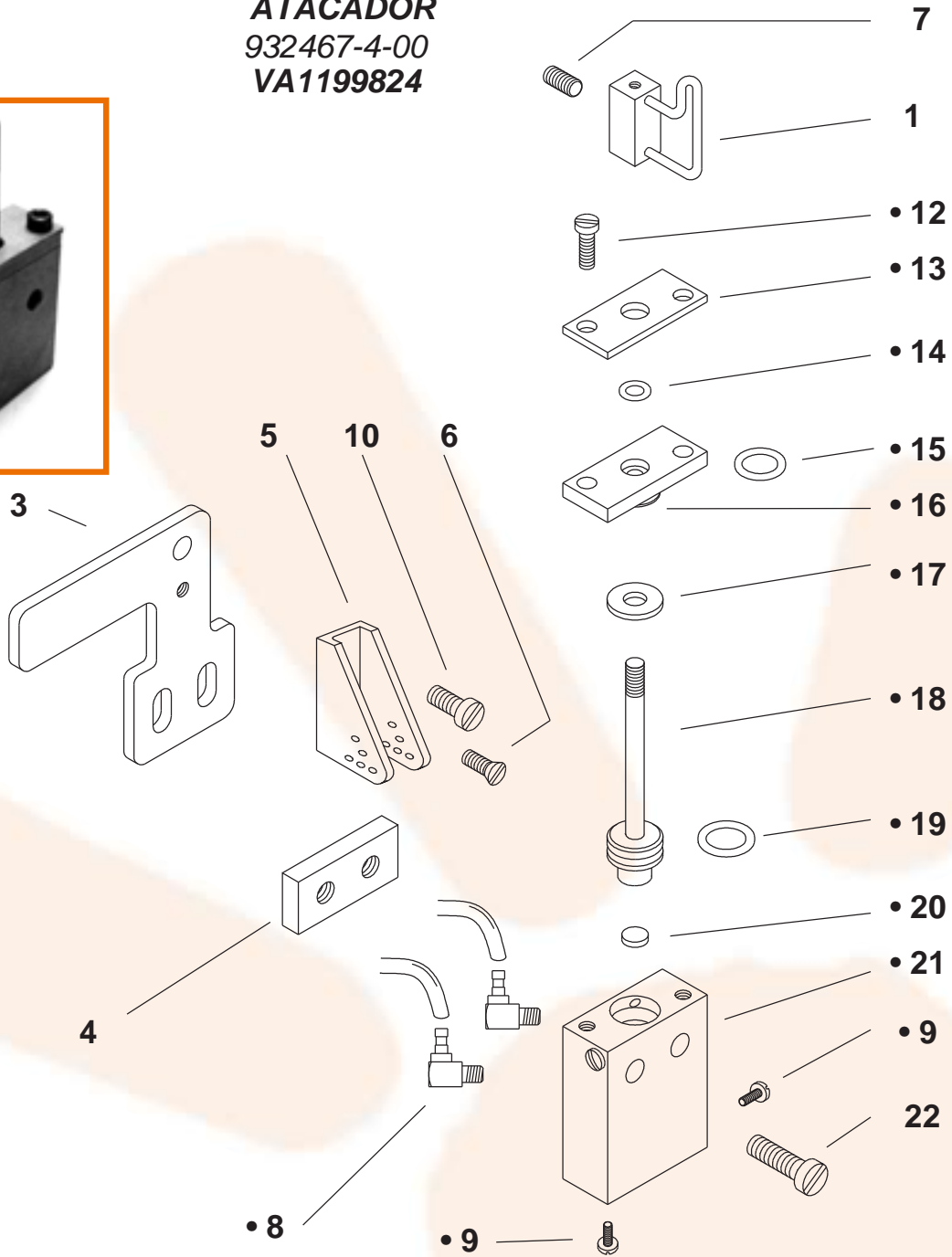

Fig. N°	Referencia	Cantidad
	932467- 4- 00 *	1
•	932244- 4- 00	1
3	315138- 0- 00	1
4	924730- 0- 20	1
5	924729- 0- 10	1
6	724411- 0- 00	1
7	745810- 5- 00	1
8	943765- 0- 01	2
9	741303- 4- 00	3
10	741936- 2- 00	1
11	924980- 2- 12	1

Fig. N°	Referencia	Cantidad
12	722070- 2- 00	2
13	924047- 0- 00	1
14	701003- 0- 00	1
15	701007- 0- 00	1
16	924048- 0- 00	1
17	924402- 0- 00	1
18	924046- 0- 00	1
19	701004- 0- 00	1
20	924045- 0- 00	1
21	924049- 0- 00	1
22	722123- 2- 00	2

* Excepto Fig. 10



ATACADOR
926668-5-00
VA1199812

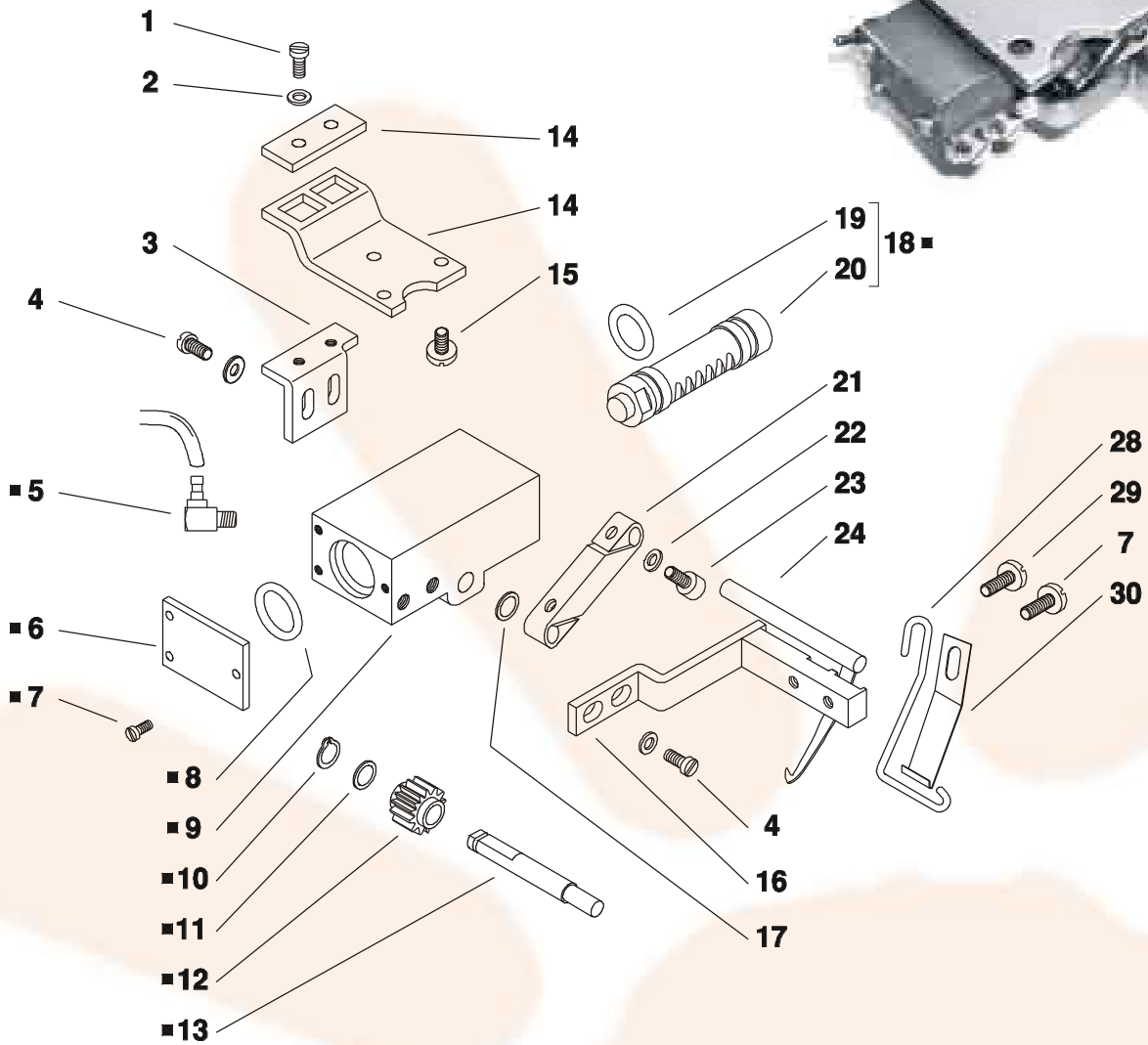

Fig. N°	Referencia	Cantidad
	926668-5-00 *	1
•	924961-4-11	1
1	721454-2-00	2
2	704210-4-00	2
3	926667-0-00	1
4	741936-2-00	6
5	924698-0-11	2
6	924972-0-00	2
7	741634-2-00	7
8	701017-0-00	2
9	924962-0-00	1
10	700005-0-00	1
11	703802-0-00	1
12	924965-0-11	1
13	924973-0-10	1

Fig. N°	Referencia	Cantidad
14	926676-0-10	1
15	740031-2-00	2
16	924976-2-00	1
17	704305-0-00	1
18	924964-4-01	1
19	701009-0-00	2
20	924963-0-01	1
21	924977-0-01	1
22	703003-0-00	2
23	722410-2-00	2
24	924970-2-00	1
28	924971-0-01	1
29	741654-0-00	1
30	924974-0-01	1

* Excepto Fig. 1, 2, 14, 15



DISPOSITIVO 924735-4-12

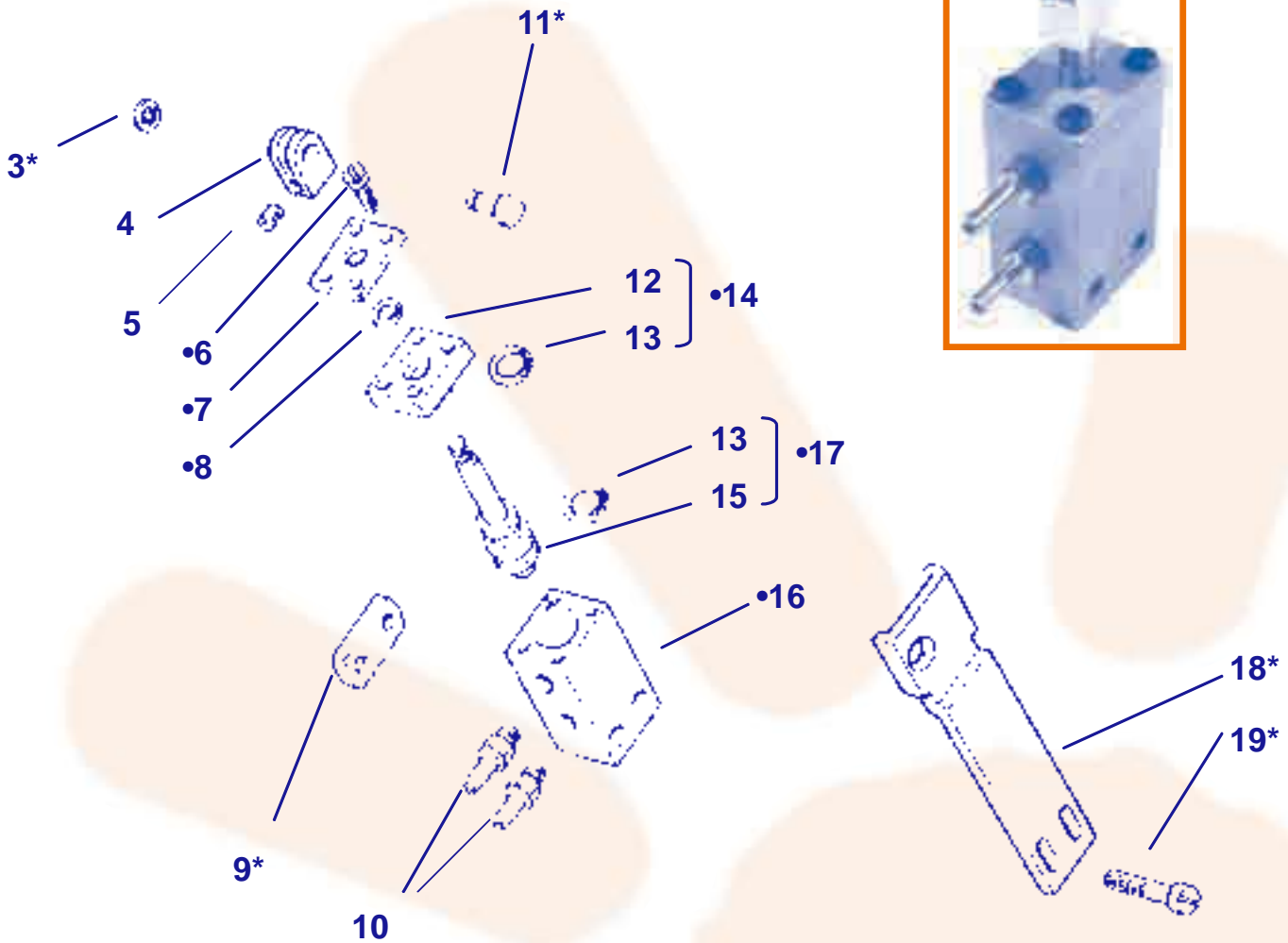

Fig. N°	Referencia	Cantidad
1	924735- 4- 12	1
•2	942883- 4- 00	1
3	700205- 0- 00	1
4	924739- 0- 10	1
5	745800- 2- 00	1
6	741495- 0- 00	4
7	924745- 0- 20	1
8	701104- 0- 00	1
9	924740- 0- 10	1
10	924701- 0- 11	2

Fig. N°	Referencia	Cantidad
11	202100- 0- 10	1
12	924736- 0- 21	1
13	701009- 0- 00	2
14	926669- 4- 01	1
15	924737- 0- 21	1
16	924734- 0- 20	1
17	924738- 4- 21	1
8	932465- 0- 00	1
19	721086- 2- 00	2

NOTA: Fig. N°1 Excepto Fig. Con *



ATACADOR
932462-4-00
VA1199821

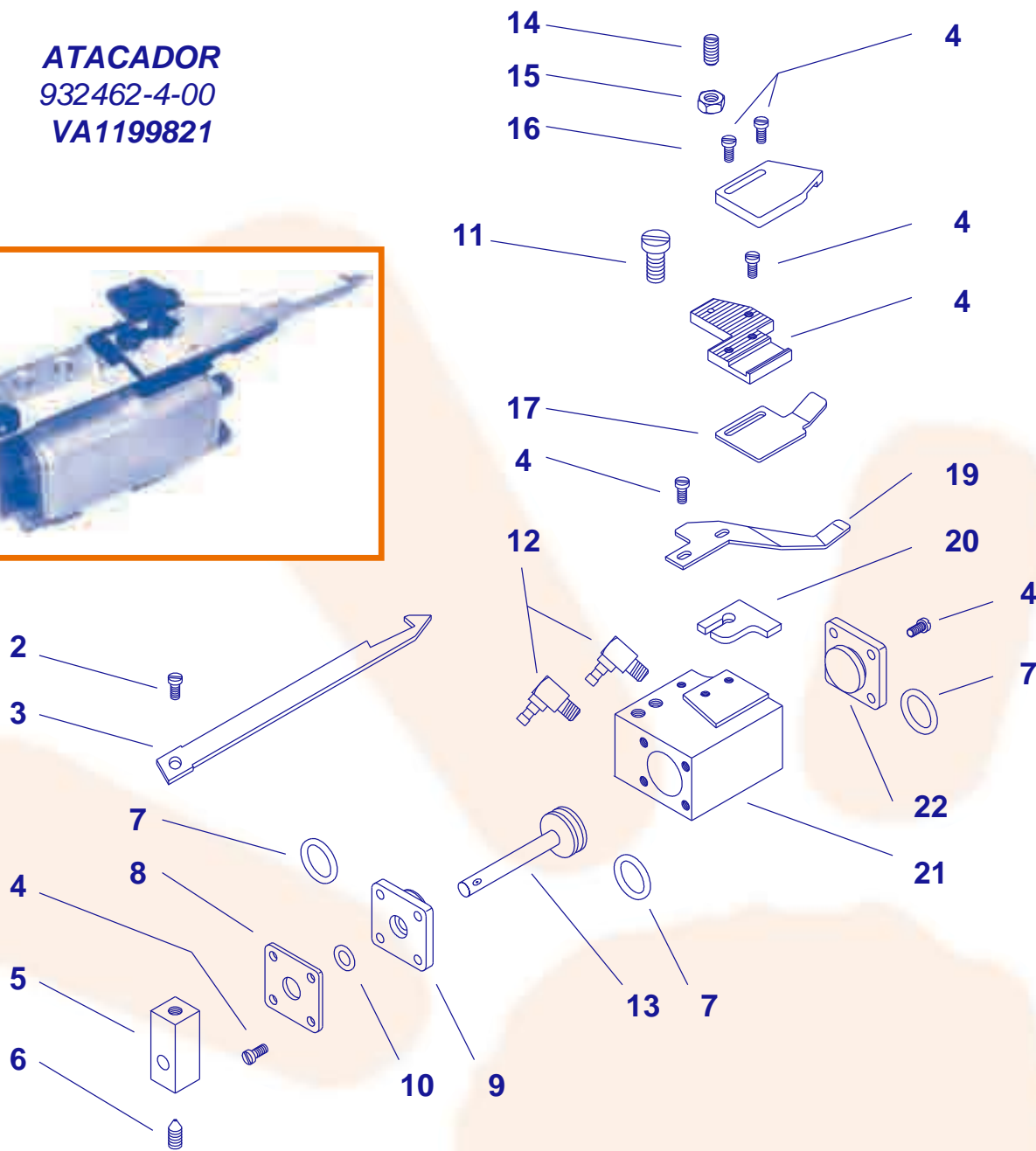

Fig. N°	Referencia	Cantidad
1	932462- 4- 00*	1
•2	741634- 2- 00	1
3	932453- 0- 00	1
4	722030- 2- 00	12
5	932457- 0- 00	1
6	730011- 2- 00	1
7	701009- 0- 00	3
8	924663- 0- 10	1
9	932489- 0- 00	1
10	701003- 0- 00	1
11	741956- 2- 00	2

Fig. N°	Referencia	Cantidad
12	943765- 0- 01	2
13	932458- 0- 00	1
14	727030- 2- 00	1
15	733502- 0- 00	1
16	932452- 0- 00	1
17	932455- 0- 00	1
18	932454- 0- 00	1
19	932456- 0- 00	1
20	932461- 0- 00	1
21	932460- 0- 00	1
22	924664- 0- 11	1

* Excepto Fig. 11



ATACADOR
946314-4-01
VA1199825

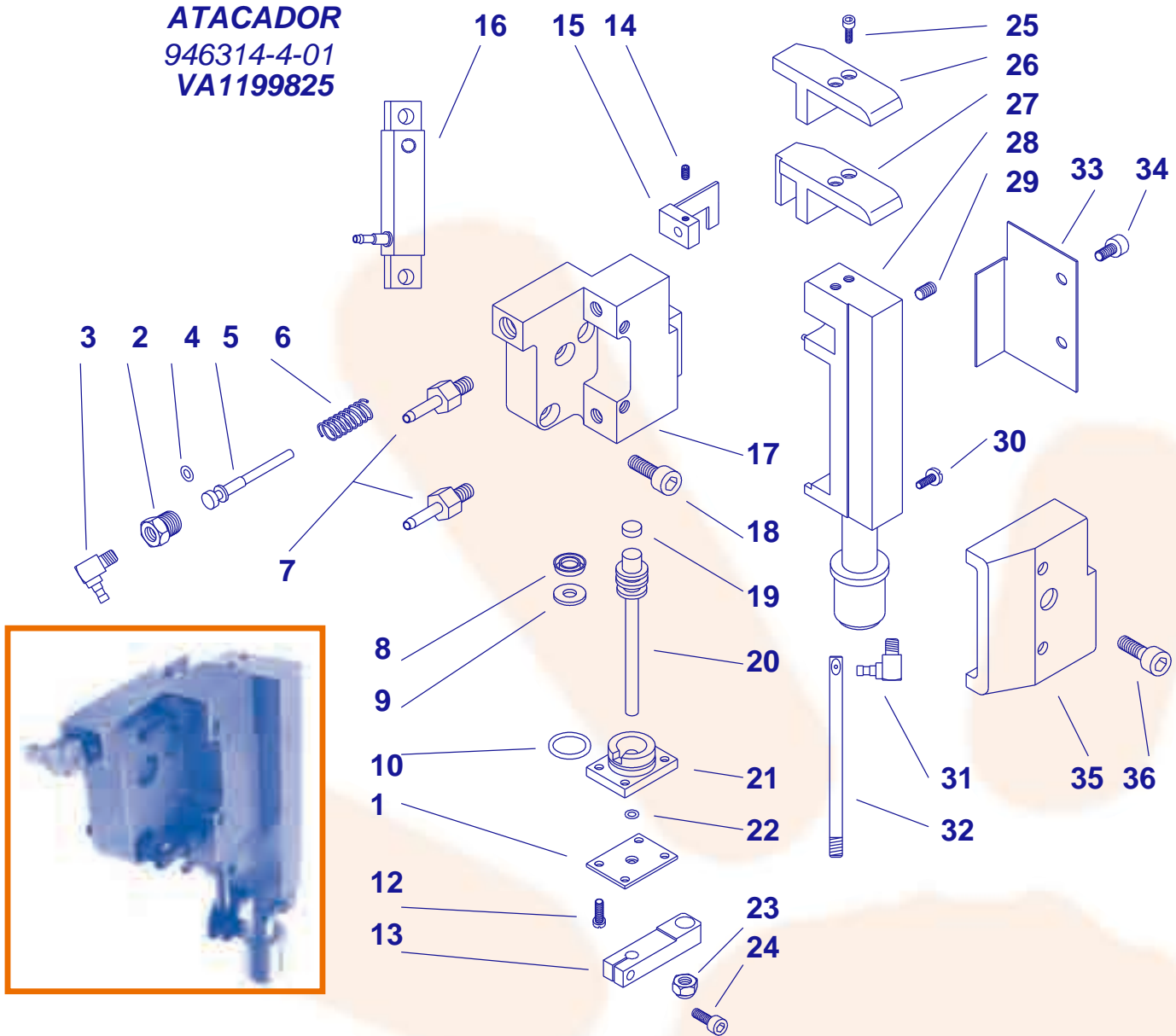

Fig. N°	Referencia	Cantidad
	946314- 4- 01*	1
2	946318- 0- 00	1
3	924457- 0- 00	1
4	701002- 0- 00	1
5	946324- 0- 00	1
6	100546- 0- 10	1
7	924488- 0- 01	2
8	946329- 0- 00	2
9	924731- 0- 20	1
10	701009- 0- 00	1
11	946326- 0- 00	1
12	722070- 2- 00	4
13	946327- 2- 00	1
14	745810- 2- 00	1
15	946325- 2- 01	1
16	946339- 2- 00	1
17	946321- 0- 01	1
18	722441- 2- 00	2

Fig. N°	Referencia	Cantidad
19	924045- 0- 00	1
20	946319- 0- 00	1
21	946323- 0- 00	1
22	701003- 0- 00	1
23	942787- 0- 00	1
24	722410- 2- 00	1
25	741542- 0- 00	1
26	946315- 0- 01	1
27	946357- 0- 00	1
28	946316- 2- 01	1
29	730022- 2- 00	1
30	741400- 0- 00	1
31	946362- 0- 00	1
32	946320- 0- 00	1
33	946338- 0- 01	1
34	932495- 0- 00	2
35	946332- 0- 00	1
36	203589- 0- 10	2

* Excepto Fig. 25, 26, 27, 35, 36



OWERLOCK 1 AGUJA 3 HILOS

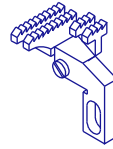
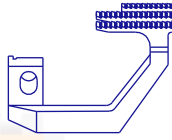
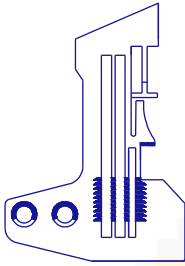

KG-131
SA12011

E-800
PA12011

H-445
DT12001

D-575
DT12002

P253E
PS12011

OWERLOCK 2 AGUJAS 4 HILOS

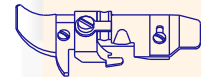
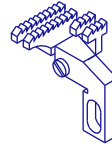
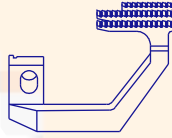
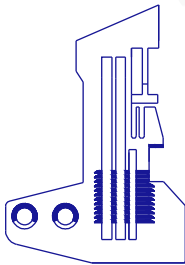

KG-142
SA12021

E-810
PA12021

H-445
DT12001

D-575
DT12002

P253/F374
PS12021

OWERLOCK 1 AGUJA

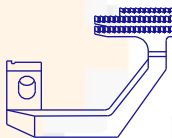
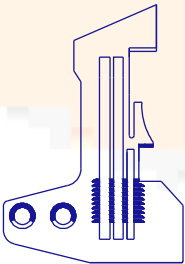

H-440
DT12013

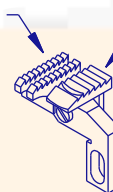

D-674
DT12028

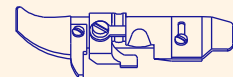

KG-131
SA12011

E-796
PA12013

H-445
DT12001

D-574
DT12005

P-230C
PS12015

OWERLOCK 1 AGUJA

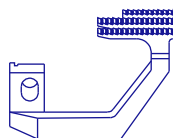
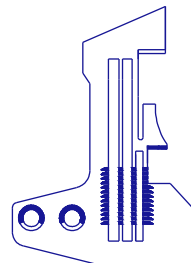

H-440
DT12013

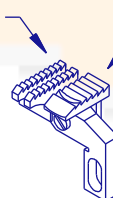

D-674
DT12028



KG-131
SA12011

E-797
PA12012

H-445
DT12001

D-574
DT12005

P-230C
PS12015



JUEGO OWERLOCK 1 AGUJA 3 HILOS

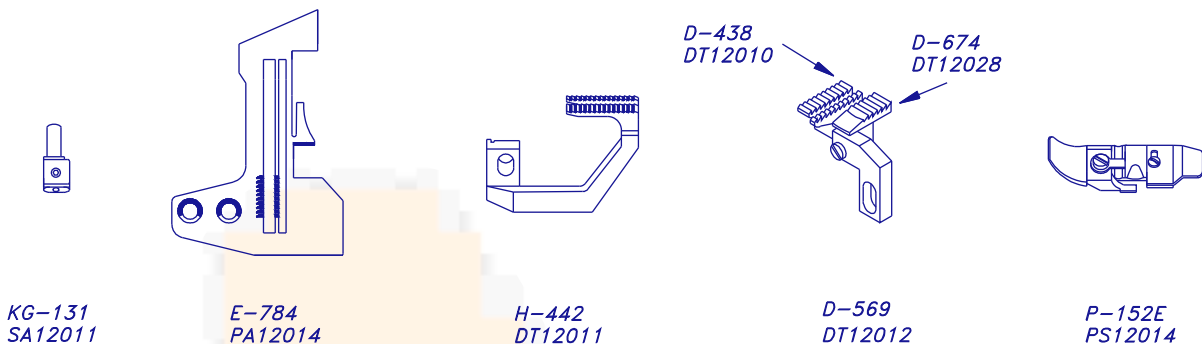

KG-131
SA12011

E-784
PA12014

H-442
DT12011

D-569
DT12012

P-152E
PS12014

JUEGO OWERLOCK 2 AGUJAS 4 HILOS

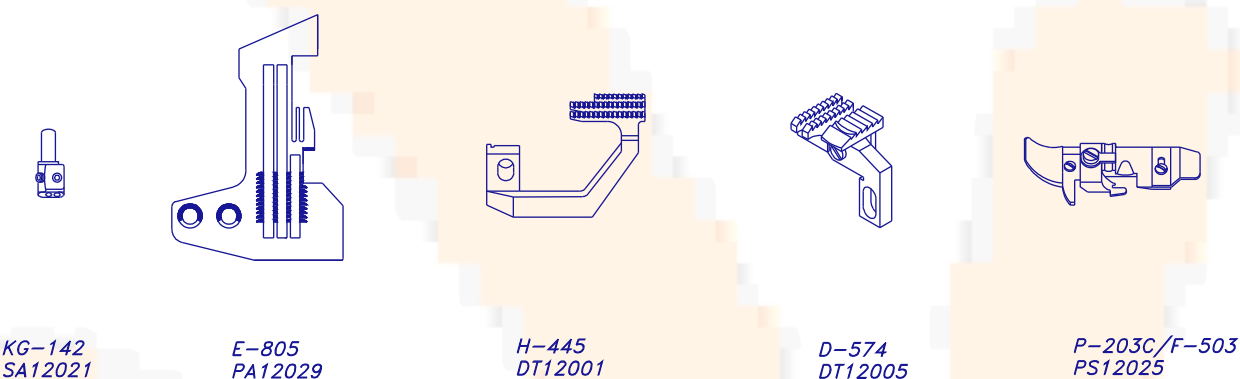

KG-142
SA12021

E-805
PA12029

H-445
DT12001

D-574
DT12005

P-203C/F-503
PS12025

JUEGO OWERLOCK 2 AGUJAS 4 HILOS

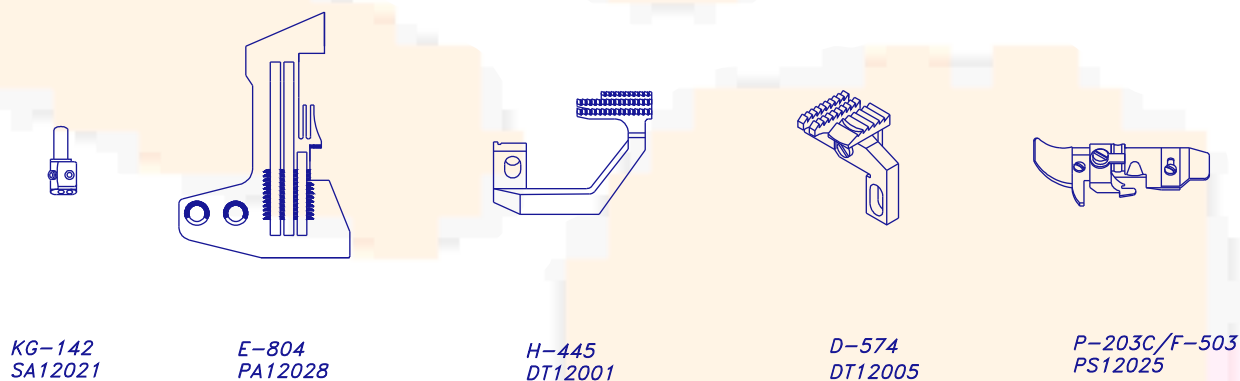

KG-142
SA12021

E-804
PA12028

H-445
DT12001

D-574
DT12005

P-203C/F-503
PS12025

JUEGO OWERLOCK 1 AGUJA 3 HILOS

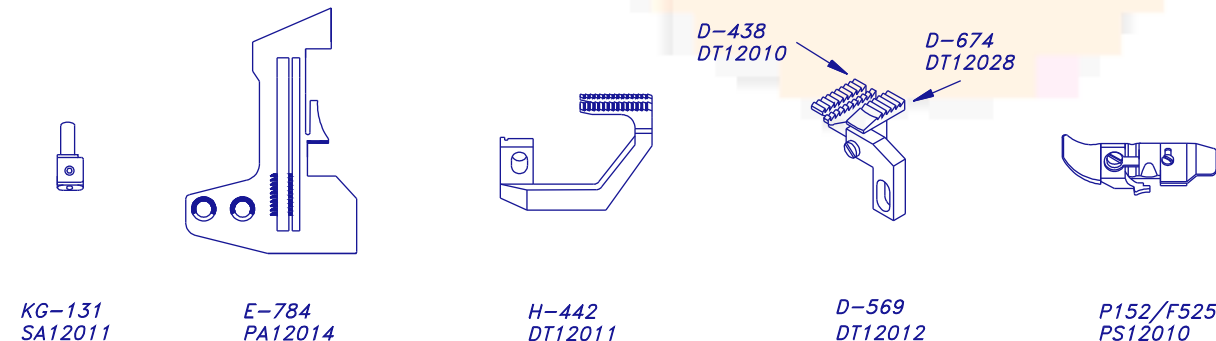

KG-131
SA12011

E-784
PA12014

H-442
DT12011

D-569
DT12012

P152/F525
PS12010



OWERLOCK 2 AGUJAS 5 HILOS



KG-153
SA12023

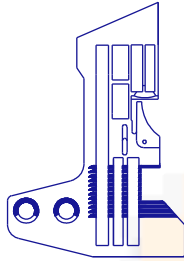

E-980
PA12022

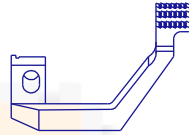

H-957
DT12024

D-008
DT12021

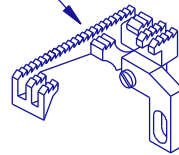

D-002
DT12022

D-502
DT12025

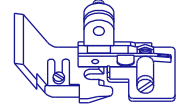

P-508
PS12022

OWERLOCK 2 AGUJAS 5 HILOS



KG-155
SA12022

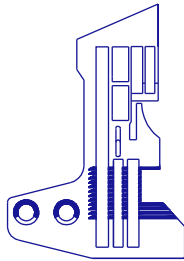

E-986
PA120210

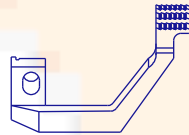

H-957
DT12024

D-956
DT12023

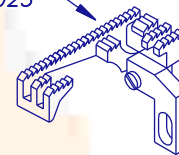

D-003
DT120211

D-502
DT12025

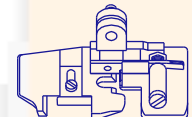

P-509
PS12027

JUEGO OWERLOCK 2 AGUJAS 5 HILOS



KG-155
SA12022

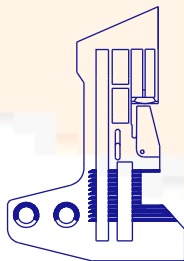

E-853
PA12026

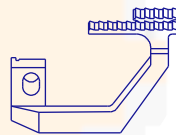

H-495
DT12029

D-490
DT12026

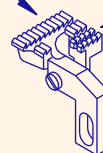

D-582
DT120210

D-502
DT12025

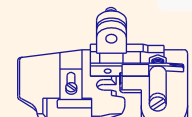

P-955
PS12026

JUEGO OWERLOCK 2 AGUJAS 5 HILOS



KG-155
SA12022

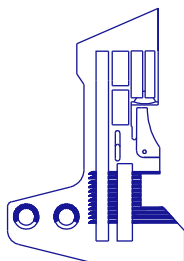

E-854
PA12025

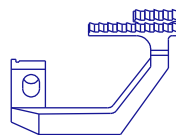

H-495
DT12029

D-490
DT12026

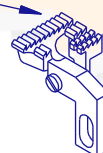

D-582
DT120210

D-502
DT12025

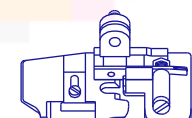

P-955
PS12026



OWERLOCK 1 AGUJA 5 HILOS

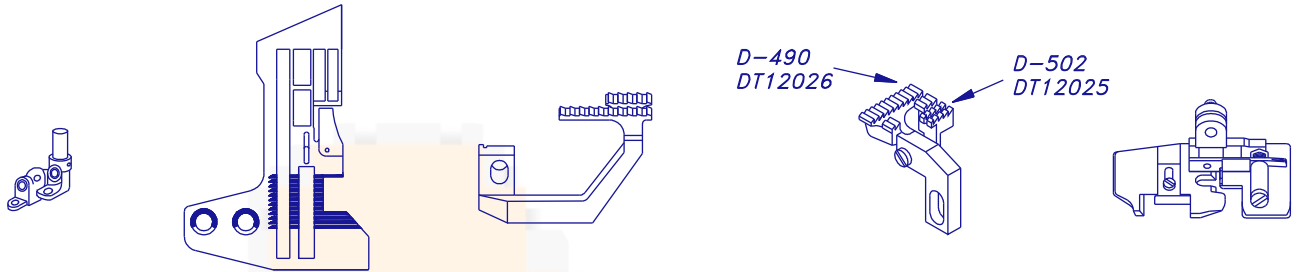

KG-155
SA12022

E-851
PA12023

H-495
DT12029

D-582
DT120210

P-502
PS12013

OWERLOCK 2 AGUJAS 5 HILOS

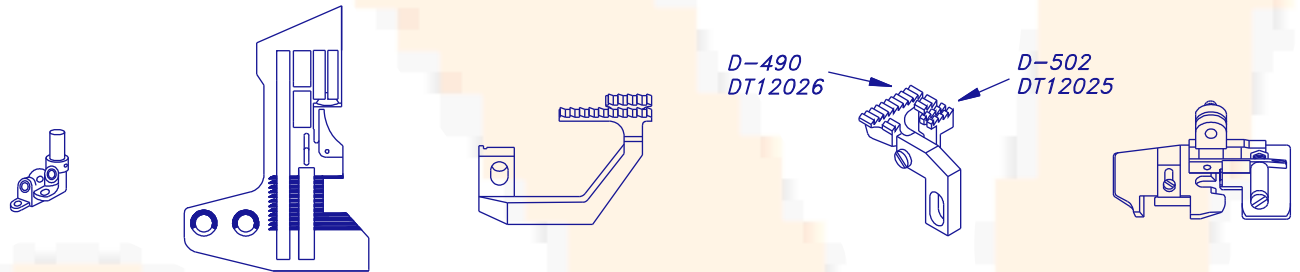

KG-153
SA12023

E-845
PA12027

H-495
DT12029

D-582
DT120210

P-501
PS12028

OWERLOCK 2 AGUJAS 5 HILOS

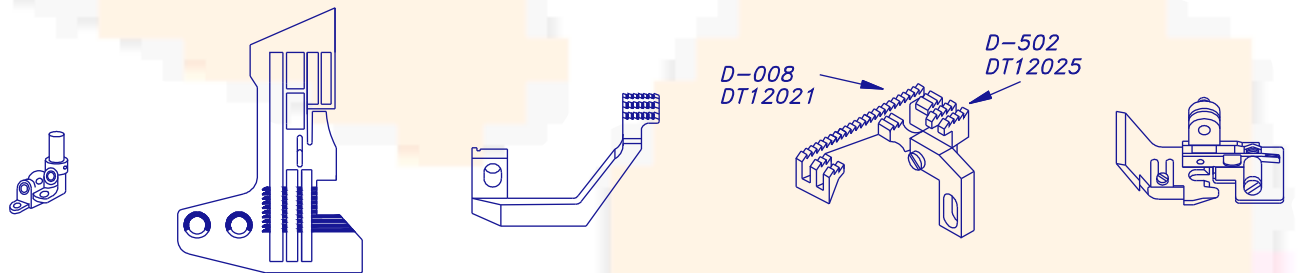

KG-153
SA12023

E-982
PA12024

H-957
DT12024

D-002
DT12022

P-508
PS12022



F007-W122

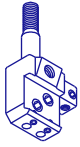

M4240
SA12024

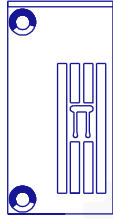

E1524
PA12032

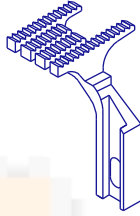

D1206
DT12015

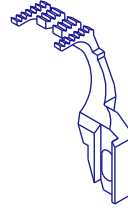

H1258
DT12016

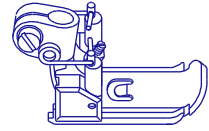

P0014
PS12018



M4248
SA12025

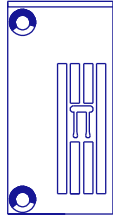

E1525
PA12033

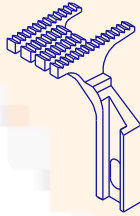

D1206
DT12015

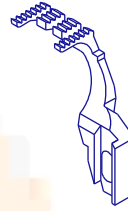

H1258
DT12016

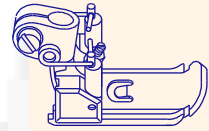

P0015
PS12017



M4356
SA12026

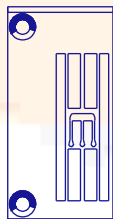

E1826
PA12031

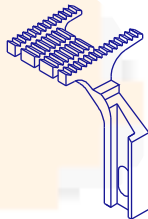

D1207
DT12014

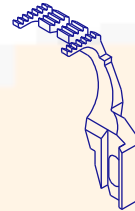

H1259
DT12017

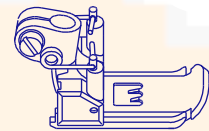

P0016
PS12019

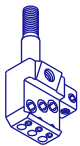

M4364
SA12027

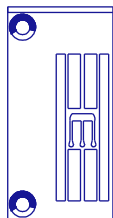

E1827
PA12030

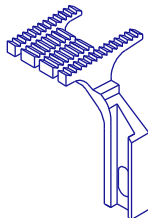

D1207
DT12014

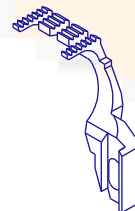

H1259
DT12017

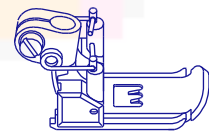

P0017
PS12020



F007-U122

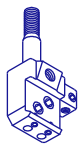

M4240
SA12024

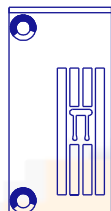

E1524
PA12032

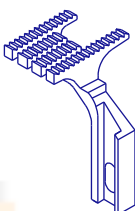

D1206
DT12015

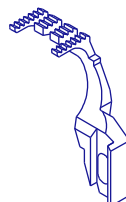

H1258
DT12016

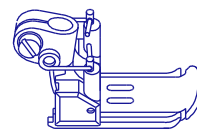

P0214
PS12032

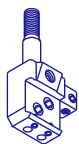

M4248
SA12025

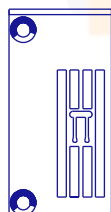

E1525
PA12033

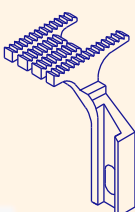

D1206
DT12015

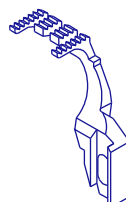

H1258
DT12016

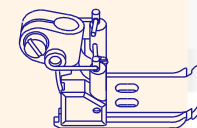

P0215
PS12033



M4356
SA12026

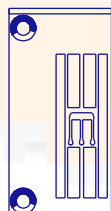

E1826
PA12031

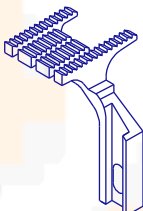

D1207
DT12014

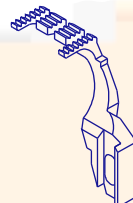

H1259
DT12017

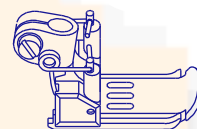

P0316
PS12034

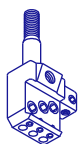

M4364
SA12027

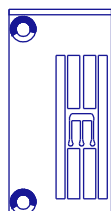

E1827
PA12030

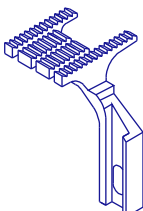

D1207
DT12014

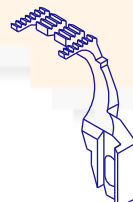

H1259
DT12017



P0317
PS12035



F007-U122/FP

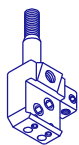

M4232
SA12028

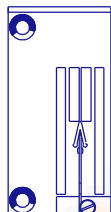

E1623
PA12034

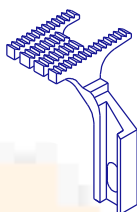

D1206
DT12015

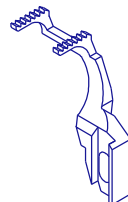

H1257
DT12030

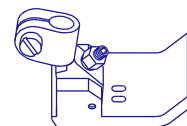

P4011
PS12036

F007-W123

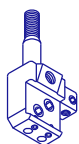

M4240
SA12024

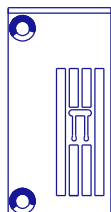

E1534
PA12035

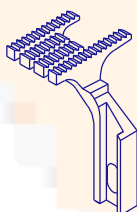

D1206
DT12015

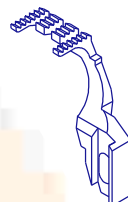

H1258
DT12016

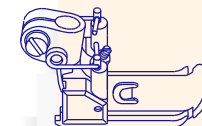

P0014
PS12018



M4248
SA12025

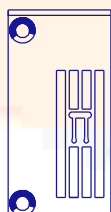

E1535
PA12036

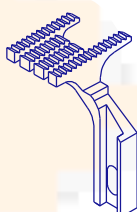

D1206
DT12015

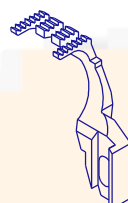

H1258
DT12016

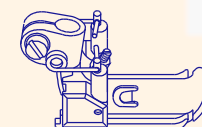

P0015
PS12017

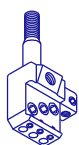

M4356
SA12026

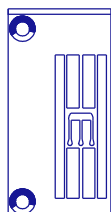

E1836
PA12037

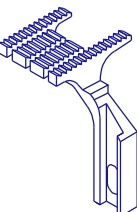

D1207
DT12014

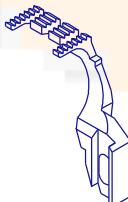

H1259
DT12017

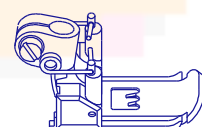

P0016
PS12019

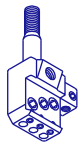

M4364
SA12027

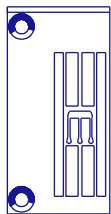

E1837
PA12038

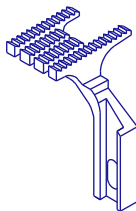

D1207
DT12014

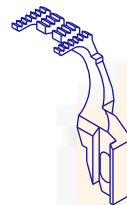

H1259
DT12017

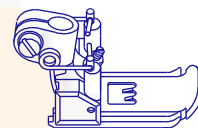

P0017
PS12020

F007-W222/FQ

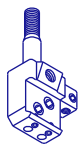

M4240
SA12024

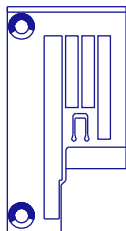

E3024
PA12039

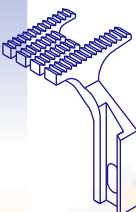

D1215
DT12031



H1261
DT12033

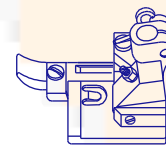

P1814
PS12053

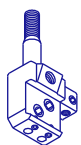

M4248
SA12025

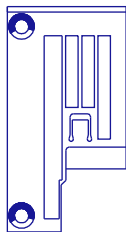

E3025
PA12040

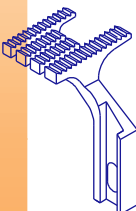

D1215
DT12031



H1261
DT12033

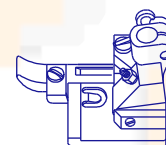

P1815
PS12054

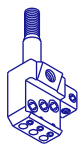

M4356
SA12026

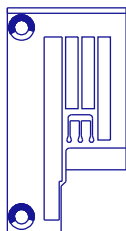

E3326
PA12041

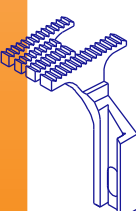

D1216
DT12032

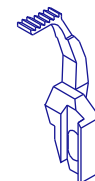

H1262
DT12034

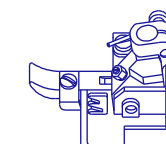

P2116
PS12055

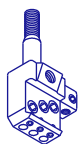

M4364
SA12027

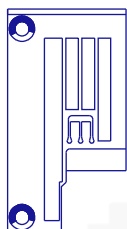

E3327
PA12042

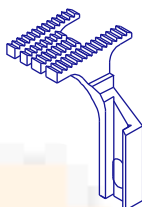

D1216
DT12032

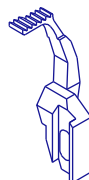

H1262
DT12034

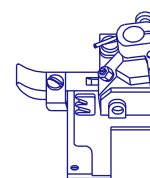

P2117
PS12056

F007-U222/FQ

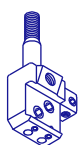

M4240
SA12024

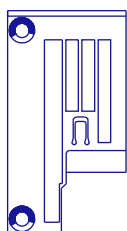

E3024
PA12039

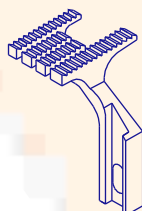

D1215
DT12031



H1261
DT12033

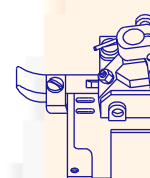

P2314
PS12057



M4248
SA12025

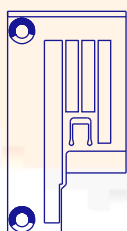

E3025
PA12040

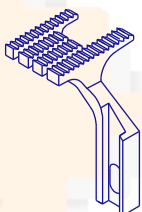

D1215
DT12031



H1261
DT12033

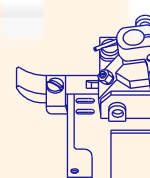

P2315
PS12058



M4356
SA12026

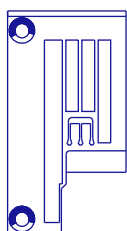

E3326
PA12041

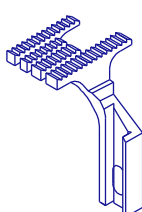

D1216
DT12032



H1262
DT12034

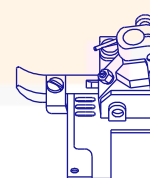

P2616
PS12059

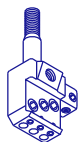

M4364
SA12027

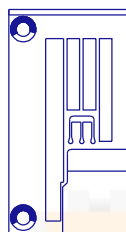

E3327
PA12042

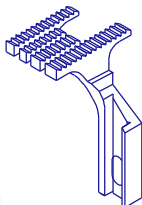

D1216
DT12032



H1262
DT12034

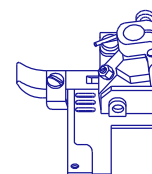

P2617
PS12060

F007-W223

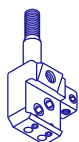

M4240
SA12024

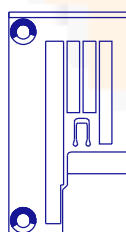

E3034
PA12043

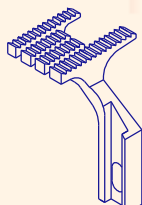

D1215
DT12031



H1261
DT12033

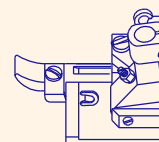

P1814
PS12053



M4356
SA12026

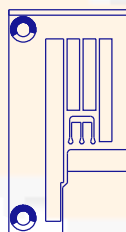

E3336
PA12044

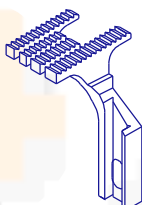

D1216
DT12032



H1262
DT12034

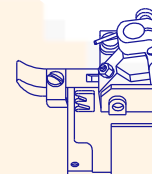

P2116
PS12055

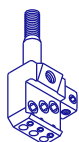

M4364
SA12027

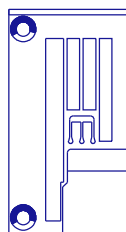

E3337
PA12045

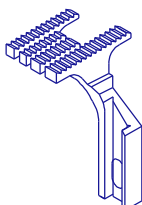

D1216
DT12032



H1262
DT12034

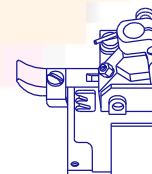

P2117
PS12056



F007-W522/FE(FFC)/FR



M4240
SA12024

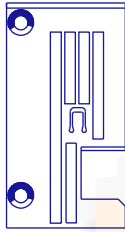

E6024
PA12046

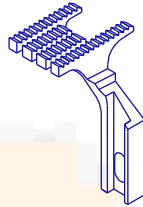

D2221
DT12035



H2267
DT12039

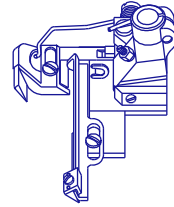

P2814
PS12037



M4248
SA12025

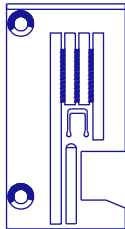

E6025
PA12047

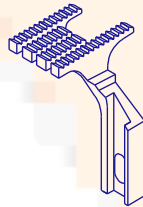

D2221
DT12035



H2267
DT12039

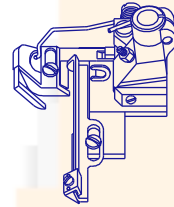

P2815
PS12038



M4356
SA12026

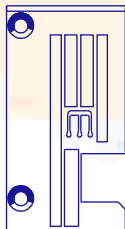

E6326
PA12048

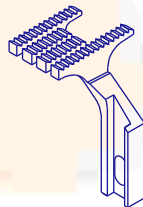

D2222
DT12036



H2268
DT12040

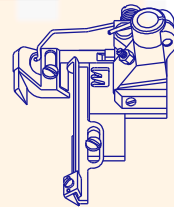

P3116
PS12039



M4364
SA12027

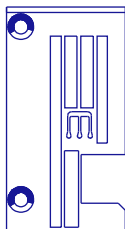

E6327
PA12049

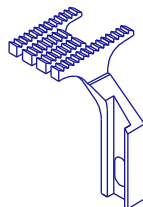

D2222
DT12036



H2268
DT12040

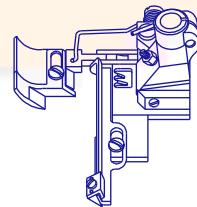

P3117
PS12040



F007-U522/FE(FFC)/FR

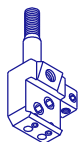

M4240
SA12024

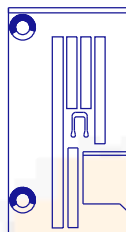

E6024
PA12046

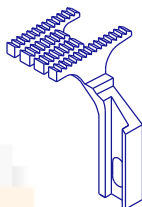

D2221
DT12035



H2267
DT12039

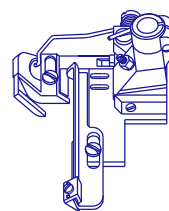

P3314
PS12041

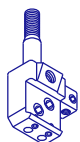

M4248
SA12025

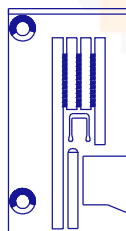

E6025
PA12047

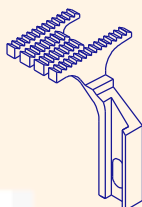

D2221
DT12035



H2267
DT12039

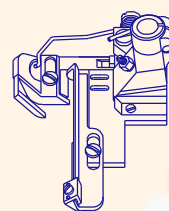

P3315
PS12042



M4356
SA12026

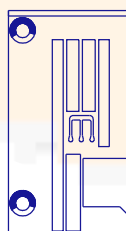

E6326
PA12048

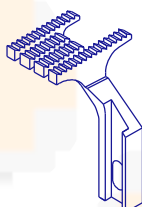

D2222
DT12036



H2268
DT12040

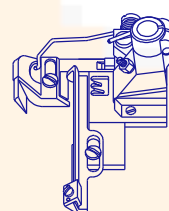

P3616
PS12043

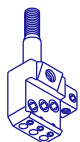

M4364
SA12027

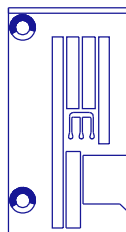

E6327
PA12049

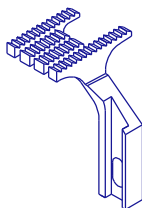

D2222
DT12036



H2268
DT12040

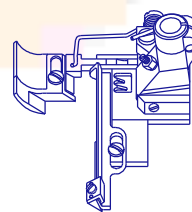

P3617
PS12044



F007-W522/FE/FFC

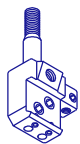

M4240
SA12024

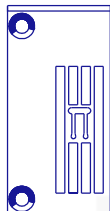

E1524
PA12032

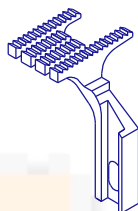

D1206
DT12015

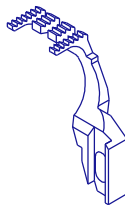

H1258
DT12016

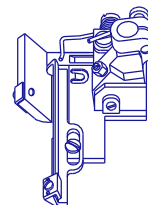

P2914
PS12045



M4248
SA12025

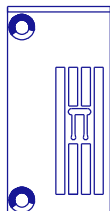

E1525
PA12033

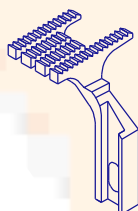

D1206
DT12015



H1258
DT12016

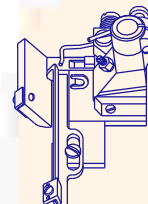

P2915
PS12046



M4356
SA12026

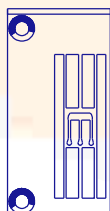

E1826
PA12031

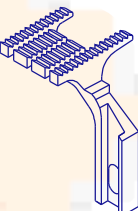

D1207
DT12014

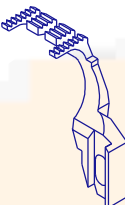

H1259
DT12017

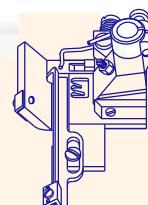

P3216
PS12047

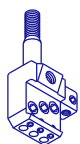

M4364
SA12027

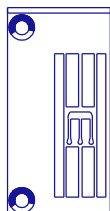

E1827
PA12030

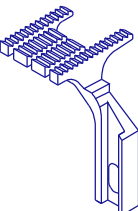

D1207
DT12014

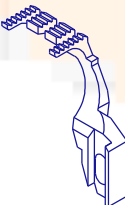

H1259
DT12017

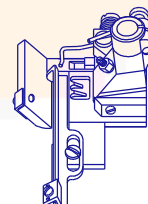

P3217
PS12048



F007-U522/FE/FFC

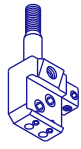

M4240
SA12024

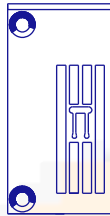

E1524
PA12032

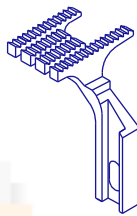

D1206
DT12015

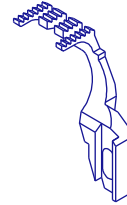

H1258
DT12016

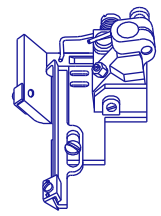

P3414
PS12049

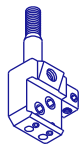

M4248
SA12025

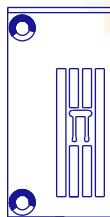

E1525
PA12033

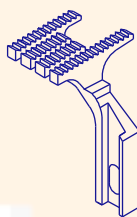

D1206
DT12015

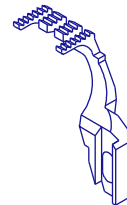

H1258
DT12016

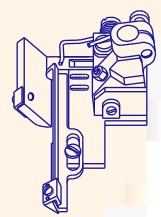

P3415
PS12050



M4356
SA12026

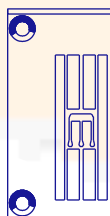

E1826
PA12031

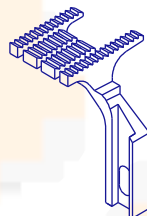

D1207
DT12014

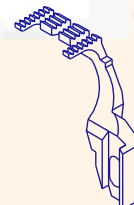

H1259
DT12017

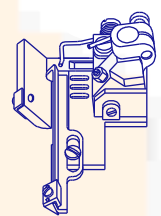

P3716
PS12051

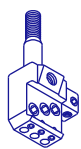

M4364
SA12027

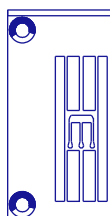

E1827
PA12030

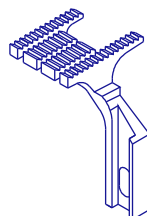

D1207
DT12014

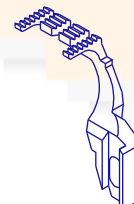

H1259
DT12017

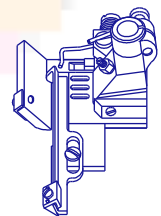

P3717
PS12052



F007-U612/FBQ

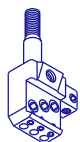

M4356
SA12026

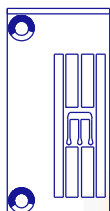

E1826
PA12031
E4001
PA12050

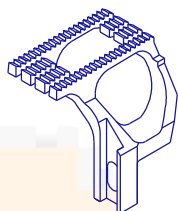

D5001
DT12037

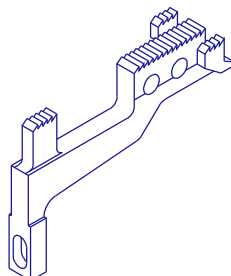

H5001
DT12038

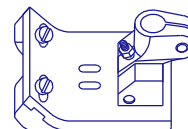

P4000
PS12061
P4002
PS12062

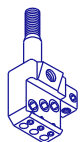

M4364
SA12027

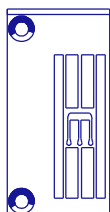

E1827
PA12030
E4001
PA12050

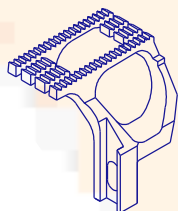

D5001
DT12037

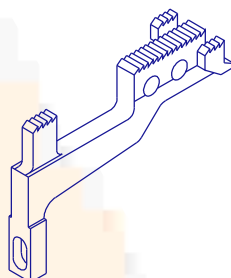

H5001
DT12038

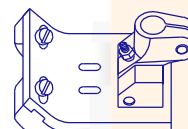

P4001
PS12063
P4002
PS12062

F007-U612/FBP

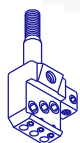

M4356
SA12026

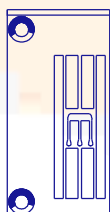

E1826
PA12031

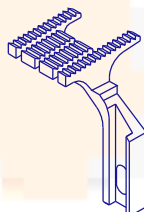

D1207
DT12014

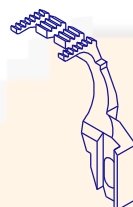

H1259
DT12017

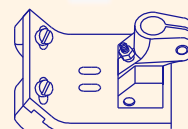

P4000
PS12061

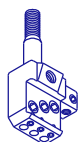

M4364
SA12027

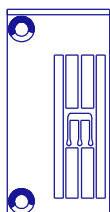

E1827
PA12030

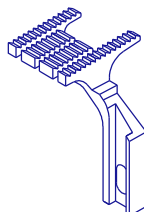

D1207
DT12014

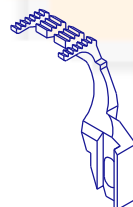

H1259
DT12017

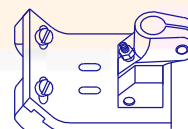

P4001
PS12063

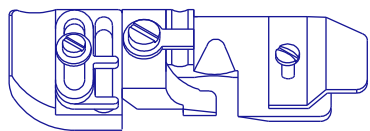

P101-3
PS12029

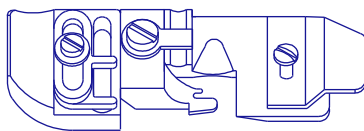

P101-4
PS12064

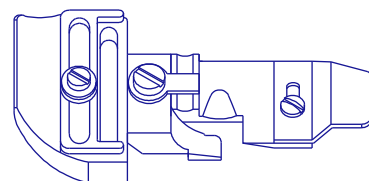

P102-3
PS12030

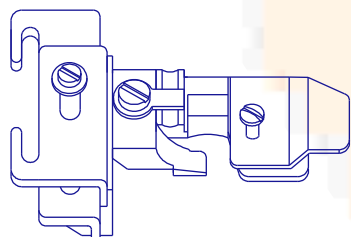

P103-3
PS12031

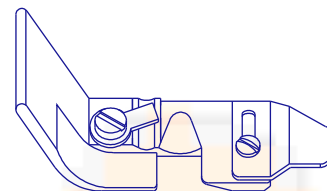

P-136
PS12023

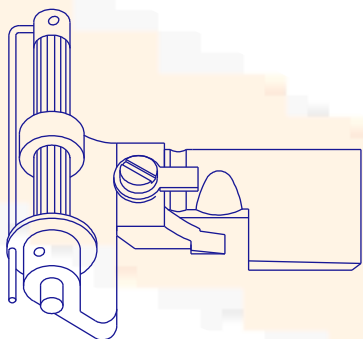

PS12012/2 - Prensateles 1 aguja rodillo 10 mm.

PS12012 - Prensateles 1 aguja rodillo 30 mm.

PS12012/1 - Prensateles 1 aguja rodillo 45 mm.

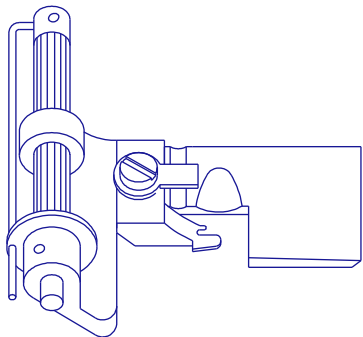

PS12016/2 - Prensateles 2 agujas rodillo 10 mm.

PS12016 - Prensateles 2 agujas rodillo 30 mm.

PS12016/1 - Prensateles 2 agujas rodillo 45 mm.

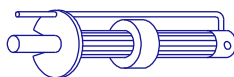

VA40410124 → 10 mm

VA40410121 → 30 mm

VA40410122 → 45 mm

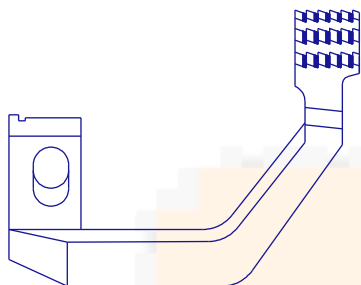

H-959
DT12004

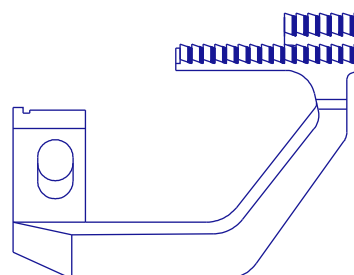

H-494
DT12027

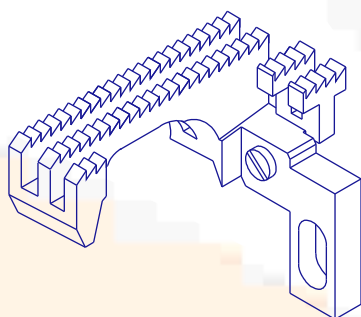

D-996
DT12003



D-095
DT12006

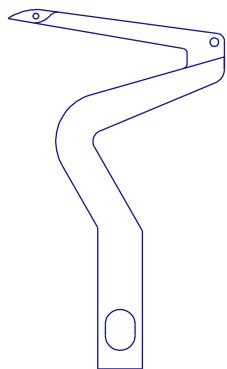

KL-25
AN12013
KL-35A (LANA)
AN12016

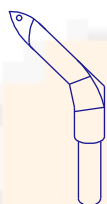

LP-26
AN12014

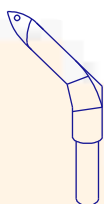

LP-36
AN12021

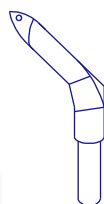

LP-38
AN12022

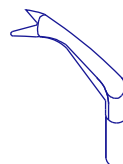

LP-21
AN12018



LP-22
AN12015

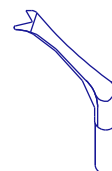

LP-23
AN12012

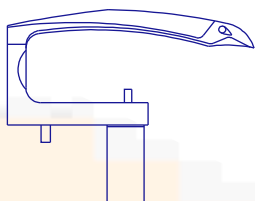

ME28
AN12017



KR-35
CH12003

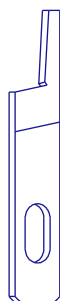

KR-23CT
CH12002



KR-23
CH12001

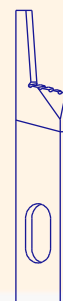

KR-23A
CH12005



KS-24
CH12004

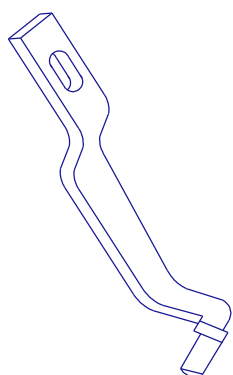

KG-471
VA1200809

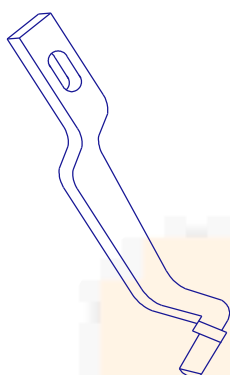

KG-472
VA1202814



KG-59
VA1200802

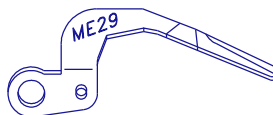

ME29
VA1200132

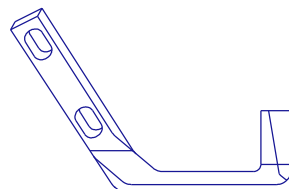

KG-37
VA1200131

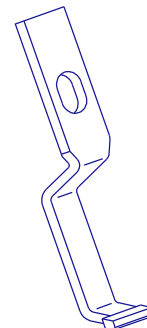

KG-35
VA1200130

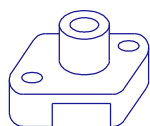

KQ-37-2
VA1200051

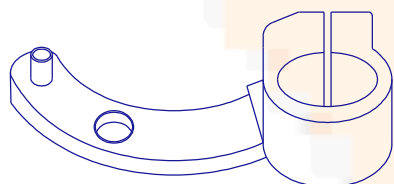

KQ-37C
VA1200807



KQ-37-1
VA1200052

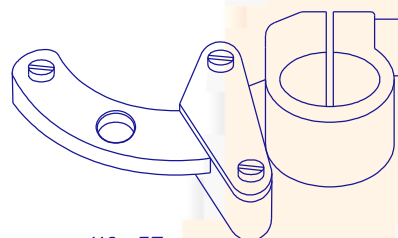

KQ-37
VA12008036

TENSOR OWERLOK SIRUBA

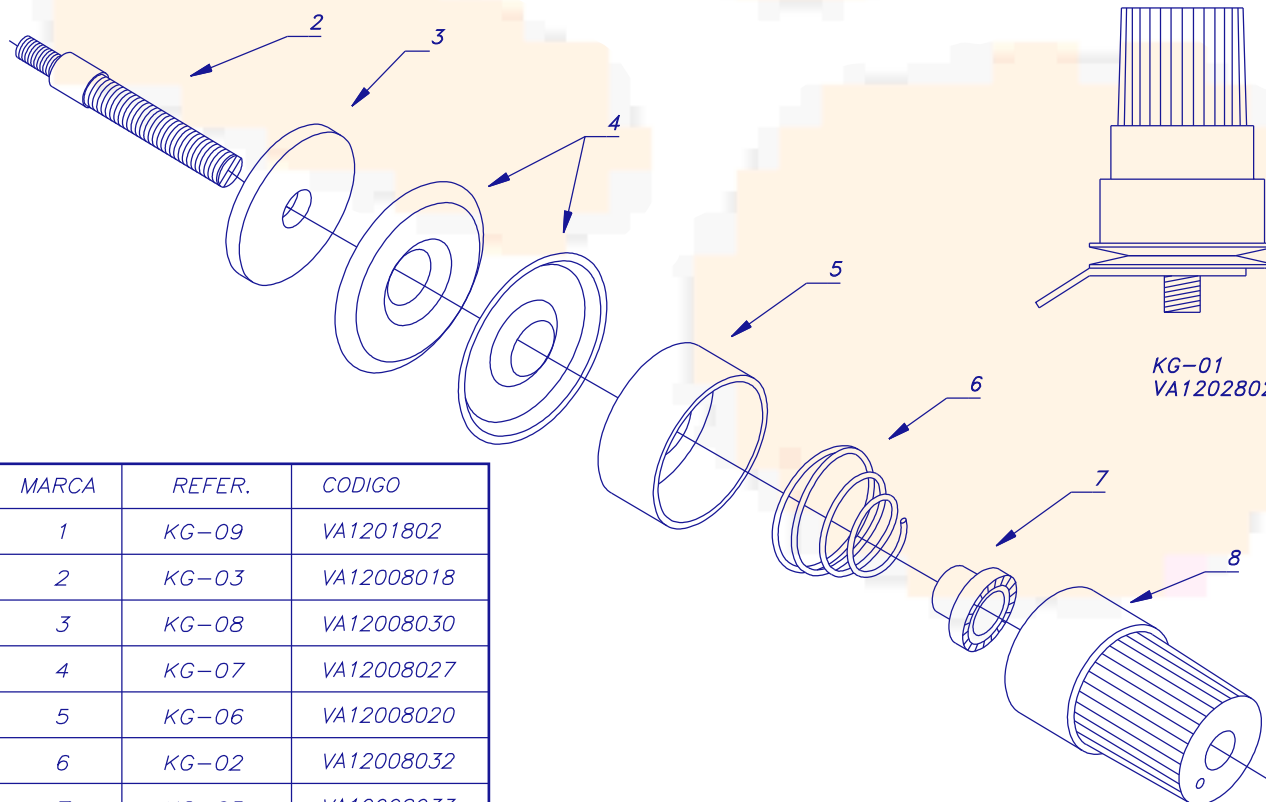

MARCA	REFER.	CODIGO
1	KG-09	VA1201802
2	KG-03	VA12008018
3	KG-08	VA12008030
4	KG-07	VA12008027
5	KG-06	VA12008020
6	KG-02	VA12008032
7	KG-05	VA12008033
8	KG-04	VA12008019

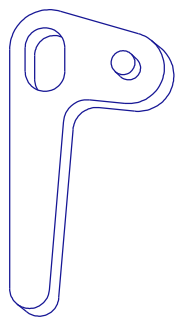

KS-05
VA12008022

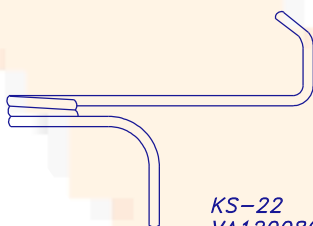

KS-22
VA12008021

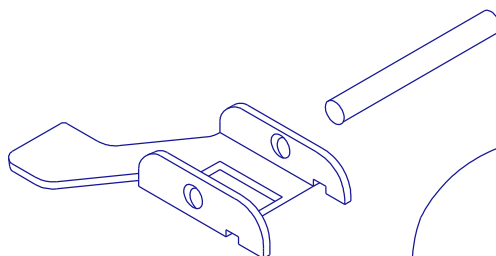

KS-29
VA12008023

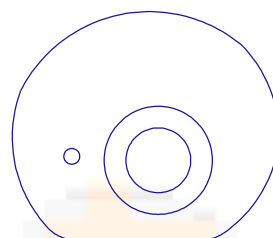

KN-18
VA1201801

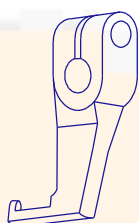

KS-56
VA1200122



SK-230
TN120012



KS-54
VA1200123



KS-64
VA1200125



KS-62
VA1200121



KS-58
VA1200124

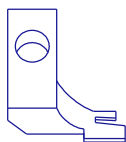

F-374
VA1202121

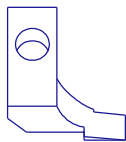

F-371
VA1201121

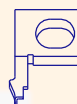

F-525
VA1201122

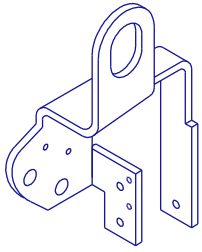

KG-54D
VA1202811

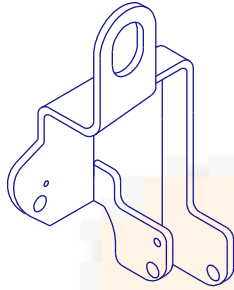

KG-54
VA12008017

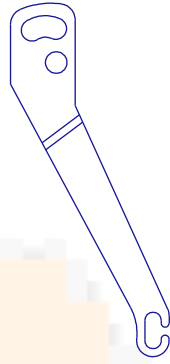

KG-60D
VA1202810

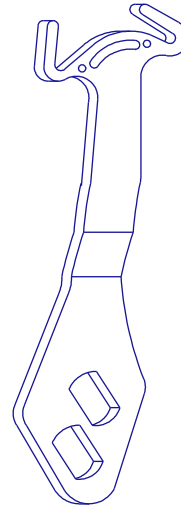

KG-60
VA1200054

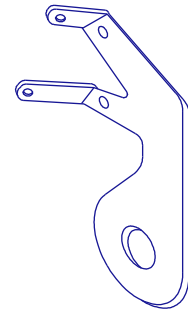

KJ-68
VA12008016

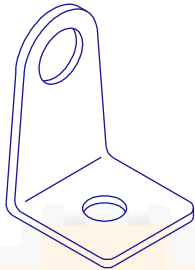

KC-07
VA12008025



KL-43
VA1202809

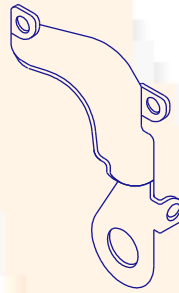

KL-46
VA1202818

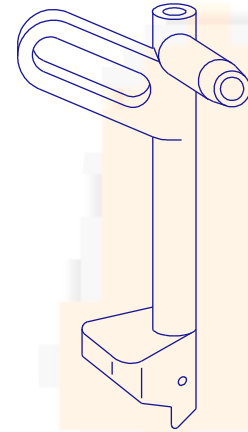

KU-14
VA12008014



KG-17
VA1200804



KG-18
VA1200803



KU-25
VA12008015



KG-21
VA1200806

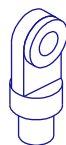

KL-36
VA12002813



KG-19
VA1200805

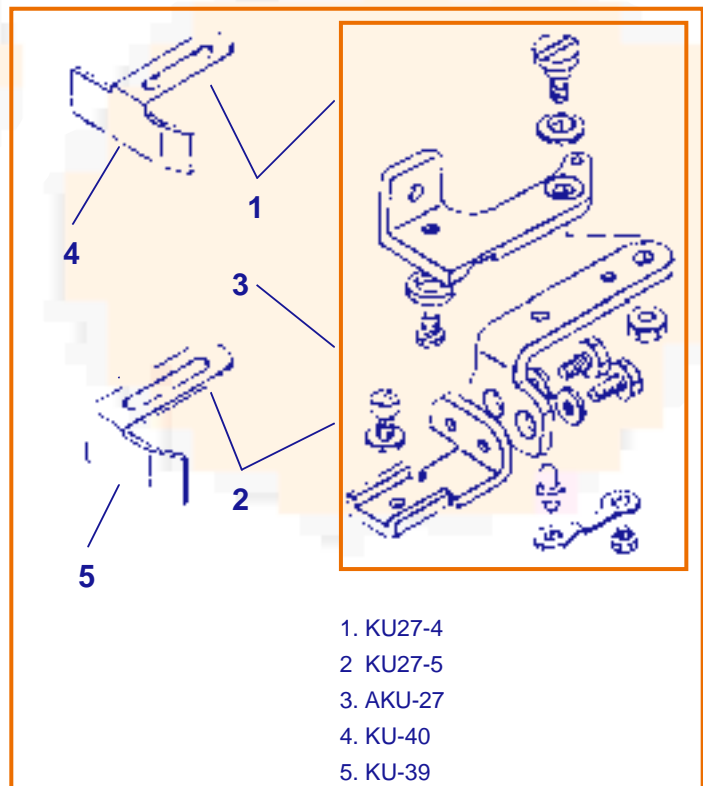

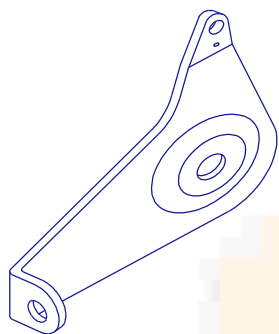

KG-10
VA1202803

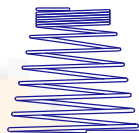

KJ-51
VA120283

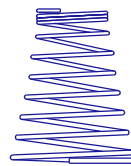

KL-30
VA1200129



KS-03
VA1202822

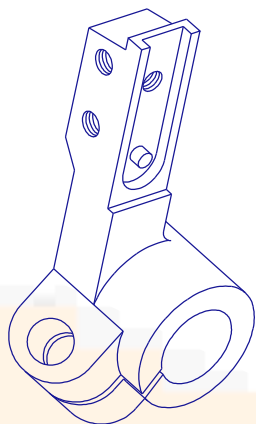

KL-23E
VA1200231

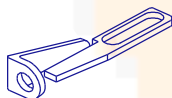

KN-22
VA12008034



KR-36
VA1202823

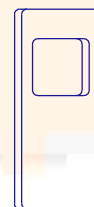

KQ-49
VA1200053

PROTECTOR OJOS

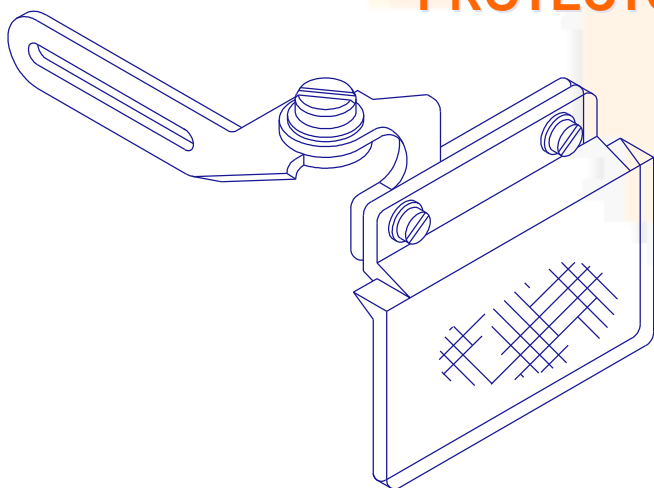

VA1202813

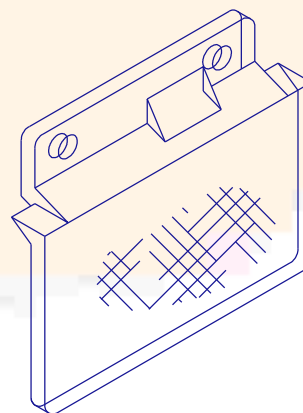

KC-19
KC-19F
VA1202801

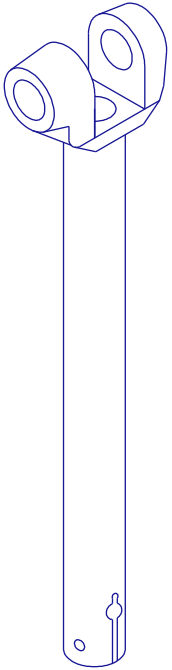

KJ-26
VA1202807

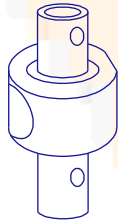

KJ-30
VA1202808

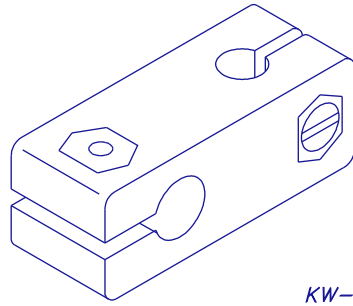

KW-20
VA12008029

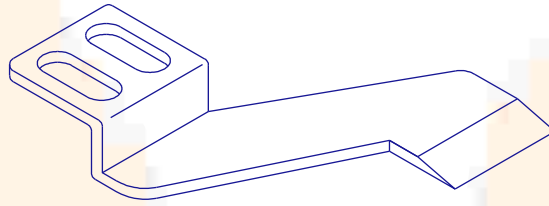

VA1202812

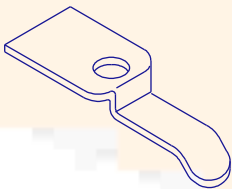

KC-36
VA1202805



KB-11
VA12008024



KR-22
VA12008010

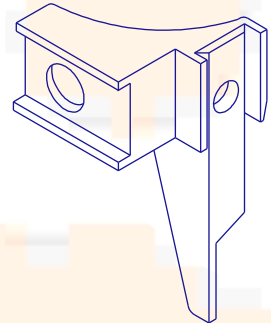

KR-19
VA1202815

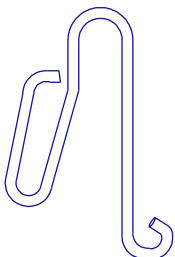

KB-12
VA12008028



KD-05
VA1202820

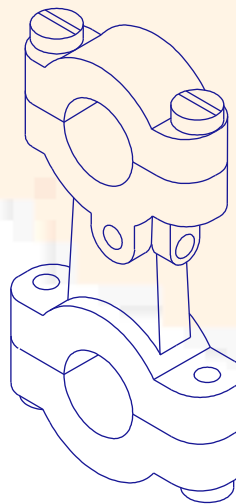

KJ-01B
VA1202821

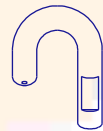

KJ-06B
VA1200126

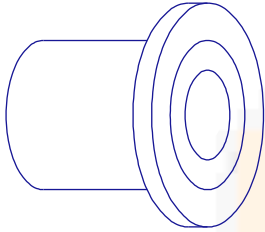

KT-42
VA1208012

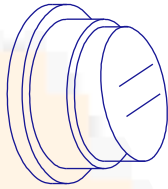

KT-44
VA1208013



KT-43
VA1208011

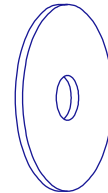

KD-24
VA1202819

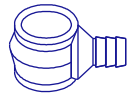

KT-24
VA120801

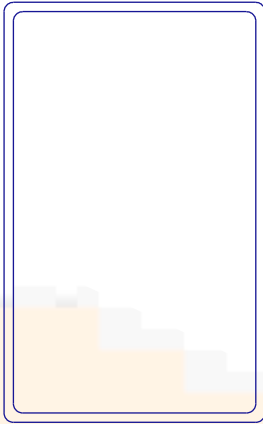

KT-52
VA12008031

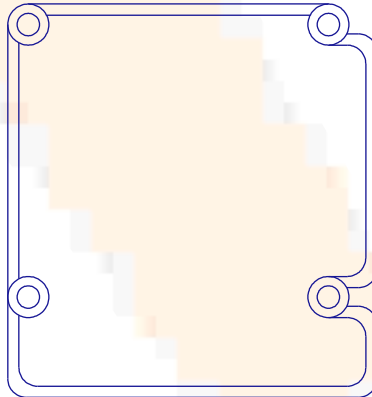

KC-03
VA12008026

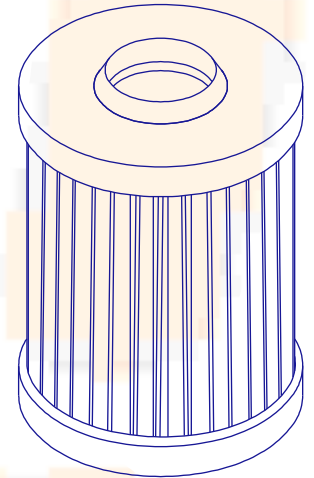

KT-14
VA12008035

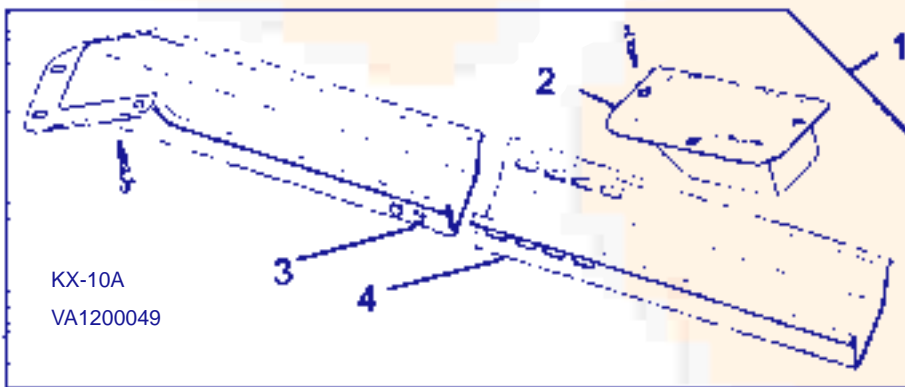

KX-10A
VA1200049

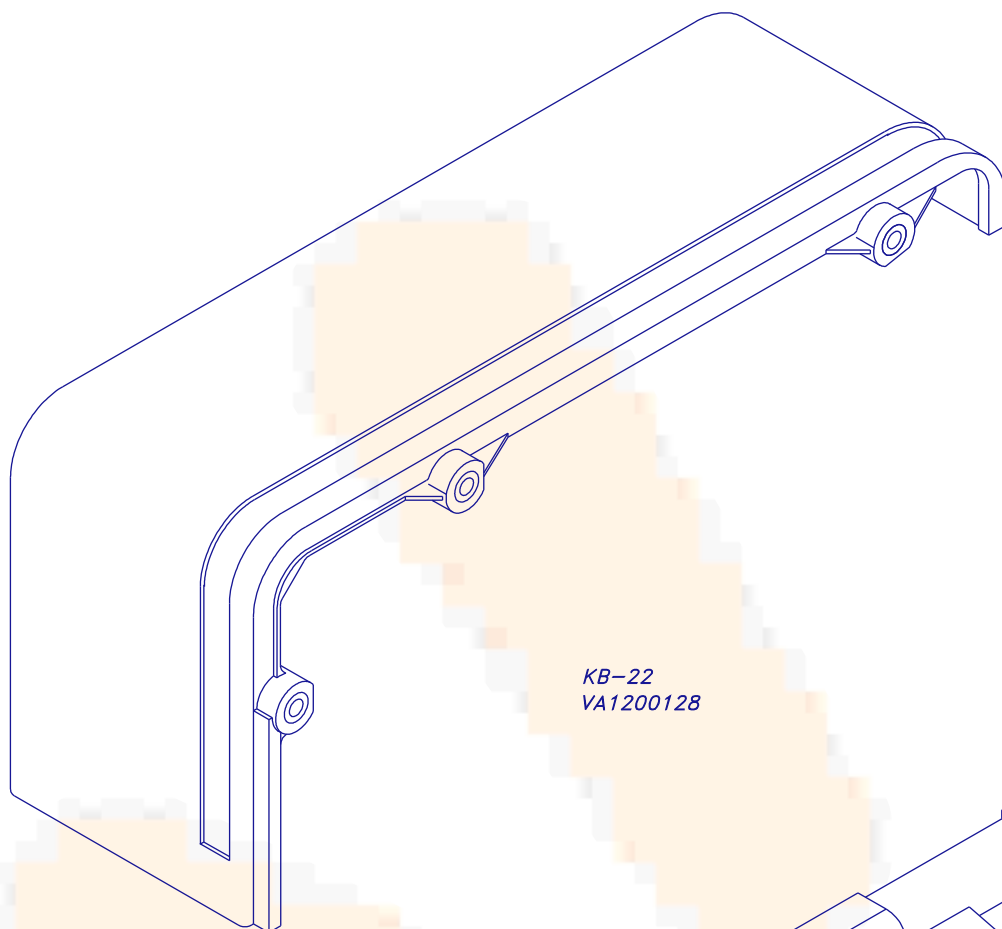

KB-22
VA1200128

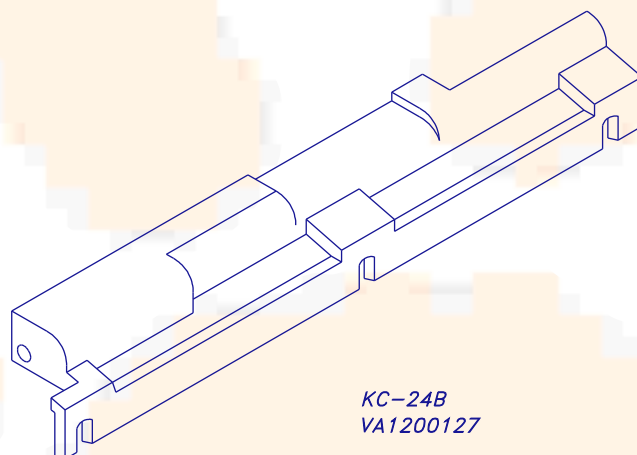

KC-24B
VA1200127

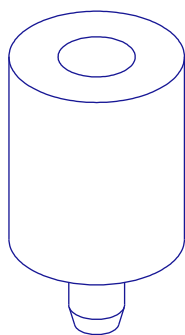

KX-02
VA1202824

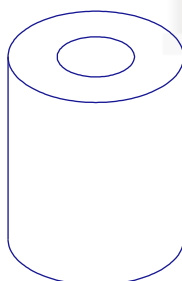

KX-03
VA1202825



FRUNCIDOR

REFERENCIA
1
737-GA(0X4)+R
747-GA(2X4)+R
747-GA(2X5)+R
757-GA(3X3)+R
757-GA(3X5)+R
757-GA(5X5)+R
2
GA

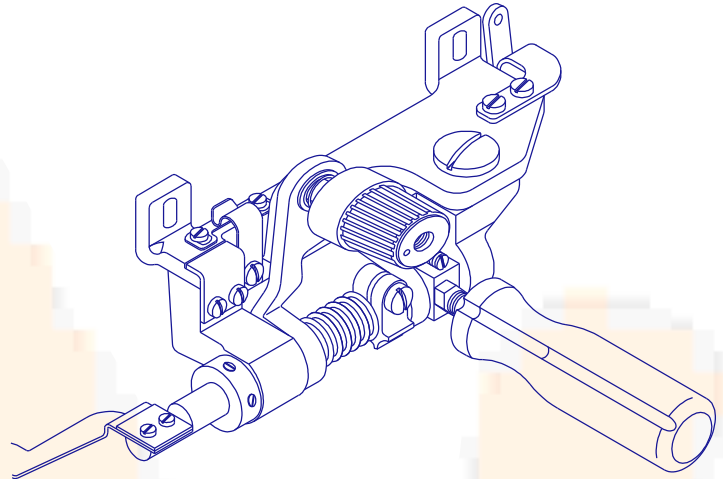

REFERENCIA	
3	
KV-16 (0X4,2X4,2X5)	
KV-17 (3X3,3X5,5X5)	
4	
E-800 (0X4)	
E-919 (2X4)	
E-920 (2X5)	
E-980 (3X3)	
E-982 (3X5)	
E-986 (5X5)	

REFERENCIA	
5	
H-959 (0X4,2X4,2X5)	
H-957 (3X3,3X5,5X5)	
6	
D-996 (0X4,2X4,2X5)	
D-002 (3X3,3X5)	
D-003 (5X5)	

REFERENCIA	
7	
P-136 (0X4,2X4,2X5)	
P-508 (3X3,3X5)	
P-509 (5X5)	



PLACA AGUJAS

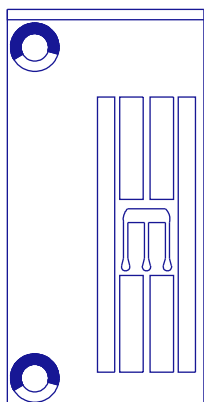

257018B56
PA29435

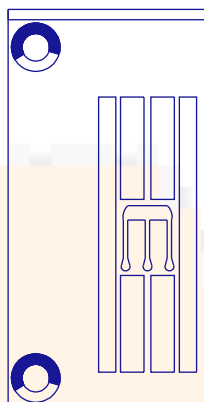

257018B64
PA29436

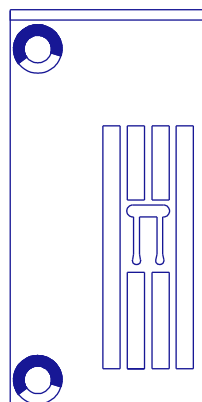

257015A40
PA29421

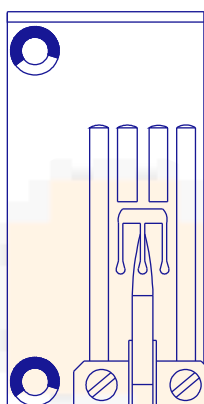

257006C64
PA29433

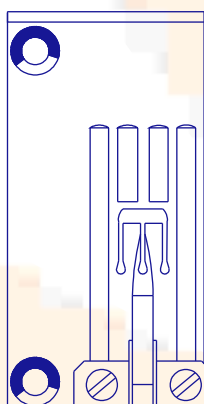

257094(B-C)56
PA29434

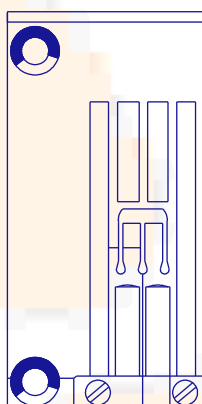

257018D64
PA29437

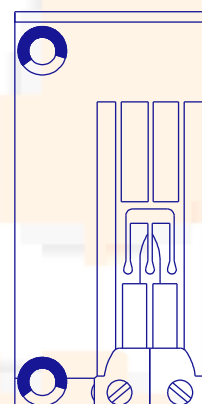

257018C56
PA29239

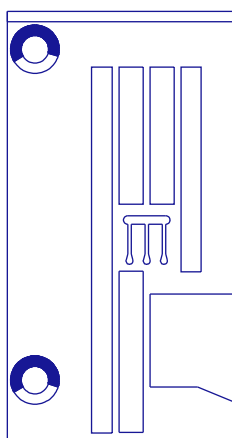

257053B56
PA29231

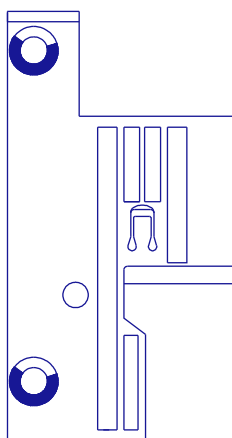

257157B32
PA29445

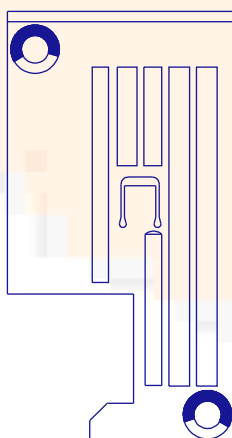

257100C48
PA29336



PLACA AGUJAS

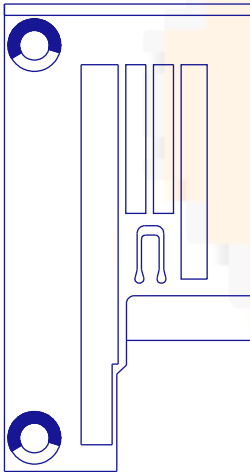

257029B32 → 3,2 mm
PA29451

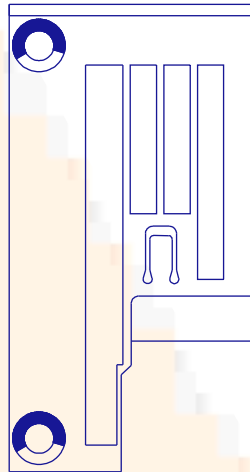

257030B40 → 4 mm
PA29452

257030B48 → 4,8 mm
PA29453

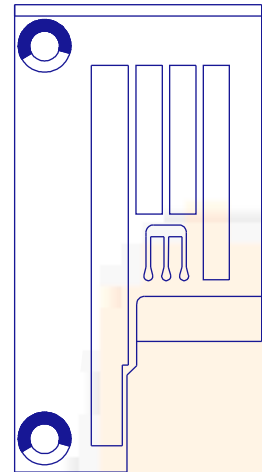

257033B56
PA29448

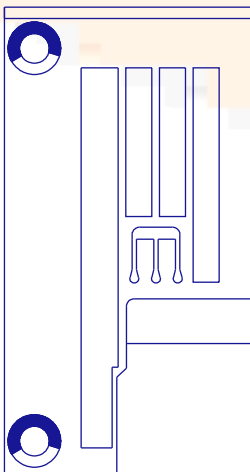

257033B64
PA29449

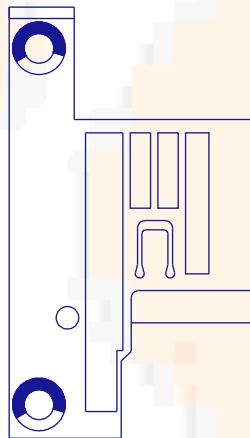

257024A40 → 4 mm
PA29334

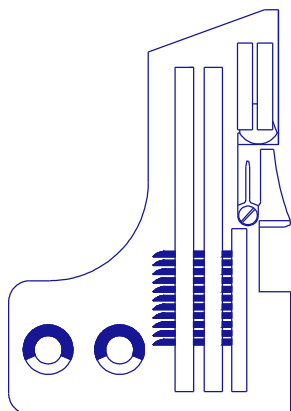

205243
PA29446

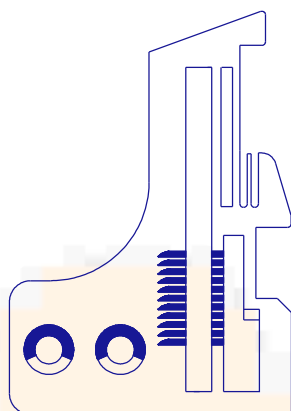

202675
PA29443

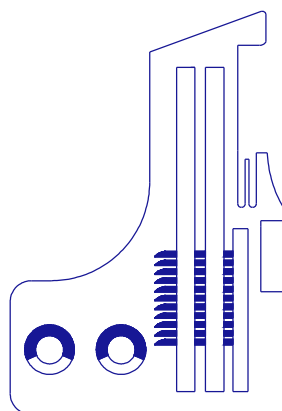

205255
PA29444

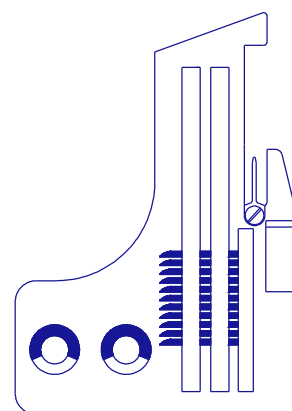

202554E
PA29440

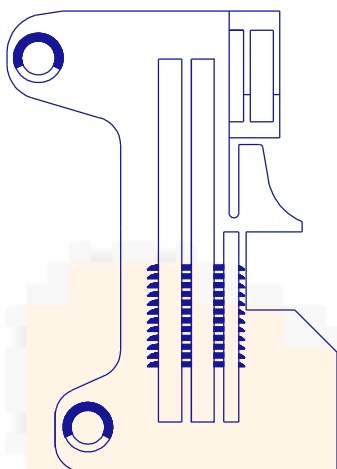

277504R50
PA29338

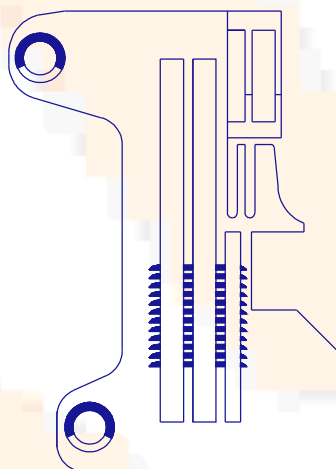

277505R40
PA29337

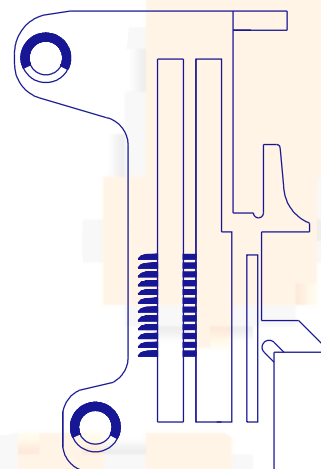

277535A40
PA29335

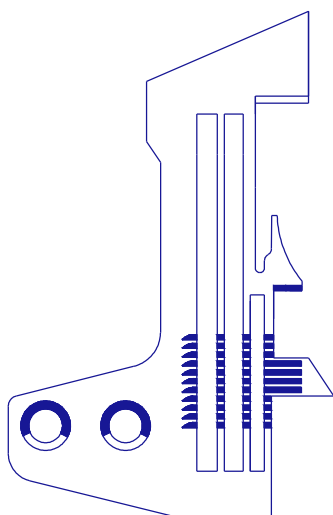

213548-40
PA29228

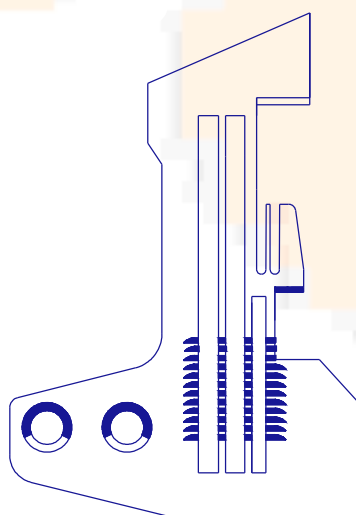

210805
PA29447



PRENSATELAS

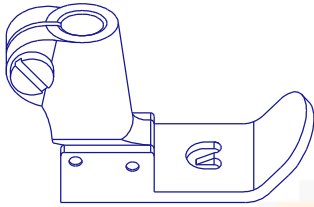

257300A32
PS29421 1/8"
257300A40
PS29424

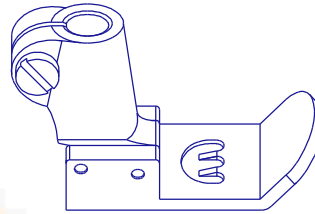

206302/1
PS29434
206300/1
PS29432

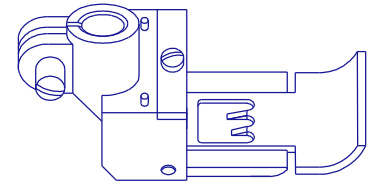

257301A64
PS29433
257301A56
PS29431

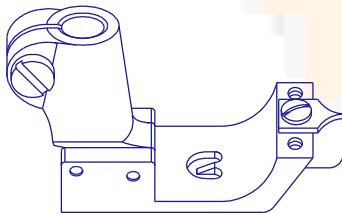

257403-40 5/32"
PS29422
257403-48 3/16"
PS29423

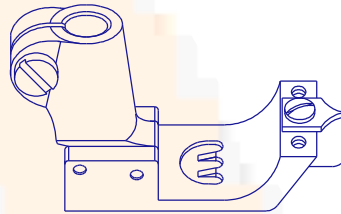

PRENSATELA SOBRECARGA
257313-64
PS29435
257313-56
PS29436

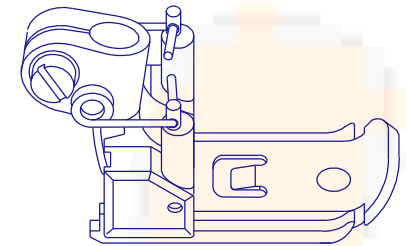

257302A40
PS29425
257300A48
PS29441

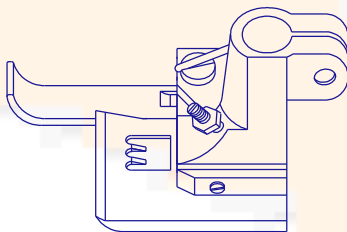

206443 7/32"
PS29331
206444 1/4"
PS29332

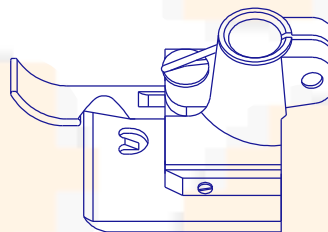

PS29321 (1/8)
PS29322 (5/32)

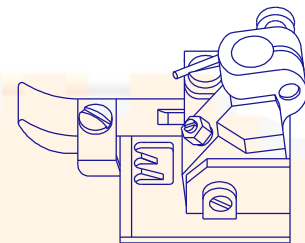

257420-56
PS29320

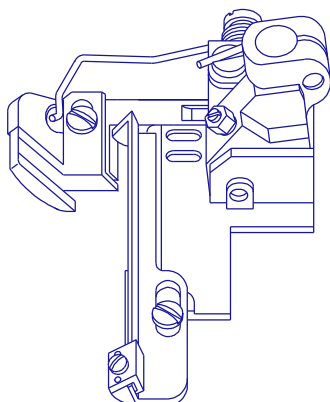

257333A48
PS29440

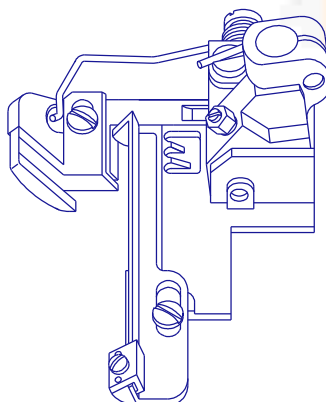

257420-64
PS29326

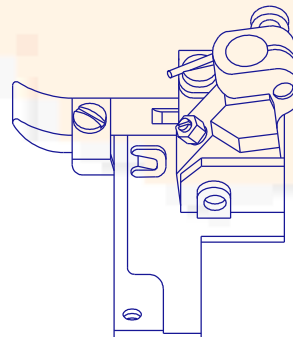



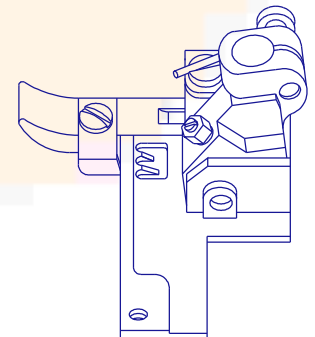



257317A32
PS29449

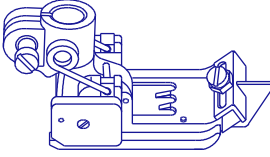
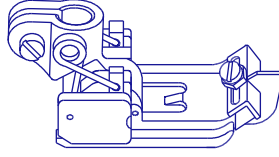

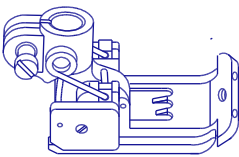
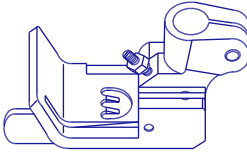
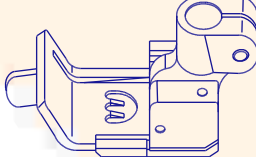
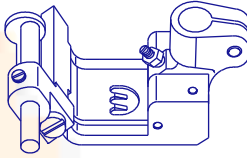
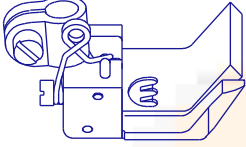
257320A48
PS29324

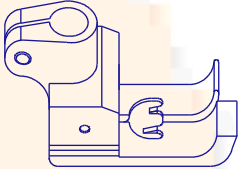
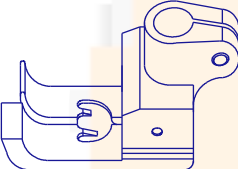

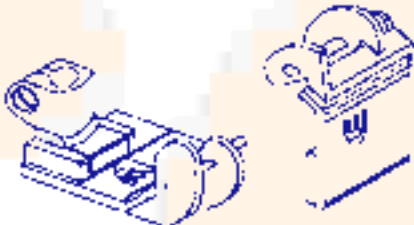
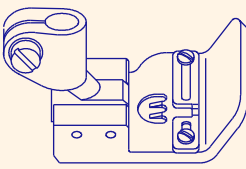
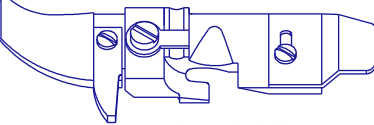
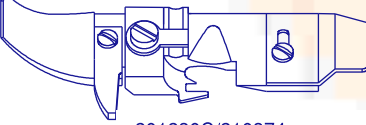
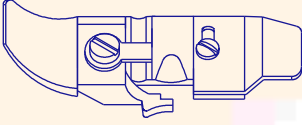
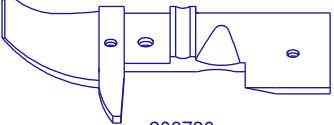
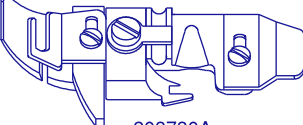
 <p>528B-356 PS20442 528B-364 PS20441</p>	 <p>528B-240 PS20444 528B-248 PS20445</p>	 <p>528B-SC VA20817</p>  <p>528B-G VA20816</p>	 <p>206302 PS29325</p>
 <p>528HR-356 PS20449 528HR-364 PS20439</p>	 <p>528HL-364 PS20437</p>	 <p>528D-356 PS20443 528D-364 PS20436</p>	 <p>528L-364 PS20438</p>
<p><u>PRENSATELAS DE TEFLÓN</u></p>  <p>BASES</p> <p>528T-40 528T-48 528T-56 528T-64</p> <p>528TB-40 528TB-48 528TB-56 528TB-64</p>		 <p>3100R-356 PS20450 3100R-364 PS20451</p>	 <p>3100L-356 PS20452 3100L-364 PS20453</p>
 <p>528K-40 528K-48 528K-56 528K-64</p>	 <p>529E-56</p>	 <p>528E-364 PS20440</p>	
 <p>202799/210371 PS29439</p>	 <p>201230C/210374 PS29437</p>	 <p>202799/205525 PS29319</p>	
 <p>208730 PS29323</p>		 <p>208730A PS29438</p>	

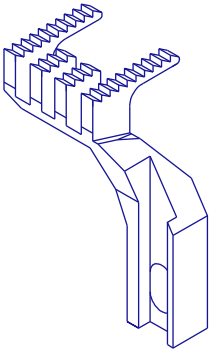

257200-16F
DT29434

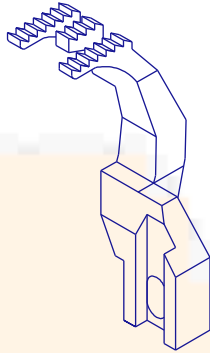

257253-16F
DT29433

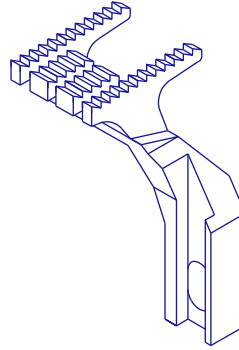

257207-16F
DT29333

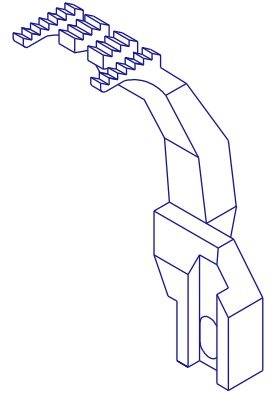

257259-16F
DT29334

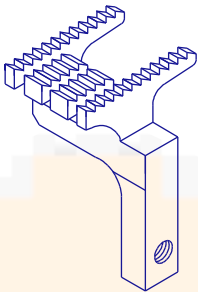

257242-16F
DT29446

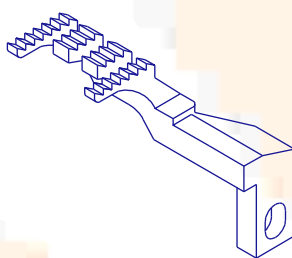

257289-16F
DT29447

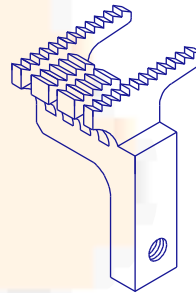

257243-16F
DT29448

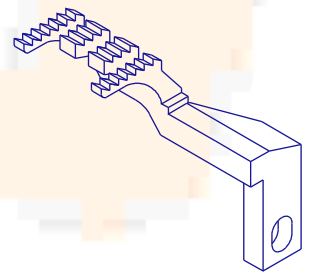

257290-16F
DT29449

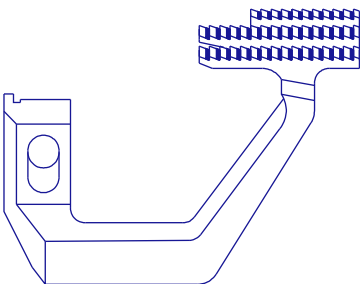

277305-16F
DT29455

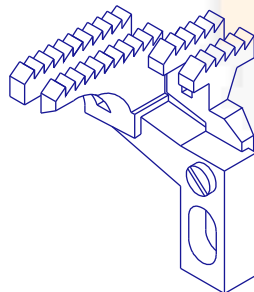

277303-16F
DT29454

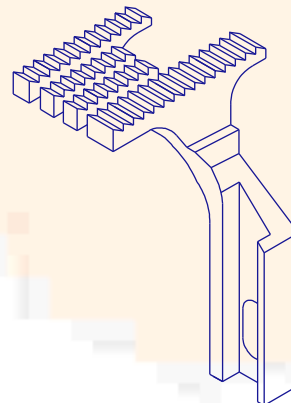

257214-16F
DT29340

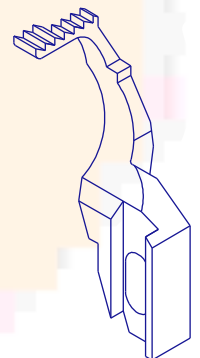

257260-16F
DT29339

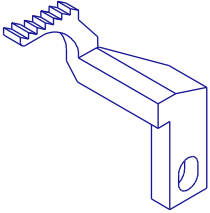

257292-16F
DT29338

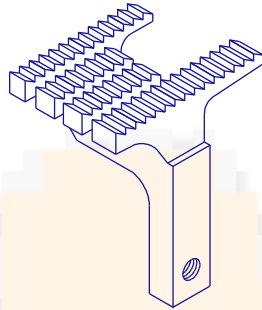

257245-16F
DT29450

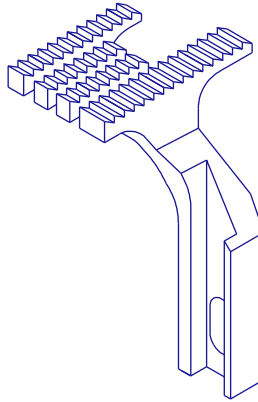

257202-16F
DT29336

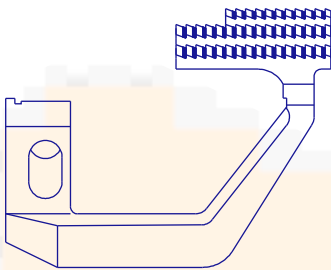

210445-BF
DT29335

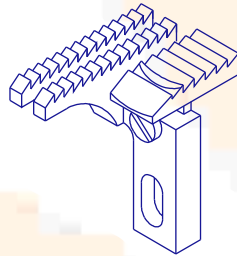

210574-BF
DT29451

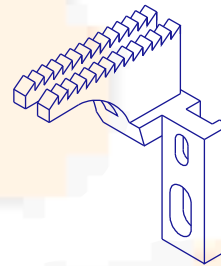

204675
DT29337

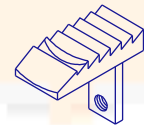

204674
DT29330

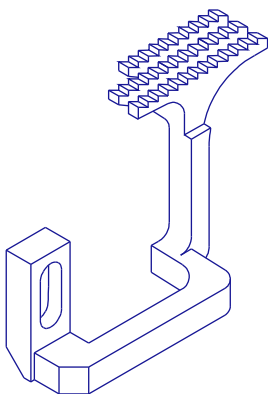

204676-BF
DT29443

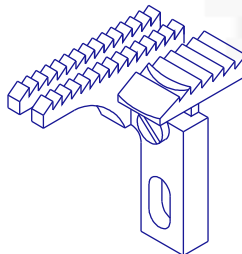

208078-BF
DT29442

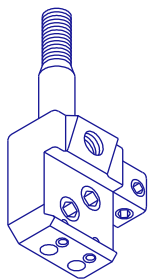

257517-32
SA29439

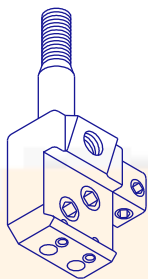

257517-40
SA29438

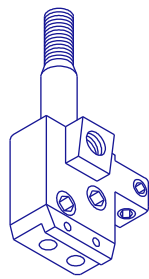

257517-48
SA29435

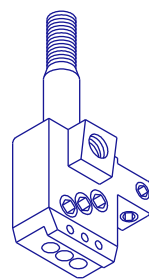

257518-48
SA29437

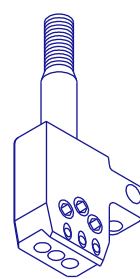

257544-56
SA29427

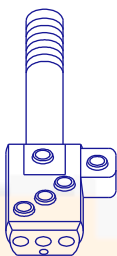

257518-56 7/32"
SA29434

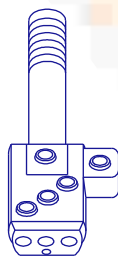

257518-64 1/4"
SA29433



208905
SA29436

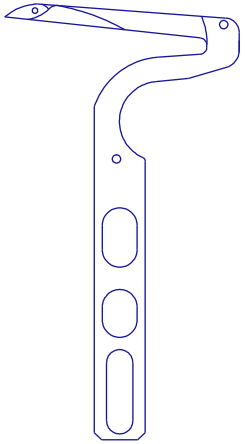

204072
AN29407

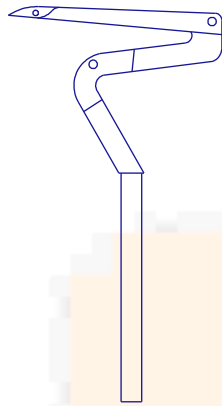

202703
AN29001

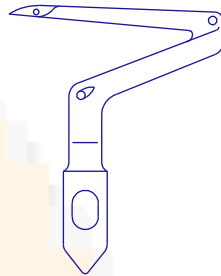

277015
AN29406

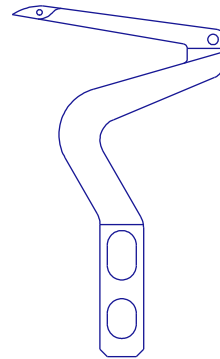

212215
AN29398
212215J
AN29396

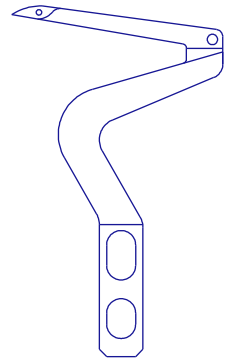

212644
AN29397
212644J
AN29395

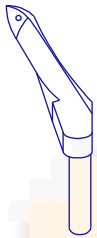

204949
AN29408



277011
AN29405



277010
AN29393



204062-PG
AN29404

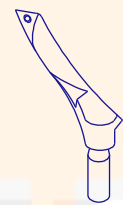

210364
AN29409

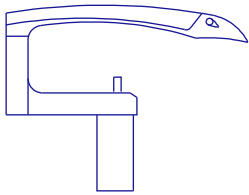

257550
AN29402

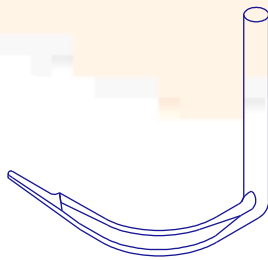

257552
AN29401

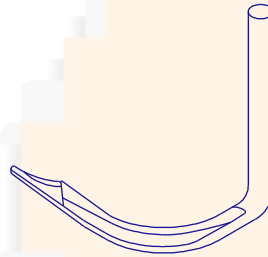

257565
AN29403



257566
AN29400

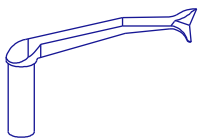

277014
AN29399

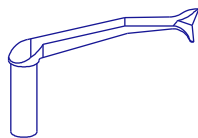

277014A
AN29394



138559
CH29001

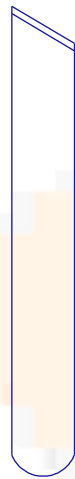

137562
CH29002



277009
CH29206



204161
CH29201

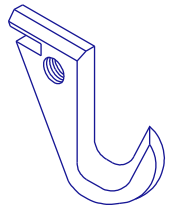

306394/1
CH29203

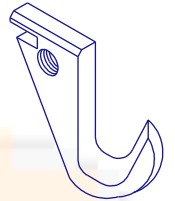

306394
CH29202

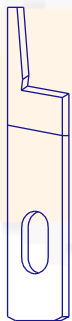

201121A
CH29200



277000
CH29205



202295
CH29204



350024
CH29000



350220
CH29007

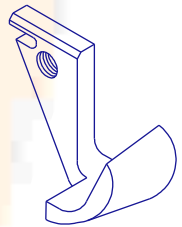

257573
CH29004

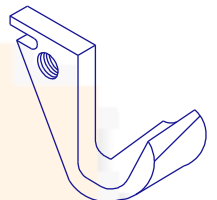

257574
CH29003

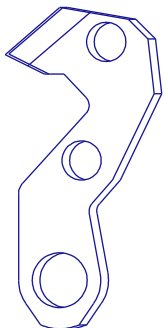

308308
CH29005

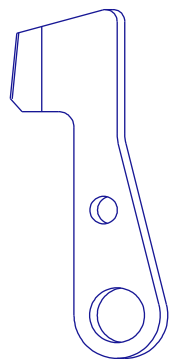

301008
CH29006

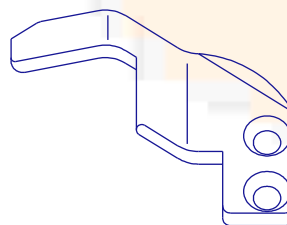

258037
VA29120



W664-01 CA, CB, CC

BORAS 2 AGUJAS 4 mm



257517-40
SA29438

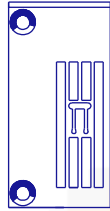

257015A40
PA29421

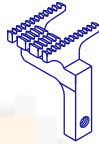

257242-16F
DT29446

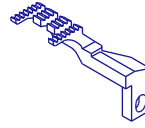

257289-16F
DT29447

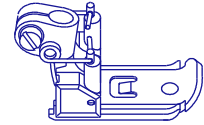

257300A40
PS29424

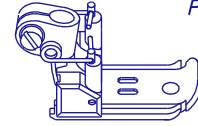

257302A40
PS29425

W664-01 CA, CB, CC BORAS 3 AGUJAS 5,6 Y 6,4 mm



257518-56
SA29434
257518-64
SA29433

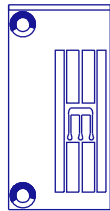

257018B56
PA29435
257018B64
PA29436

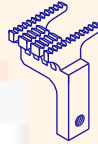

257243-16F
DT29448

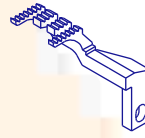

257290-16F
DT29449

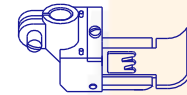

257301A56 → 5,6 mm
PS29431
257301A64 → 6,4 mm
PS29433

BORAS 3 AGUJAS



201855
SA29431



206276 7/32"
PA29431

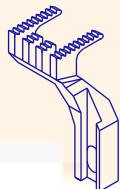

206279
DT29432

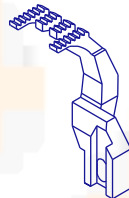

206283
DT29431

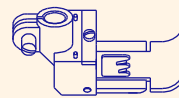

257301A56
PS29431

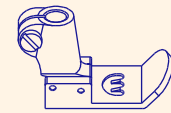

206300/1
PS29432

BORAS 3 AGUJAS 1/4"

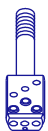

201856 1/4"
SA29432

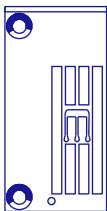

206277
PA29432

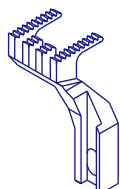

206279
DT29432

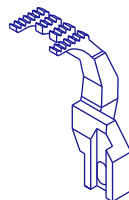

206283
DT29431

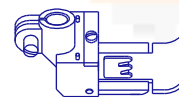

257301A64
PS29433

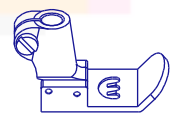

206302/1
PS29434



W664-02 BA, BB, BC

TIRA 2 AGUJAS 3,2 mm

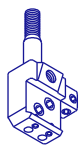

257517-32
SA29439

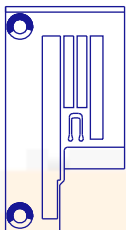

257029B32
PA29451

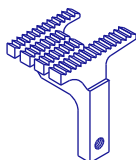

257244-16F
DT29329

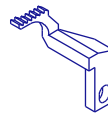

257291-16F
DT29328

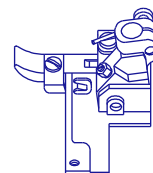

257317A32
PS29449

W664-02 BA, BB, BC

TIRA 2 AGUJAS 4 Y 4,8 mm

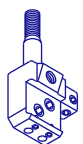

257517-40
SA29438

257517-48
SA29435

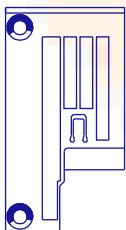

257030B40
PA29452

257030B48
PA29453

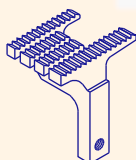

257245-16F
DT29450

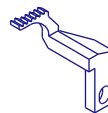

257292-16F
DT29338

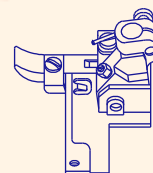

257318A40
PS29420

257318A48
PS29327

W664-02 BA, BB, BC

TIRA 3 AGUJAS 5,6 mm

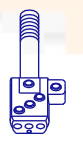

257518-56
SA29434

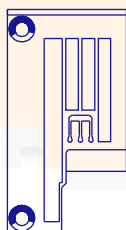

257033B56
PA29448

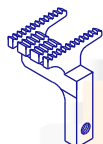

257246-16F
DT29452

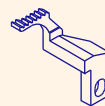

257293-16F
DT29453

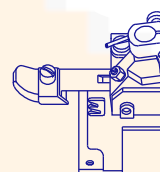

257321A56
PS29447

W664-02 BA, BB, BC

TIRA 3 AGUJAS 6,4 mm



257518-64
SA29433

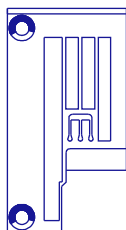

257033B64
PA29449

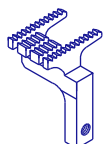

257246-16F
DT29452

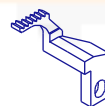

257293-16F
DT29453

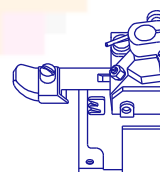

257321A64
PS29448



TIRAS 3 AGUJAS

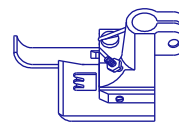
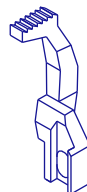
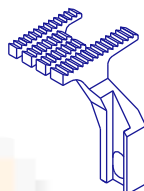
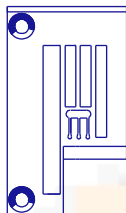

257518-56 7/32"
SA29434

206455 7/32"
PA29332

206281
DT29332

206285
DT29331

206443 7/32"
PS29331

TIRAS 3 AGUJAS

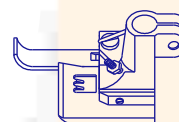
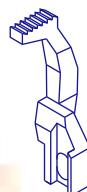
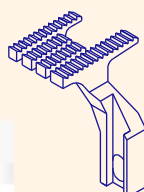
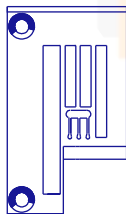

257518-64 1/4"
SA29433

206456 1/4"
PA29331

206281
DT29332

206285
DT29331

206444 1/4"
PS29332

W561/W562-05 BA,BB,CA,CB

PUNTILLA 2 AGUJAS 3,2 mm

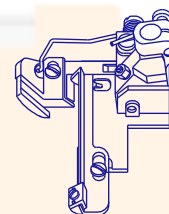
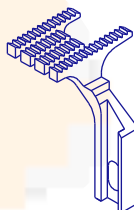
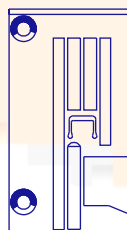

257517-32
SA29439

257049B32
PA29450

257220-16F
DT29445

257266-16F
DT29444

257327A32
PS29444

W561/W562-05 BA,BB,CA,CB

PUNTILLA 2 AGUJAS 4 mm

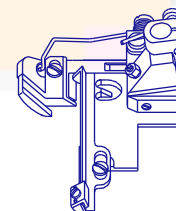
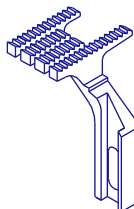
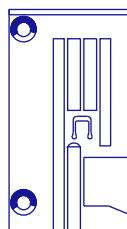
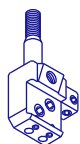

257517-40
SA29438

257050B40
PA29441

257221-16F
DT29436

257267-16F
DT29437

257328A40
PS29446



W561/W562-05 BA, BB, CA, CB PUNTILLA 2 AGUJAS 4,8 mm

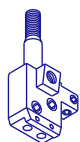

257517-48
SA29435

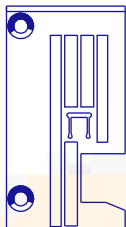

257050B48
PA29442

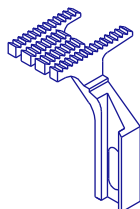

257221-16F
DT29436



257267-16F
DT29437

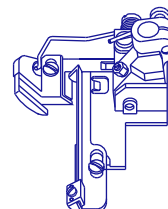

257328A48
PS29443

W561/W562-05 BA, BB, CA, CB PUNTILLA 2 AGUJAS 6,4 mm



257517-64
SA29430

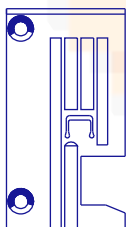

257052B64
PA29438

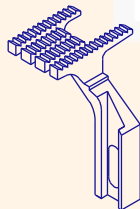

257222-16F
DT29439



257268-16F
DT29438

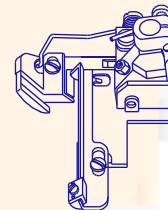

257329A64
PS29450

W561/W562-05 BA, BB, CA, CB PUNTILLA 3 AGUJAS 5,6 mm



257518-56
SA29434

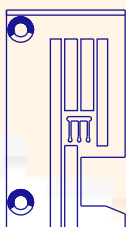

257053B56
PA29231

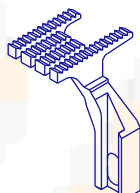

257222-16F
DT29439

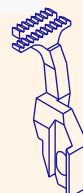

257268-16F
DT29438

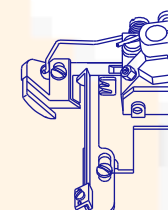

257331A56
PS29442

W561/W562-05 BA, BB, CA, CB PUNTILLA 3 AGUJAS 6,4 mm



257518-64
SA29433

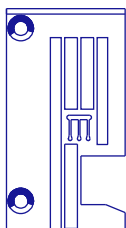

257053B64
PA29439

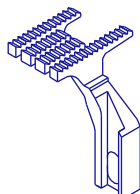

257222-16F
DT29439



257268-16F
DT29438

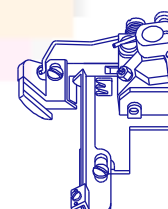

257331A64
PS29445



W664-05 BA, BB

PUNTILLA 2 AGUJAS 5,6 mm

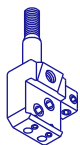

257517-56
SA29440

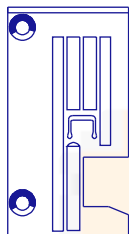

257052B56
PA29330

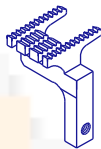

259106-16F
DT29440

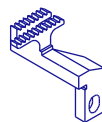

259218-16F
DT29441

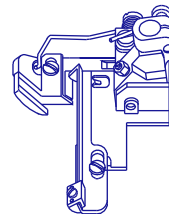

257420-56
PS29451

W664-05 BA, BB

PUNTILLA 2 AGUJAS 6,4 mm

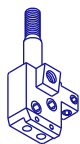

257517-64
SA29430

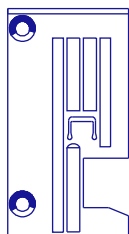

257052B64
PA29438

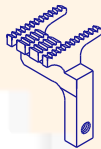

259106-16F
DT29440

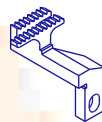

259218-16F
DT29441

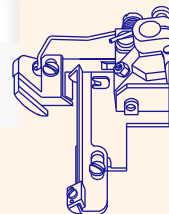

257420-64
PS29452



E52~E56

OWERLOCK 1 AGUJA 3 HILOS

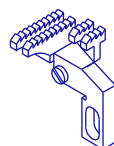
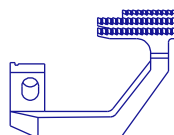
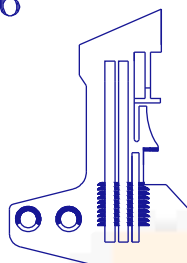

211358
SA29429

210799
PA29232
210800
PA29233
210801
PA29333

210445
DT29327

210575
DT29326

210371
PS29328

E52~E56

OWERLOCK 1 AGUJA

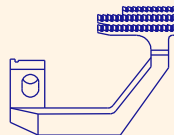
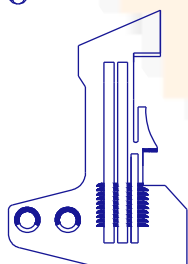

H-440
DT12013

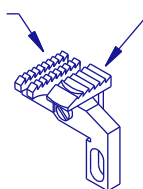

D-674
DT12028



211358
SA29429

210796
PA29234
210797
PA29235

210445-BF
DT29335

210574-BF
DT29451

210371
PS29328

E52~E56

OWERLOCK 2 AGUJAS 4 HILOS

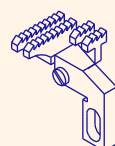
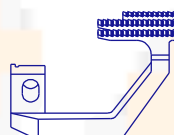
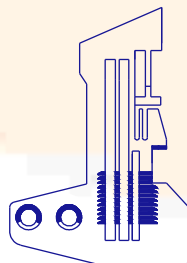

211360
SA29428

210809
PA29236
210810
PA29237

210445-BF
DT29335

210575-BF
DT29325

210374
PS29329

E52~E56

JUEGO OWERLOCK 2 AGUJAS 3 HILOS

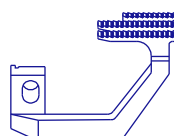
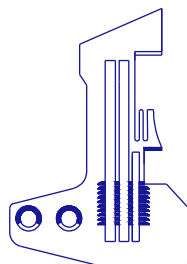

H-440
DT12013

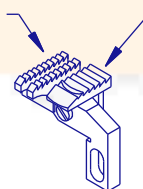

D-674
DT12028



211360
SA29428

210804
PA29238
210805
PA29447

210445-BF
DT29335

210574-BF
DT29451

210503
PS29330
210374
PS29329



M652-13

OWERLOCK 2 AGUJAS

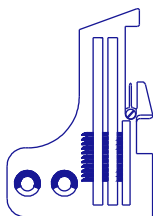

205255
PA29444

202554E
PA29440

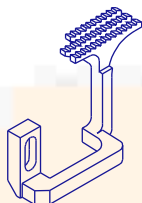

204676-BF
DT29443

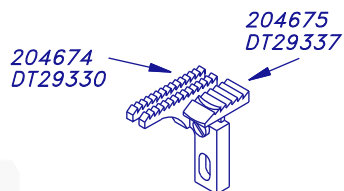

208078-BF
DT29442



208730A
PS29438

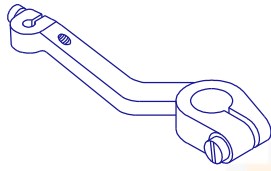

254516
VA2940202



234521
VA29105

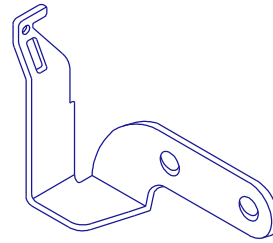

253506
VA29103

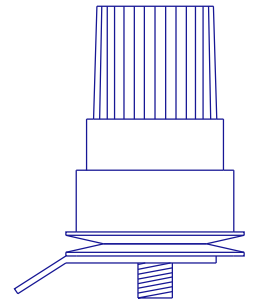

210529-9T
VA29128

210529-9U
VA29129



253514
VA29102

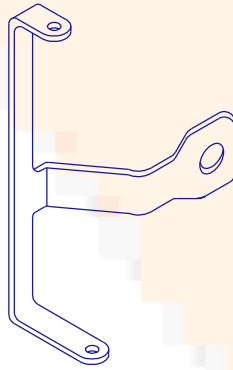

253515
VA29106

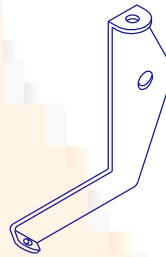

253547
VA29104

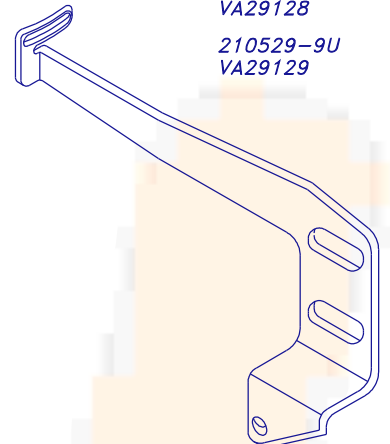

253548
VA29101

TENSOR OWERLOCK PEGASUS

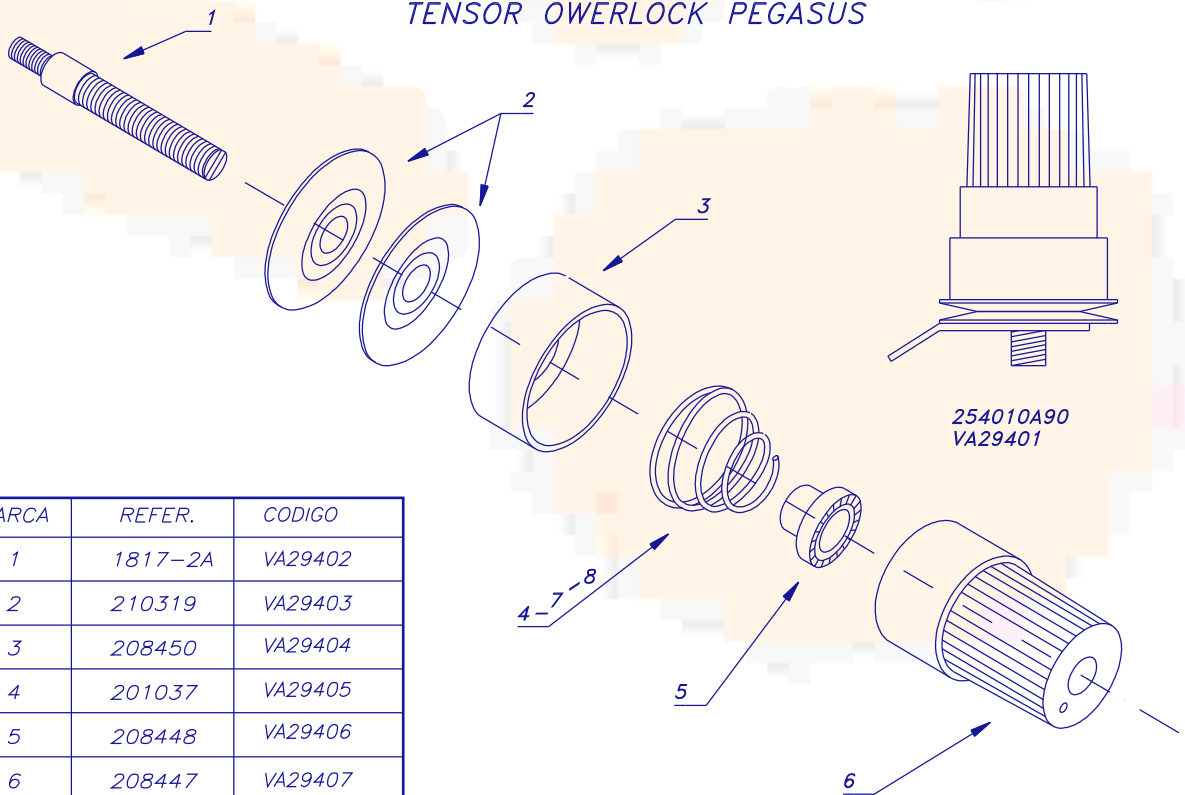

254010A90
VA29401

MARCA	REFER.	CODIGO
1	1817-2A	VA29402
2	210319	VA29403
3	208450	VA29404
4	201037	VA29405
5	208448	VA29406
6	208447	VA29407
7	201086	VA29408
8	201068	VA29409

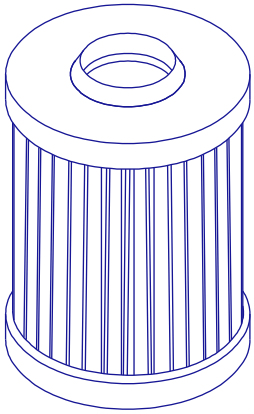

206233
VA29801

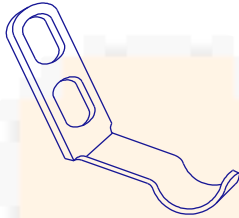

250051
VA29802

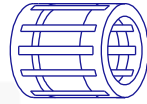

306239
VA29202

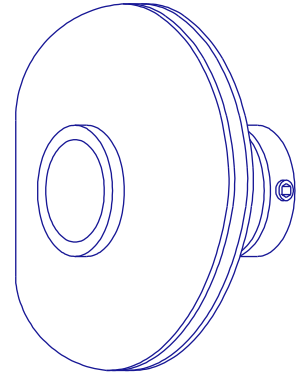

253589-91
VA29131

251000-91
VA29803



251014-91
VA29132

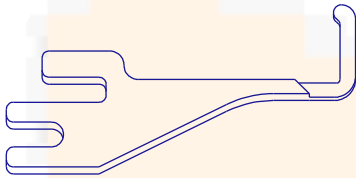
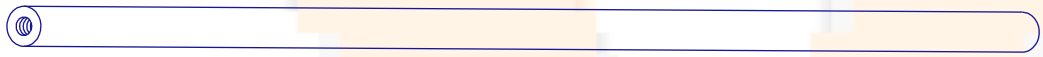

253599
VA29121

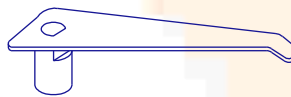

253595-91
VA29100

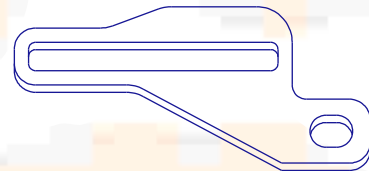

253680
VA29118



275017
VA29117

250167
VA29133

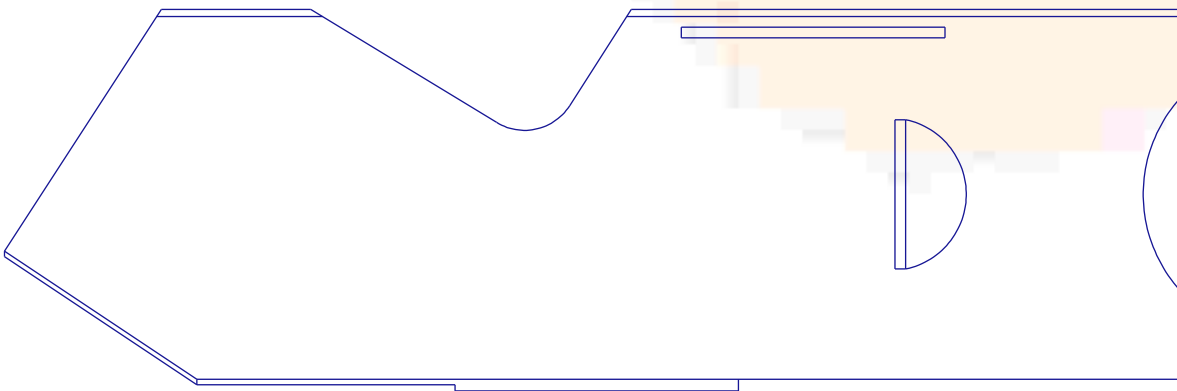

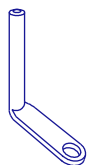

253511
VA29804

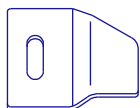

210584
VA29111

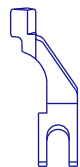

204659
VA29107



204634
VA29109

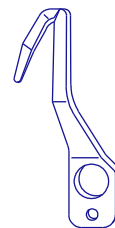

209009
VA29108



201224B
VA29110



204235
VA29806

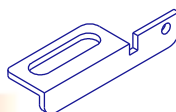

253533
VA29122

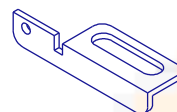

253534
VA29123

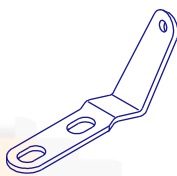

350224
VA29124



275019B
VA29126

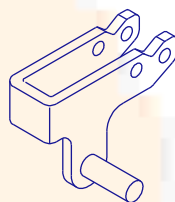

275013
VA29125

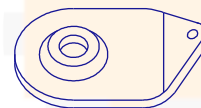

202849
VA29116

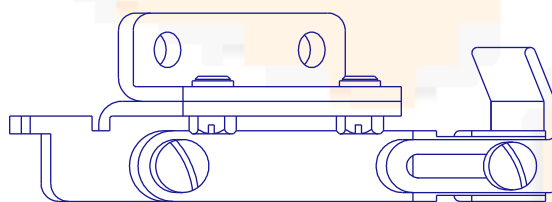

204449
VA73035

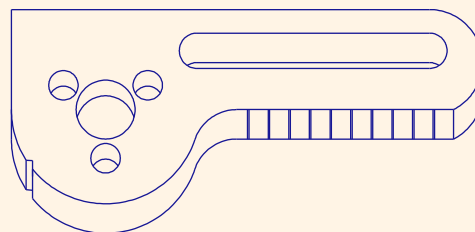

256010
VA29201



302670A91
AC29005



5644
AC29004



302671A91
AC29002

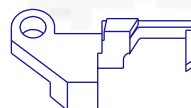

302672-A
AC29001



302674
AC29003



CORTANTES NEUMATICOS

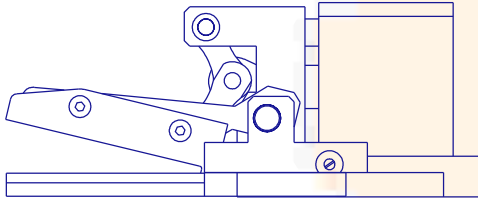

MR73
Corte útil.....50 mm

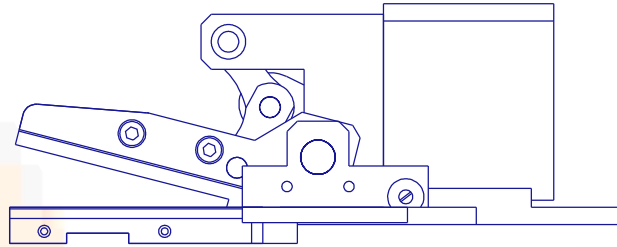

MR74
Corte útil.....50 mm

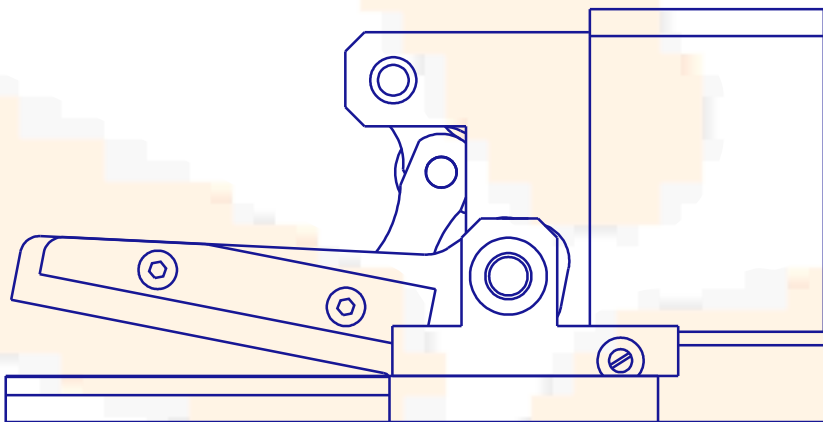

MR75
Corte útil.....70 mm



FRUNCIDOR

REFERENCIA
1
E52-242(0X4)+R
E52-242(0X5)+R
E52-243(0X4)+R
E52-243(0X5)+R

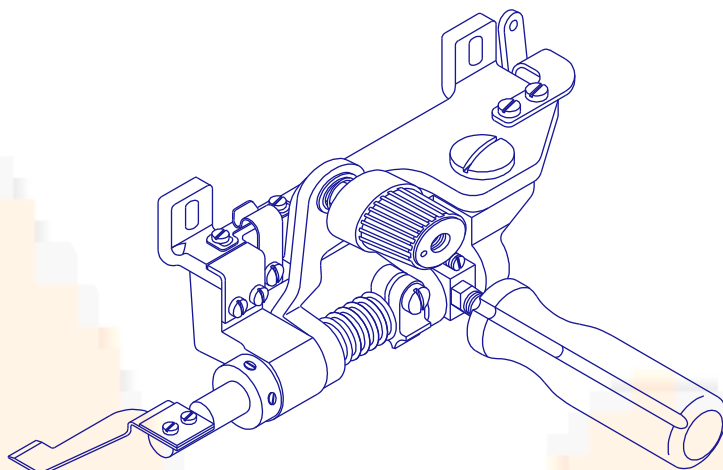

REFERENCIA	
3	
210800 (0X4)	
210801 (0X5)	
210809 (2X4)	
210810 (2X5)	
4	
210959-PG	

REFERENCIA	
5	
210996	
6	
205135 (0X4)	
205136 (2X4,2X5)	



JUEGO DE BORAS 2 AGUJAS

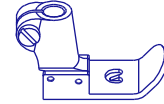
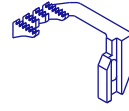
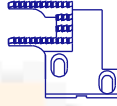
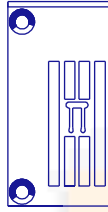
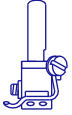

12-812 5/32"
SA20421

14-734 5/32"
PA20423

15-755
DT20411

15-724 5/32"
DT20412

17-834 5/32"
PS20422

JUEGO DE BORAS 3 AGUJAS

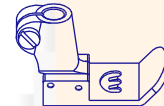
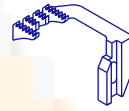
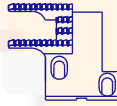
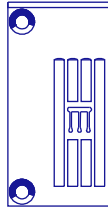

12-802 1/4"
SA20431

14-864 1/4"
PA20431

15-753
DT20422

15-723
DT20421

17-894 1/4"
PS20431

JUEGO COLLARIN 2 AGUJAS

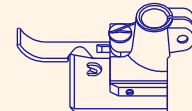
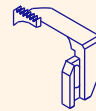
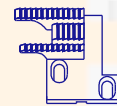
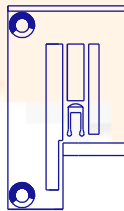
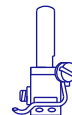

12-811 1/8"
SA20423

14-726 1/8"
PA20321

15-758
DT20321

15-729
DT20322

17-826 J
PS20218
17-826 1/8"
PS20322

JUEGO COLLARIN 3 AGUJAS

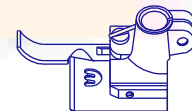
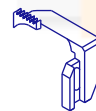
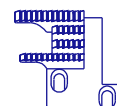
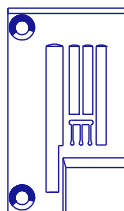

12-802 1/4"
SA20431

14-866 1/4"
PA20332

15-756
DT20331

15-727
DT20301

17-896 1/4"
PS20331



JUEGO DIENTE DE RATA

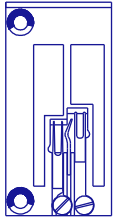

14-301
PA20427

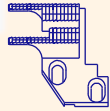

15-361
DT20424

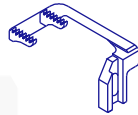

15-301
DT20423

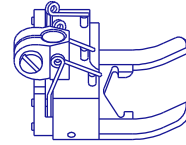

17-361
PS20429

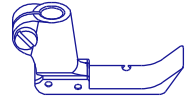

17-301
PS20943



WX8800D-5/32mm 2 AGUJAS

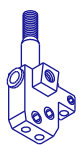

12-807
SA20443

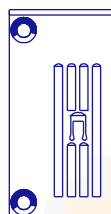

14-885
PA20211

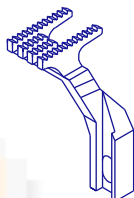

15-843
DT20327

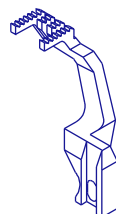

15-805
DT20326

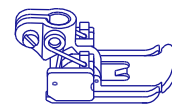

17-807
PS20211

WX8800D-3/16mm 2 AGUJAS

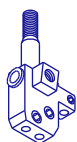

12-808
SA20444

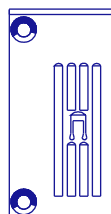

14-886
PA20212

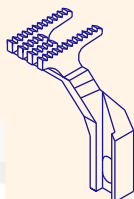

15-843
DT20327



15-805
DT20326

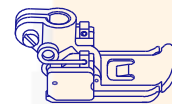

17-808
PS20207

WX8800D-7/32mm 3 AGUJAS

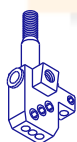

12-818
SA20445

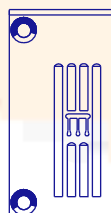

14-890
PA20213

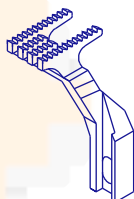

15-843
DT20327



15-805
DT20326

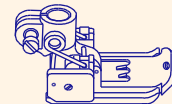

17-818
PS20208

WX8800D-1/4mm 3 AGUJAS

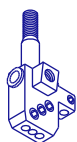

12-819
SA20446

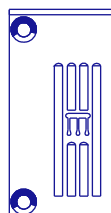

14-891
PA20214

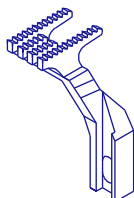

15-844
DT20328



15-807
DT20323

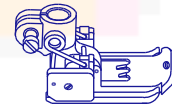

17-819
PS20210



WX8800F-5/32mm 2 AGUJAS

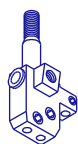

12-807
SA20443

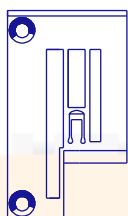

14-736
PA20322

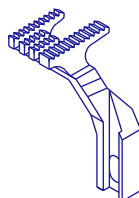

15-814
DT20332



15-813
DT20333

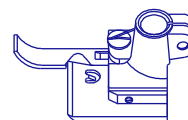

17-836J
PS20216
17-836
PS20321

WX8800F-3/16mm 2 AGUJAS

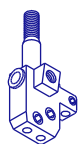

12-808
SA20444

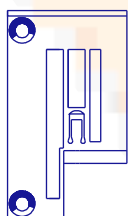

14-746
PA20323

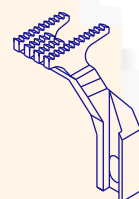

15-812
DT20325



15-811
DT20324

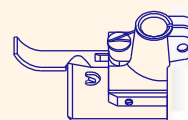

17-846J
PS20209
17-846
PS20323

WX8800F-7/32mm 3 AGUJAS



12-818
SA20445

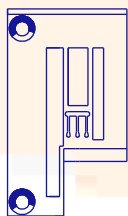

14-856
PA20331

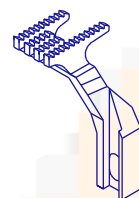

15-812
DT20325



15-811
DT20324

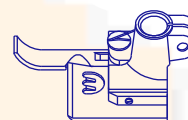

17-886J
PS20334
17-886
PS20332

WX8800F-1/4mm 3 AGUJAS

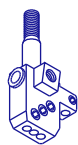

12-819
SA20446

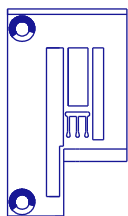

14-866
PA20332

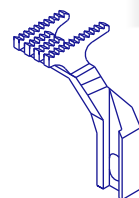

15-812
DT20325



15-811
DT20324

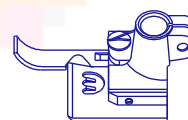

17-896J
PS20335
17-896
PS20331



WX8800-EMK-5/32mm 2 AGUJAS

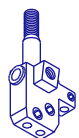

12-807
SA20443

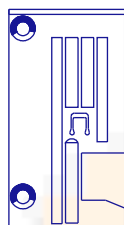

14-772
PA20215

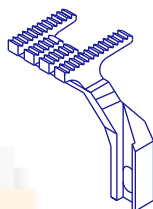

15-777
DT20329



15-776
DT20330

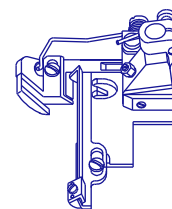

17-772
PS20212

WX8800-EMK-3/16mm 2 AGUJAS

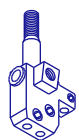

12-808
SA20444

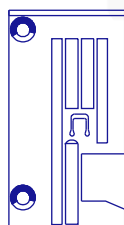

14-773
PA20216

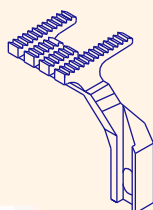

15-777
DT20329



15-776
DT20330

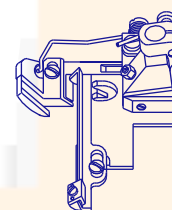

17-773
PS20213

WX8800-EMK-7/32mm 3 AGUJAS



12-818
SA20445

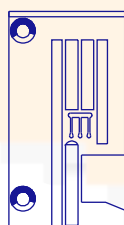

14-776
PA20217

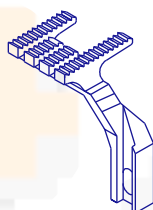

15-777
DT20329



15-776
DT20330

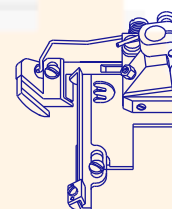

17-776
PS20214

WX8800-EMK-1/4mm 3 AGUJAS

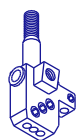

12-819
SA20446

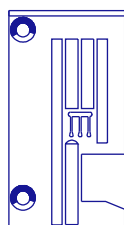

14-777
PA20218

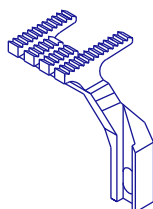

15-777
DT20329



15-776
DT20330

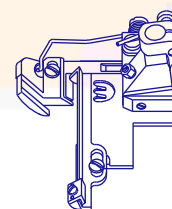

17-777
PS20215

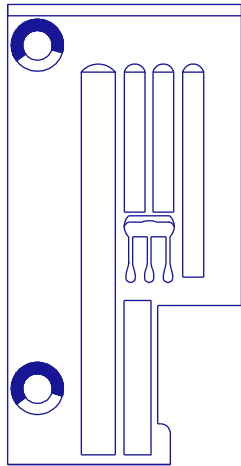

14-858B
PA20201
14-868
PA20202

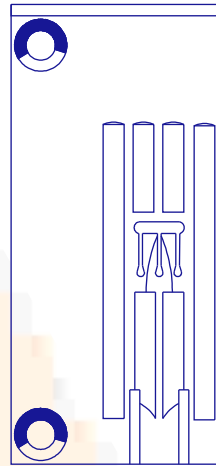

14-854C
PA20433

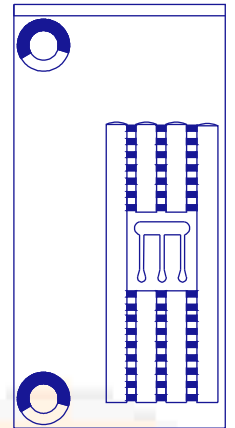

14-855
PA20420

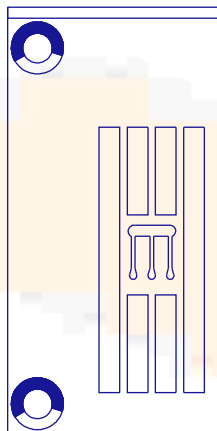

14-818
PA20219



PRENSATELAS



VA4043121

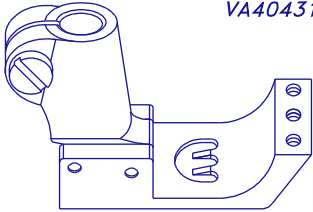

SOBRECARGA REGULABLE

2 AGUJAS

PS20423	1/8"
PS20424	5/32"
PS20426	3/16"

3 AGUJAS

K3030356	7/32"
PS20434	
K3030364	1/4"
PS20432	

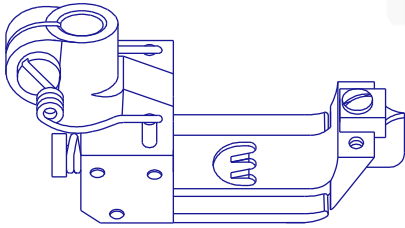

COMPENSADA

3 AGUJAS

PS2043	7/32
PS2043	1/4

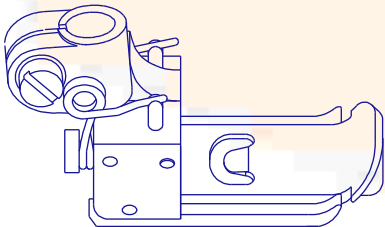

17-8570-1
PS20427

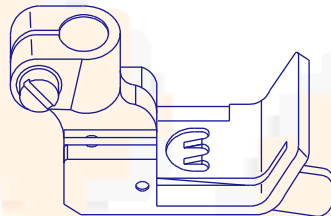

528HL-364
PS20437

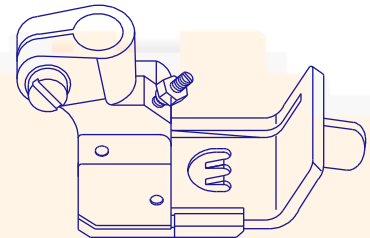

528HR-364
PS20439
528HR-356
PS20449

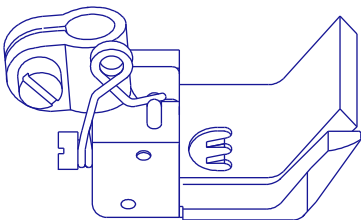

528L-364
PS20438

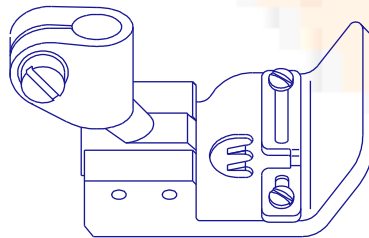

528E-364
PS20440

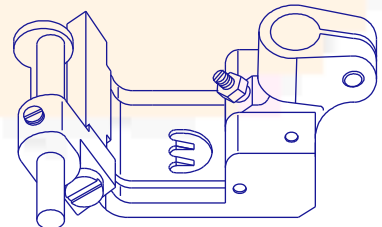

528D-364
PS20436
528D-356
PS20443

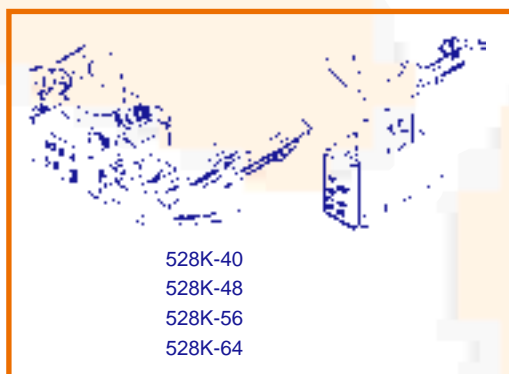
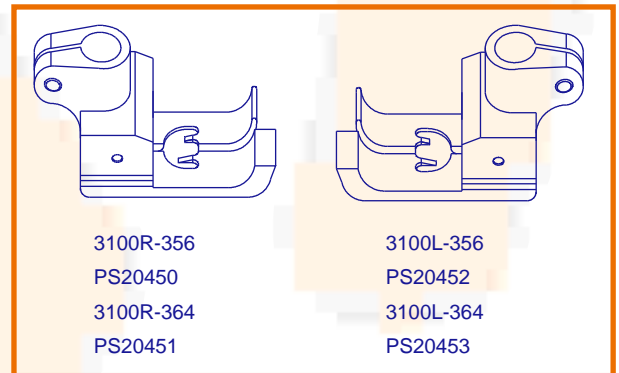
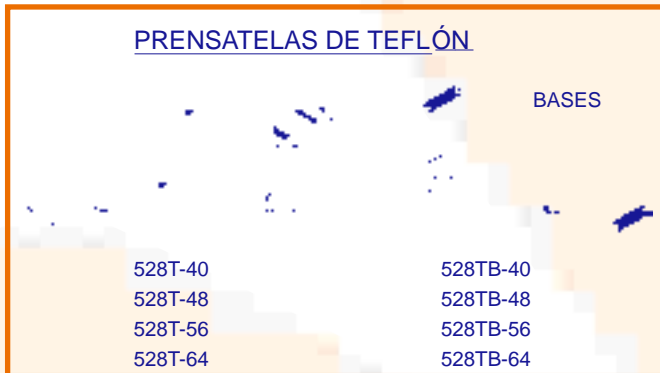
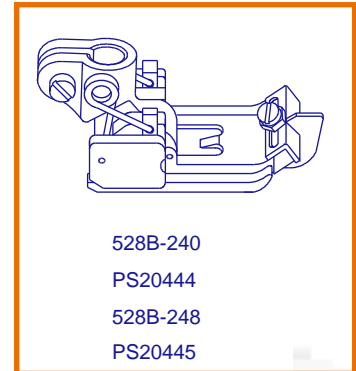
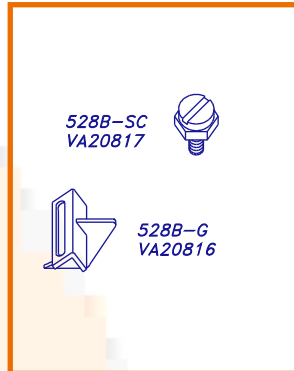
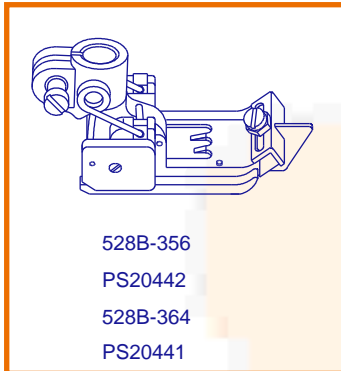

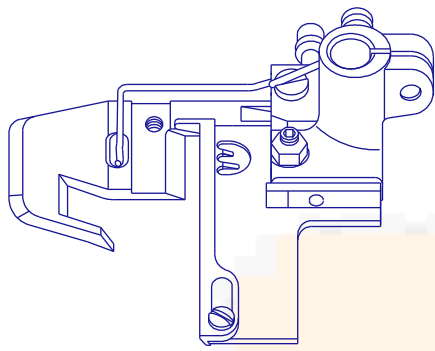

17-889
PS20230

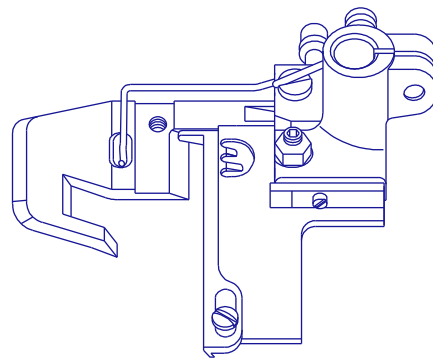

17-899
PS20231

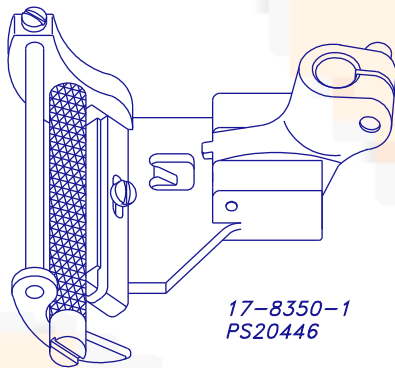

17-8350-1
PS20446

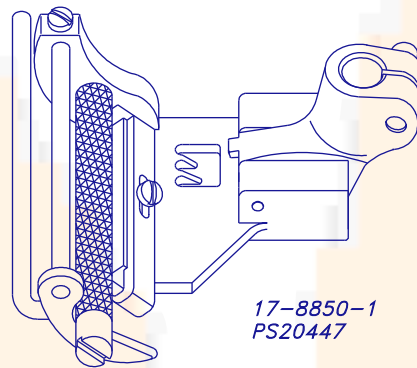

17-8850-1
PS20447

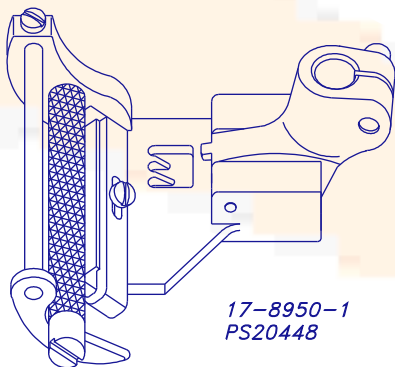

17-8950-1
PS20448

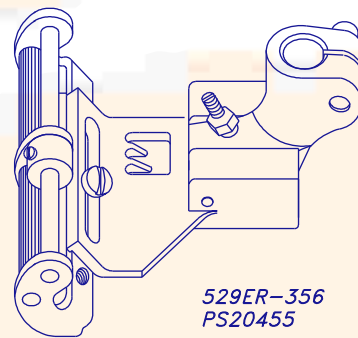

529ER-356
PS20455

529ER-364
PS20454

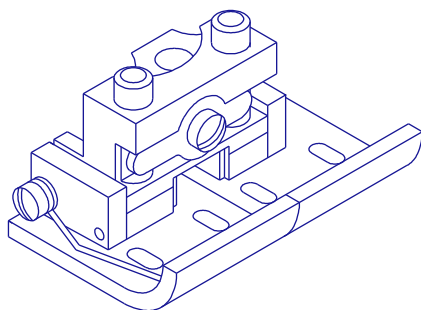

17-401 1"
PS20942



TABLA MAQUINA BORAS 2 Y 3 AGUJAS

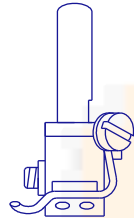

REF.	CODIGO	MEDIDA	
12-811	SA20423	1/8"	2 AGUJAS
12-812	SA20421	5/32"	
12-813	SA20422	3/16"	
12-814	SA20424	7/32"	
12-815	SA20425	1/4"	
12-801	SA20432	7/32"	3 AGUJAS
12-802	SA20431	1/4"	

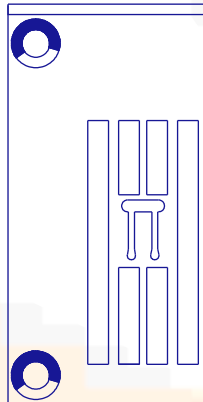

REF.	CODIGO	MEDIDA	
14-724	PA20425	1/8"	2 AGUJAS
14-734	PA20423	5/32"	
14-744	PA20422	3/16"	
14-754	PA20424	7/32"	
14-764	PA20426	1/4"	
14-854	PA20432	7/32"	3 AGUJAS
14-864	PA20431	1/4"	

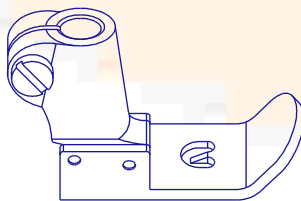

REF.	CODIGO	MEDIDA	
17-824	PS20421	1/8"	2 AGUJAS
17-834	PS20422	5/32"	
17-844	PS20425	3/16"	
17-854	PS20435	7/32"	
17-864	PS20428	1/4"	
17-884	PS20433	7/32"	3 AGUJAS
17-894	PS20431	1/4"	

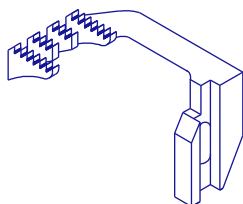

2 AGUJAS

15-724	1/8"
DT20412	5/32"
15-723	3/16"
DT20421	7/32"
	1/4"

3 AGUJAS

15-723	7/32"
DT20421	1/4"

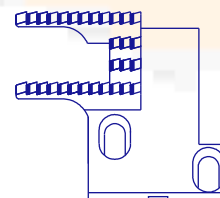

2 AGUJAS

15-755	1/8"
DT20411	5/32"
15-753	3/16"
DT20422	7/32"
	1/4"

3 AGUJAS

15-753	7/32"
DT20422	1/4"



TABLA MAQUINA COLLARIN 2 Y 3 AGUJAS

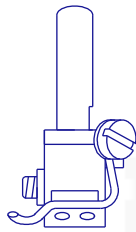

REF.	CODIGO	MEDIDA	
12-811	SA20423	1/8"	2 AGUJAS
12-812	SA20421	5/32"	
12-813	SA20422	3/16"	
12-814	SA20424	7/32"	
12-815	SA20425	1/4"	
12-801	SA20432	7/32"	3 AGUJAS
12-802	SA20431	1/4"	

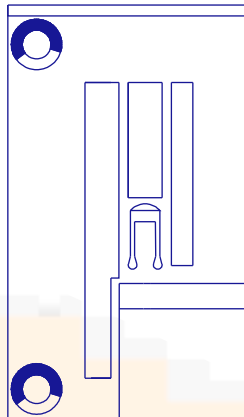

REF.	CODIGO	MEDIDA	
14-726	PA20321	1/8"	2 AGUJAS
14-736	PA20322	5/32"	
14-746	PA20323	3/16"	
14-756	PA20324	7/32"	
14-766	PA20325	1/4"	
14-856	PA20331	7/32"	3 AGUJAS
14-866	PA20332	1/4"	

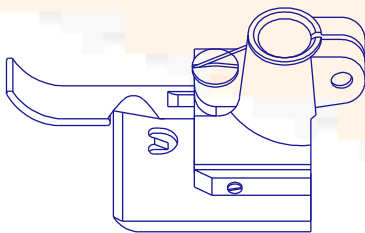

REF.	CODIGO	MEDIDA	
17-826	PS20322	1/8"	2 AGUJAS
17-836	PS20321	5/32"	
17-846	PS20323	3/16"	
17-856	PS20324	7/32"	
17-866	PS20325	1/4"	
17-886	PS20332	7/32"	3 AGUJAS
17-896	PS20331	1/4"	

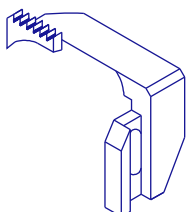

2 AGUJAS

15-729	1/8"
DT20322	5/32"
15-727	3/16"
DT20301	7/32"
	1/4"

3 AGUJAS

15-727	7/32"
DT20301	1/4"

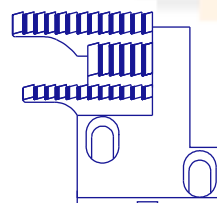

2 AGUJAS

15-758	1/8"
DT20321	5/32"
15-756	3/16"
DT20331	7/32"
	1/4"

3 AGUJAS

15-756	7/32"
DT20331	1/4"

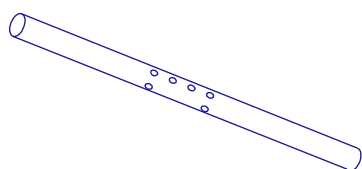
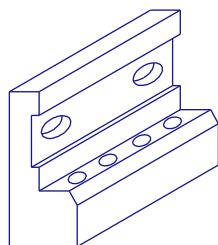
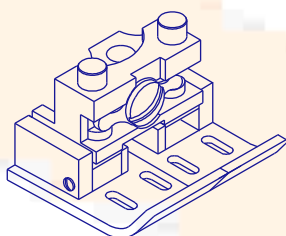
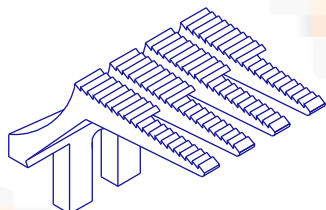
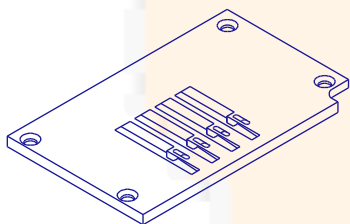
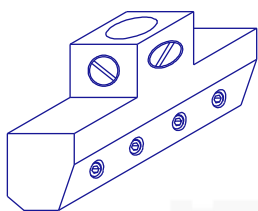

REF.	CODIGO	PULG. / mm.
12-419	SA20420	3/4" → 19,05
12-420	SA20433	7/8" → 22,22
12-421	SA20441	1" → 25,4
12-422	SA20442	1 1/8" → 28,57
12-423	SA20434	1 1/4" → 31,75
12-424	SA20430	1 1/2" → 38,1

REF.	CODIGO	PULG. / mm.
14-419	PA20206	3/4" → 19,05
14-420	PA20207	7/8" → 22,22
14-421	PA20204	1" → 25,4
14-422	PA20203	1 1/8" → 28,57
14-423	PA20208	1 1/4" → 31,75
14-424	PA20205	1 1/2" → 38,1

REF.	CODIGO	PULG. / mm.
15-419	DT20428	3/4" → 19,05
15-420	DT20429	7/8" → 22,22
15-421	DT20425	1" → 25,4
15-422	DT20426	1 1/8" → 28,57
15-423	DT20430	1 1/4" → 31,75
15-424	DT20427	1 1/2" → 38,1

REF.	CODIGO	PULG. / mm.
17-419	PS20201	3/4" → 19,05
17-420	PS20202	7/8" → 22,22
17-421	PS20333	1" → 25,4
17-422	PS20203	1 1/8" → 28,57
17-423	PS20205	1 1/4" → 31,75
17-424	PS20204	1 1/2" → 38,1

REF.	CODIGO	PULG. / mm.
19-419	SA20436	3/4" → 19,05
19-420	SA20437	7/8" → 22,22
19-421	SA20426	1" → 25,4
19-422	SA20428	1 1/8" → 28,57
19-423	SA20438	1 1/4" → 31,75
19-424	SA20427	1 1/2" → 38,1

REF.	CODIGO	PULG. / mm.
18-419	VA20800	3/4" → 19,05
18-420	VA20818	7/8" → 22,22
18-421	VA20805	1" → 25,4
18-422	VA20808	1 1/8" → 28,57
18-423	VA20819	1 1/4" → 31,75
18-424	VA20813	1 1/2" → 38,1

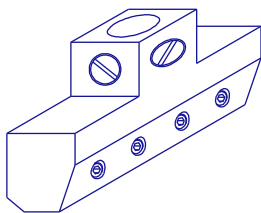

REF.	CODIGO	PULG.	/	mm.
12-429	SA20429	1/4"-1"-1/4"	→	6,35-25,5-6,35
12-430	SA20435	3/16"-1"-3/16"	→	4,76-25,4-4,76

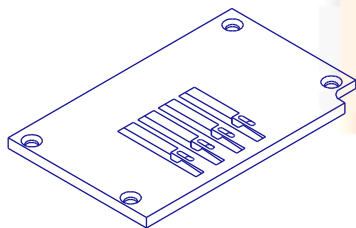

REF.	CODIGO	PULG.	/	mm.
14-431	PA20209	1/4"-1"-1/4"	→	6,35-25,5-6,35
14-432	PA20210	3/16"-1"-3/16"	→	4,76-25,4-4,76

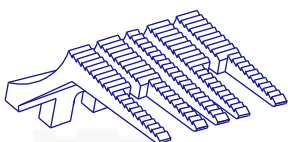

REF.	CODIGO	PULG.	/	mm.
15-431	DT20431	1/4"-1"-1/4"	→	6,35-25,5-6,35
15-432	DT20432	3/16"-1"-3/16"	→	4,76-25,4-4,76

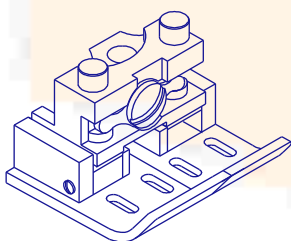

REF.	CODIGO	PULG.	/	mm.
17-431	PS20941	1/4"-1"-1/4"	→	6,35-25,5-6,35
17-432	PS20206	3/16"-1"-3/16"	→	4,76-25,4-4,76

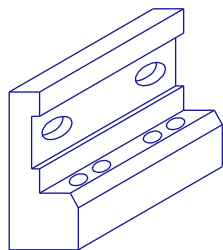

REF.	CODIGO	PULG.	/	mm.
19-429	SA20439	1/4"-1"-1/4"	→	6,35-25,5-6,35
19-430	SA20440	3/16"-1"-3/16"	→	4,76-25,4-4,76

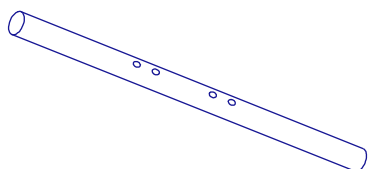

REF.	CODIGO	PULG.	/	mm.
18-431	VA20820	1/4"-1"-1/4"	→	6,35-25,5-6,35
18-432	VA20821	3/16"-1"-3/16"	→	4,76-25,4-4,76

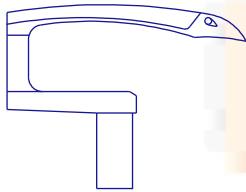

19-712
AN20401

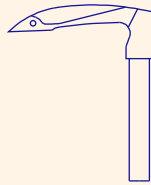

19-431
AN20941

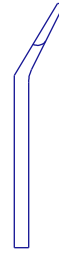

19-437
VA2040801

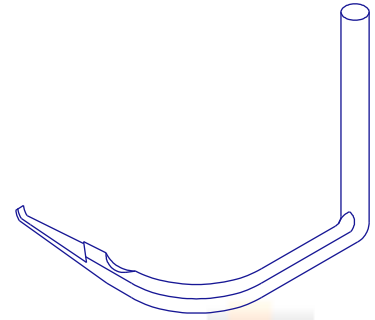

19-807
AN20402

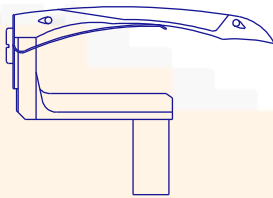

19-351
AN20101

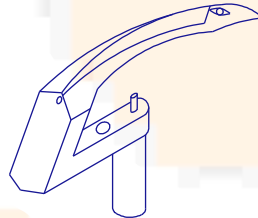

19-801
AN20403

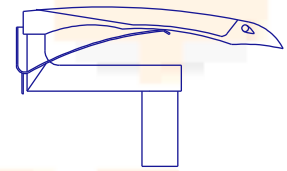

19-353
AN20102

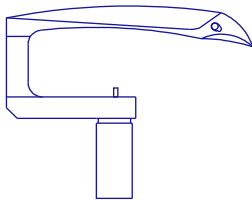

19-539
AN20105

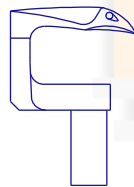

19-571
AN20103

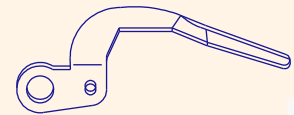

19-540
AN20104

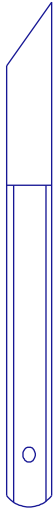

07-169
CH20201

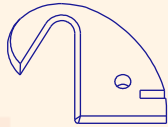

07-168
CH20202



18-719
VA2040802

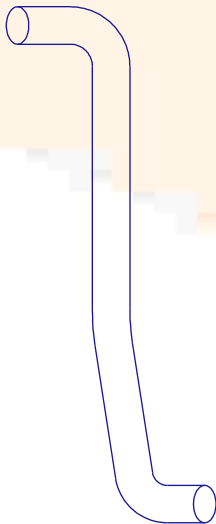

77-808
VA2010120

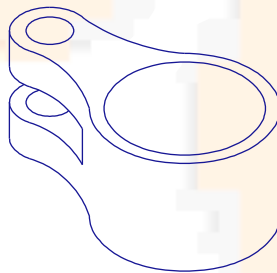

63-232
VA2094141

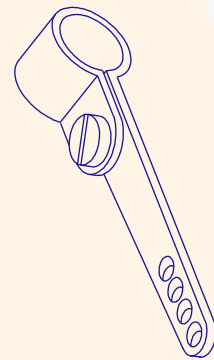

45-181
VA20408012

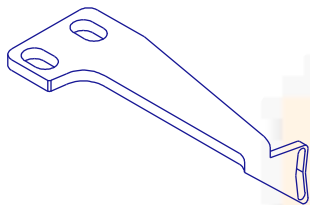

45-840
VA2010804

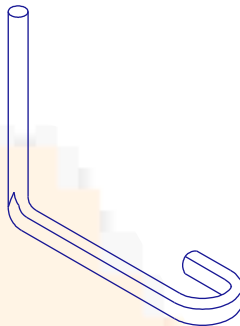

45-251
VA2010091

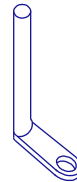

45-914
VA2010803



19-406
VA2040804

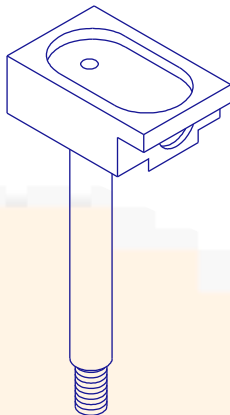

51-0130-0
VA2094142

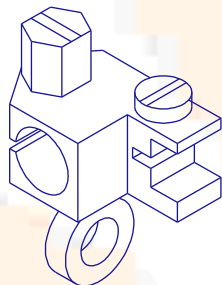

73-1210-1
VA2040807

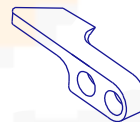

19-416
VA2040806

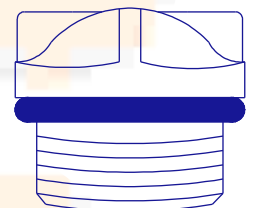

39-233
VA2010805

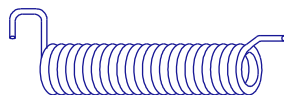

79-227
VA2010806

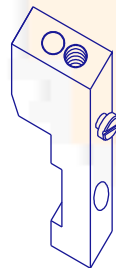

19-411
VA2040808

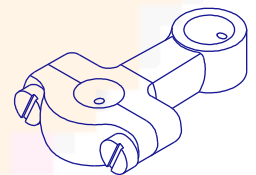

63-180
VA2010809

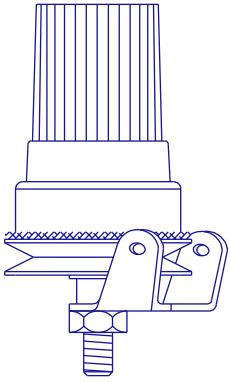

40-708
VA20807

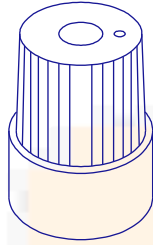

41-101
VA20810

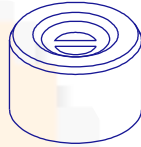

41-107
VA20825

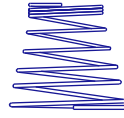

41-702
VA20806

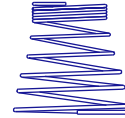

41-701
VA20823



41-721
VA2040811

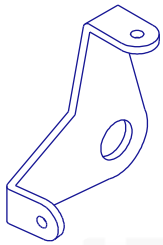

41-115
VA20824

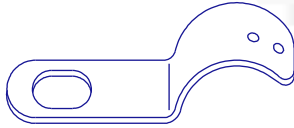

41-117
VA20822

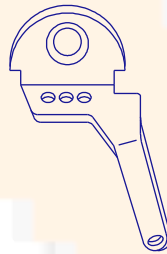

45-192
VA2040810

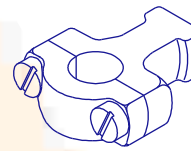

63-713
VA20108011

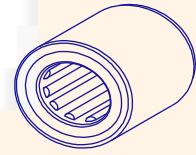

91-2670-0
VA20991

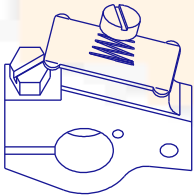

40-304
VA20809

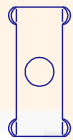

45-142
VA2040812



61-823
VA20802



61-513
VA20801



75-249
VA20408011



75-211
VA20827

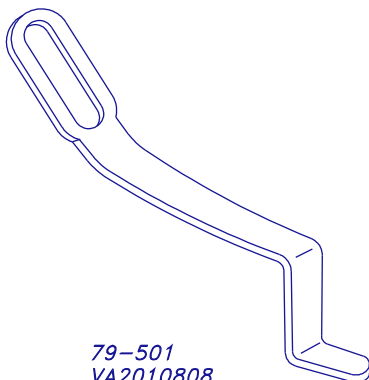

79-501
VA2010808

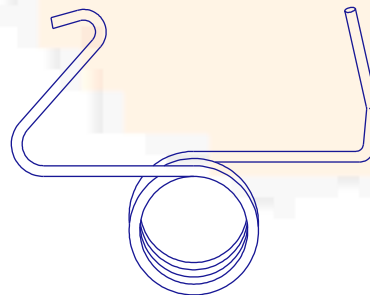

79-222
VA2010807



11-801
VA20408010

21-192
VA2040221

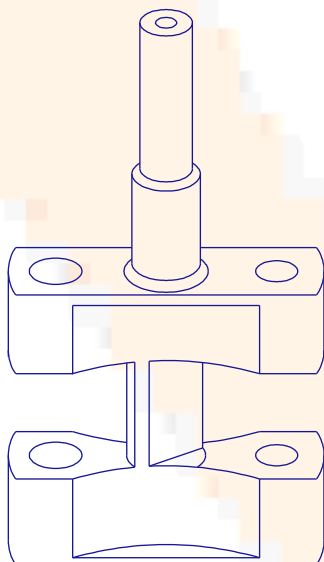
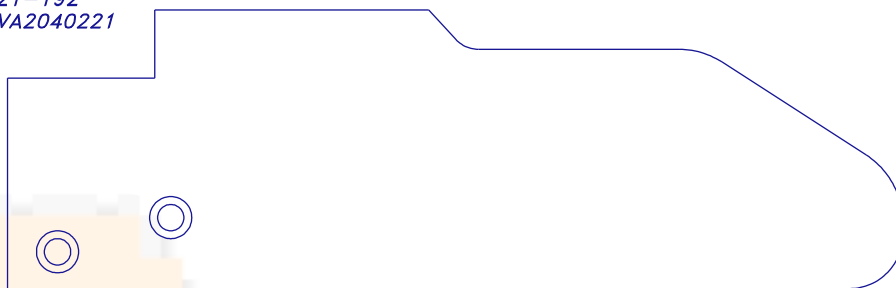

55-0410-0
VA2010051

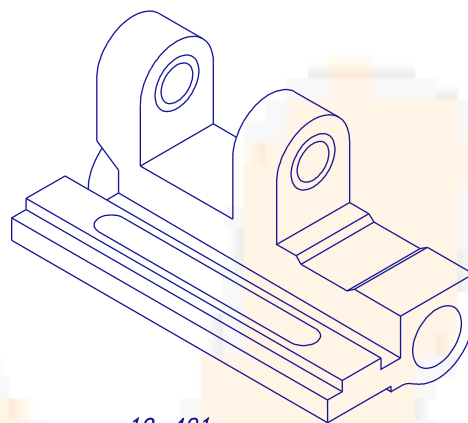

19-401
VA2094061

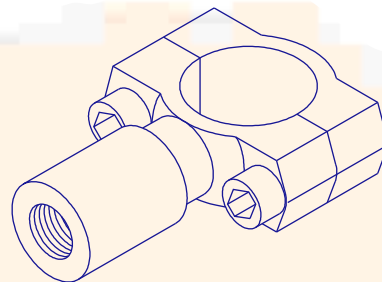

63-621
VA20108010

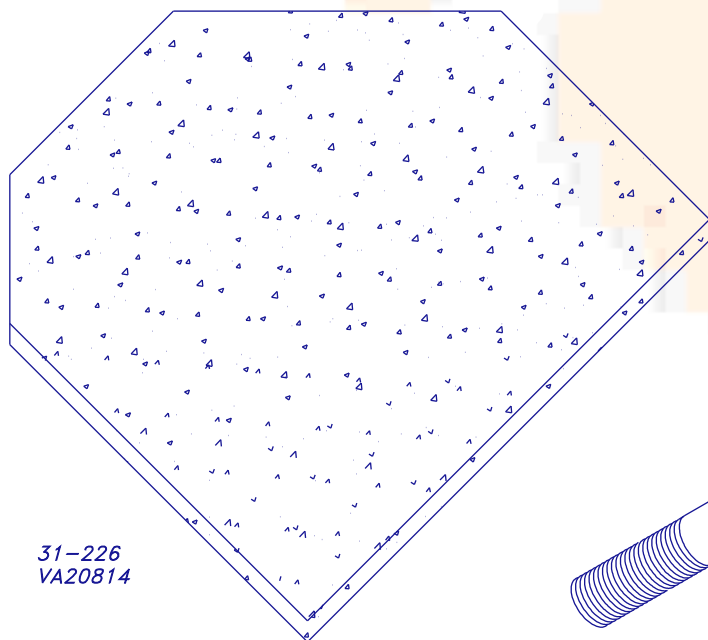

31-226
VA20814

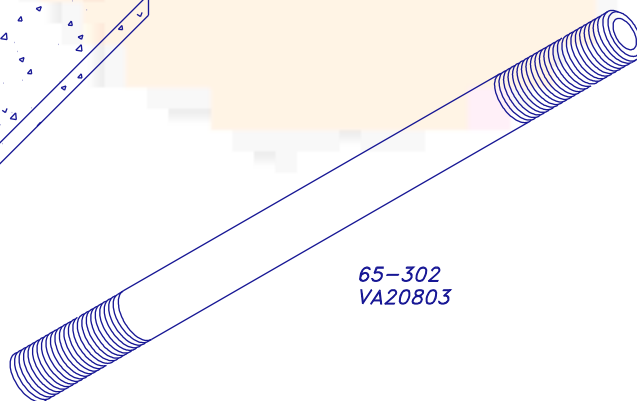

65-302
VA20803

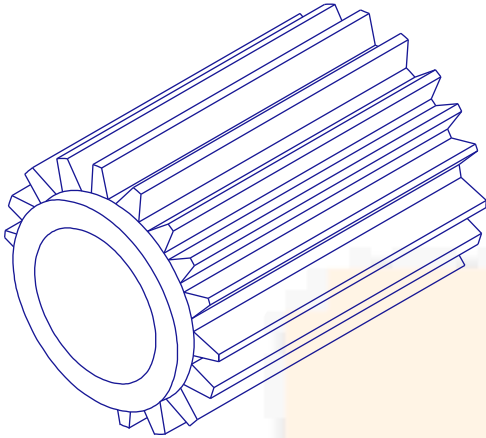

MODELO 1404-TYPE

02-1770-0 - 18 DIENTES
VA2010801

02-178 - 28 DIENTES
VA20811

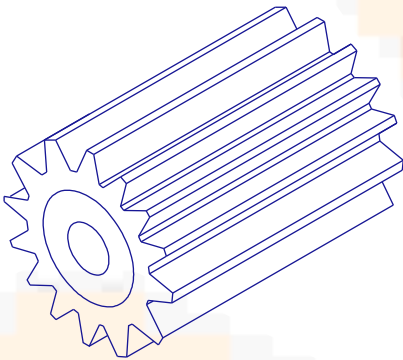

MODELO 1404-1412

02-2070-0 - 14 dientes
VA2010802

02-207 - 18 DIENTES
VA20815

02-208 - 23 DIENTES
VA20812

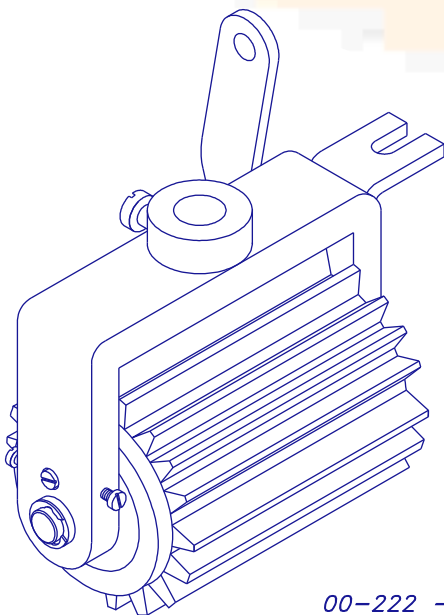

00-222 - 22 dientes
VA20829

00-228 - 28 dientes
VA20830

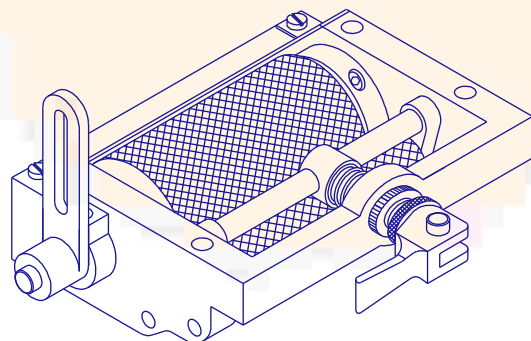

00-140
VA20831

MO-3604-OE4/MO-3614-BE6/MO-3616-DE4

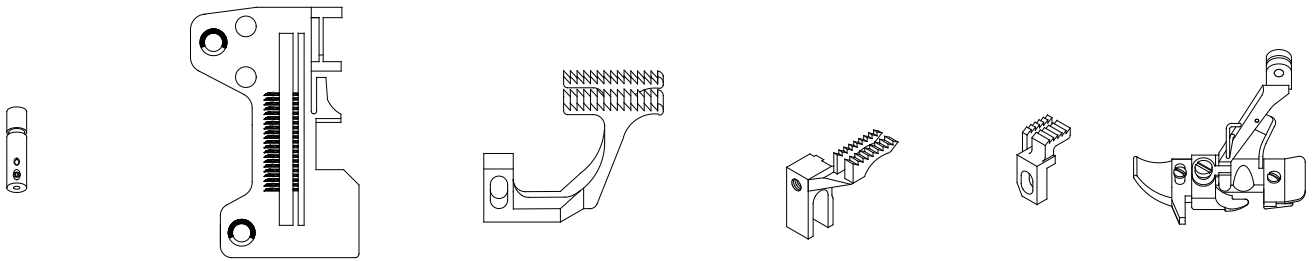

121-48607
SA17003

R4200-JOE-DAO
PA17001

B-1657-804-00T
DT17015

118-82107
DT17011

118-87106
DT17012

118-76166
PS17001

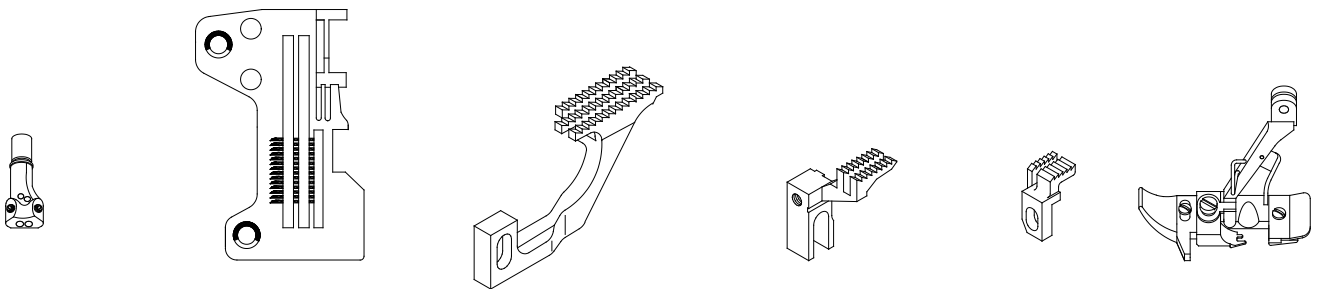

121-48706
SA17004

R4305-JOE-EAO
PA17002

119-49906
DT17001

119-49807
DT17002

118-87106
DT17012

121-52468
PS17002

OWERLOCK 2 AGUJAS 4 HILOS

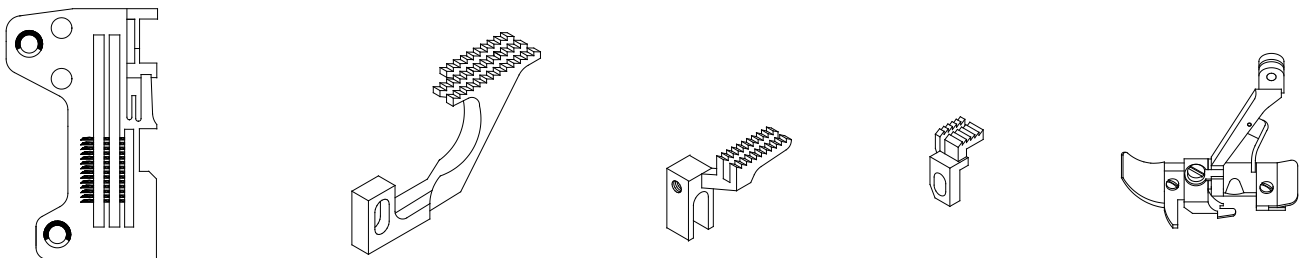

R4305-HOF-E00
PA17021

118-86504
DT17021

118-82404
DT17022

118-87403
DT17023

118-81554
PS17021

OWERLOCK 2 AGUJAS 4 HILOS

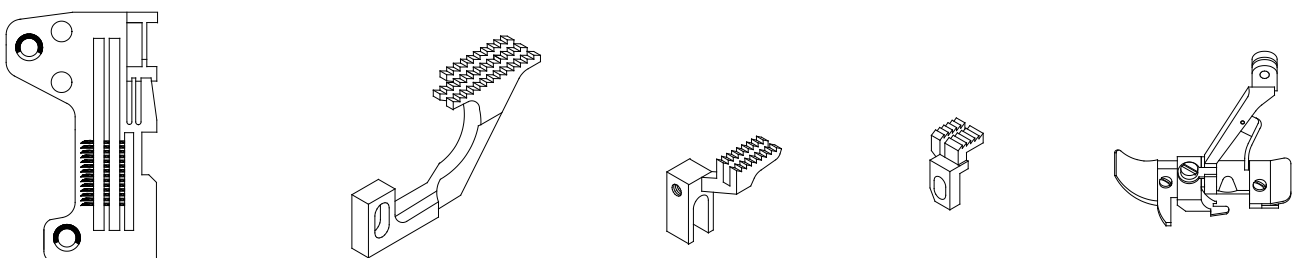

R4308-HOF-E00
PA17022

117-90706
DT17024

118-82503
DT17025

118-87205
DT17026

118-77156
PS17022



MO-3304E-OE4/MO-3314E-BE6/MO-3316E-DE4

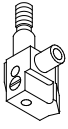

124-65001
SA17005

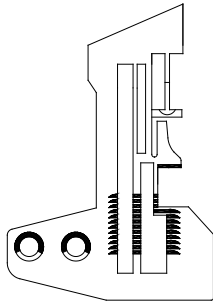

R4200-LOE-E00
PA17003

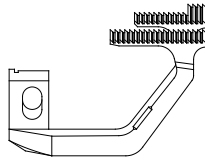

124-78004
DT17003

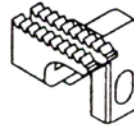

124-76008
DT17005



124-80000
DT17007

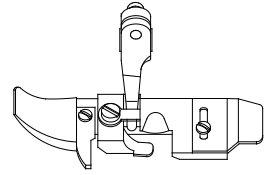

124-66058
PS17003

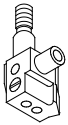

124-65100
SA17006

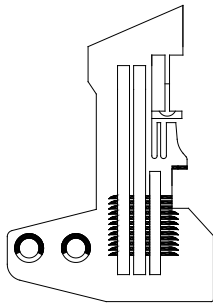

R4305-LOE-E00
PA17018

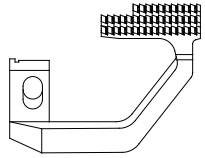

124-78103
DT17004

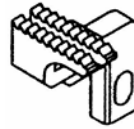

124-76107
DT17006



124-80109
DT17008

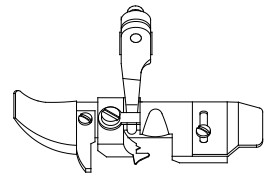

124-66553
PS17004



B2402-771-000
PA17020

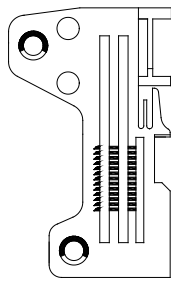

R4305-HOD-EOA
PA17019



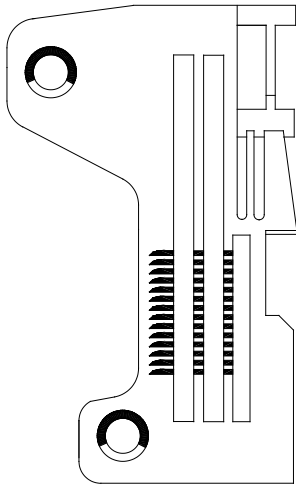

*R4305-HOD-EAB
PA17023*

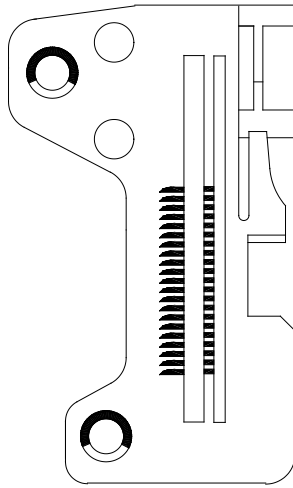

*R4200-HOD-DA0
PA17013*

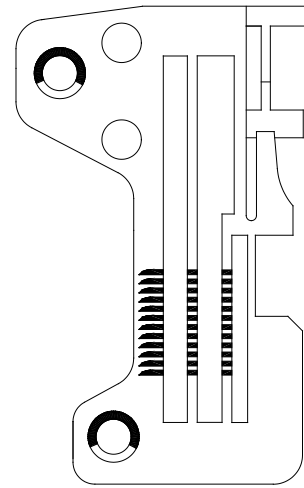

*R4300-HOD-E00
PA17014*

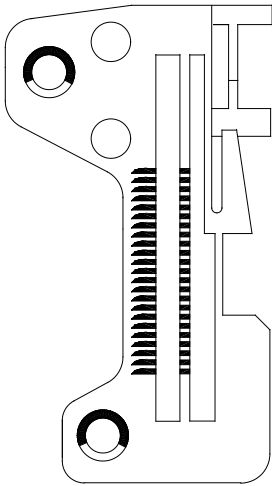

*R4200-HOD-DOE
PA17011*

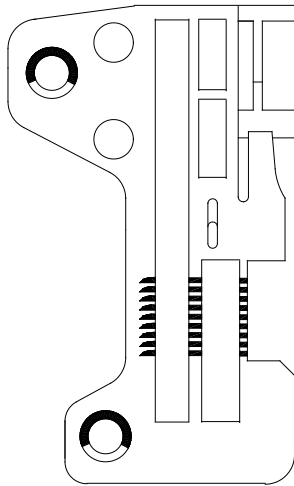

*R4508-HOD-D00
PA17012*

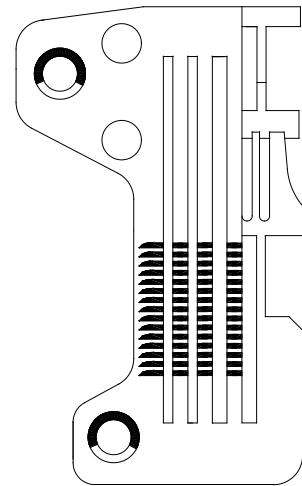

*R4405-HOD-E00
PA17024*

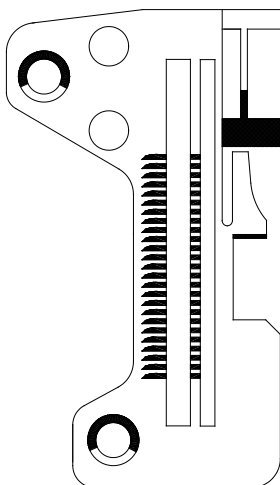

*R4200-HOD-D00
PA17015*

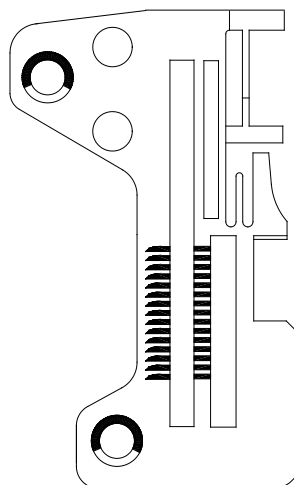

*R4205-HOD-E00
PA17025*

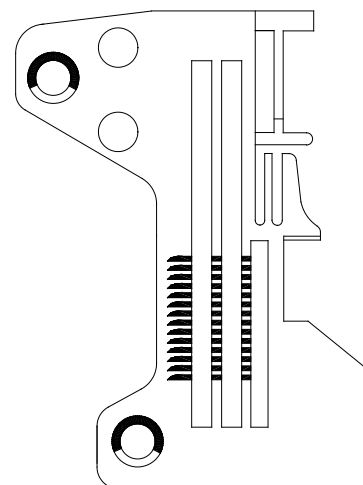

*R4305-JOD-E00
PA17026*



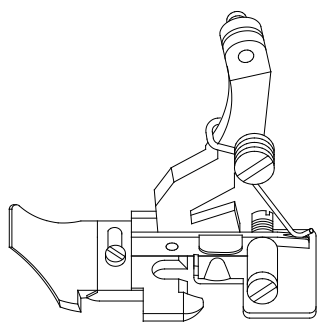

118-7752
PS17023

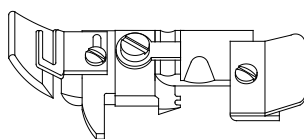

118-79251
PS17024

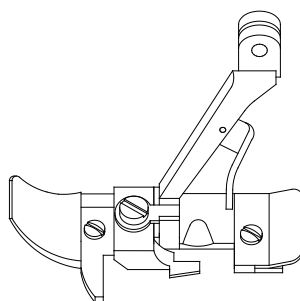

118-81455
PS17010

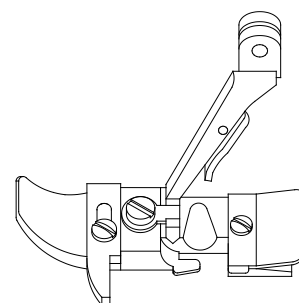

118-76356
PS17014

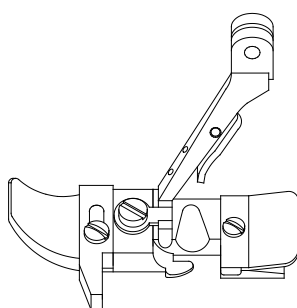

118-76158
PS17015

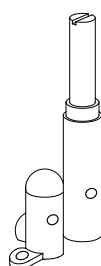

118-70359
SA17021

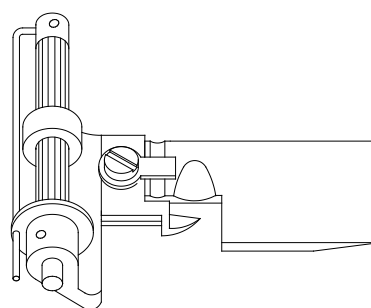

PS17012/2 - Prensateles 1 aguja rodillo 10 mm.

PS17012 - Prensateles 1 aguja rodillo 30 mm.

PS17012/1 - Prensateles 1 aguja rodillo 45 mm.

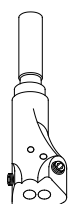

118-69658
SA17022

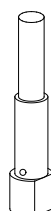

118-69005
SA17010

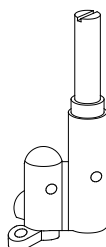

118-70458
SA17020

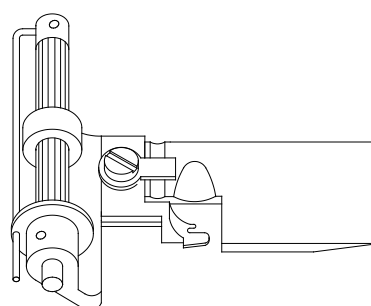

PS17013/2 - Prensateles 2 agujas rodillo 10 mm.

PS17013 - Prensateles 2 agujas rodillo 30 mm.

PS17013/1 - Prensateles 2 agujas rodillo 45 mm.

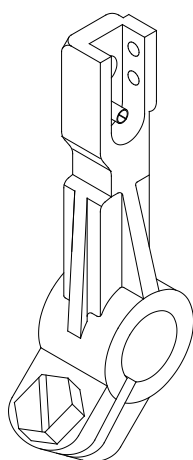

118-32458
SA17001

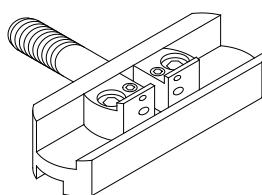

212W-ANC
SA17002

**SOPORTE AGUJAS
GRADUABLE DE REPUNTE**

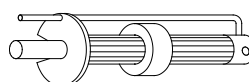

VA40410124 → 10 mm

VA40410121 → 30 mm

VA40410122 → 45 mm



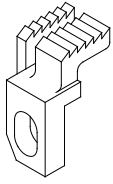

118-87106
DT17012

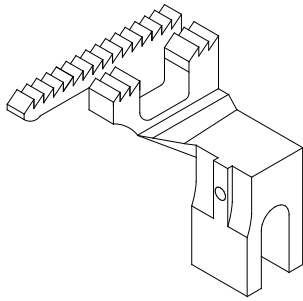

118-82800
DT17010

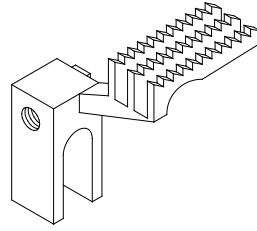

118-835
DT17027

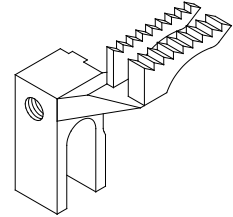

118-82107
DT17011

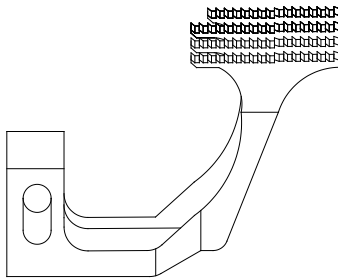

M814BF
DT17028

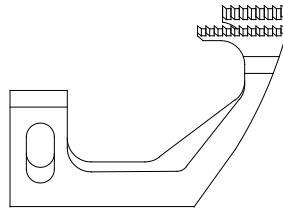

118-85209
DT17013

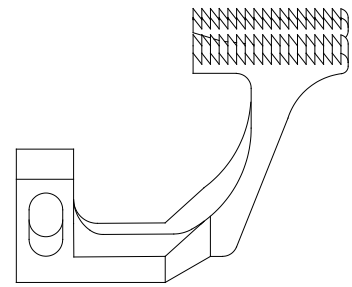

B-1657-804-00T
DT17015

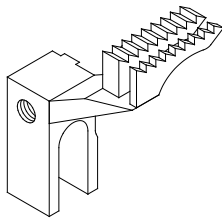

118-82206
DT17029

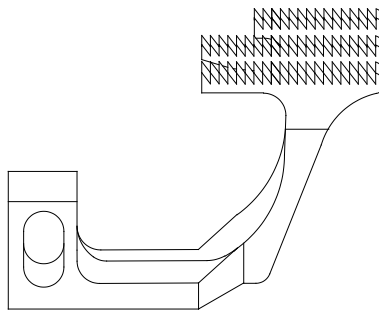

118-85100
DT17030

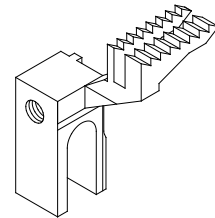

115-97101
DT17016



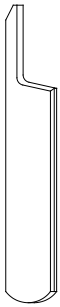

B-4108-352-00B
CH17006

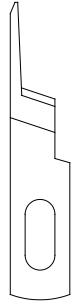

118-45708
CH170011



B-4122-352-00A
CH17007

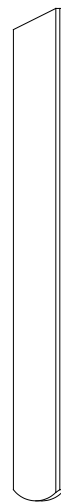

118-46003
CH17008

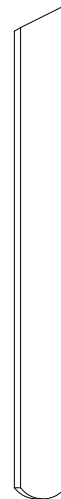

B-4118-804-000
CH17009

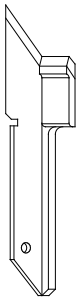

B-4111-804-00C
CH17001

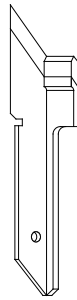

118-45906
CH17004



118-45807
CH17002

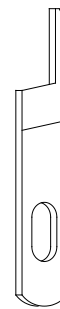

118-45609
CH17005

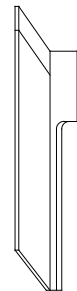

B-4111-804-00A
CH17003

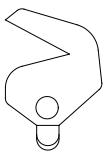

B-1528-804-000A
CH170013

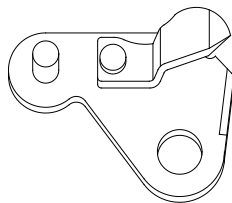

B-2406-373-0A0
CH17011

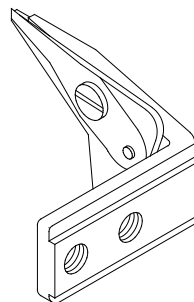

B-2001-771-0A0
CH17101

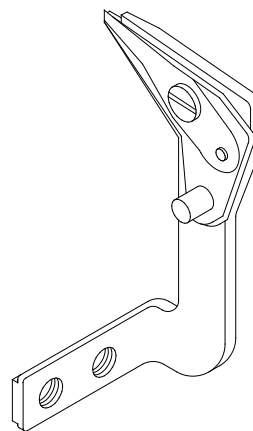

2001762
VA1710801

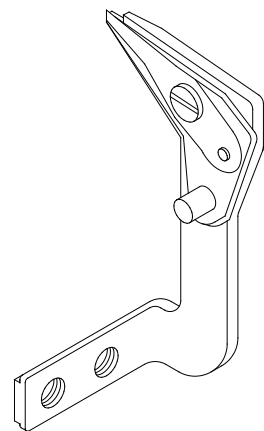

B-2001-762-0A0
CH17010



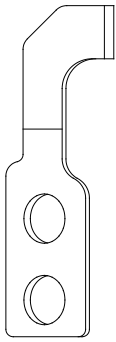

B-2410-373-000
CH170010

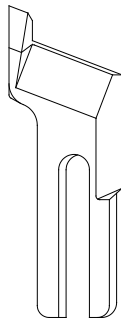

B4121-052-A00
CH17401

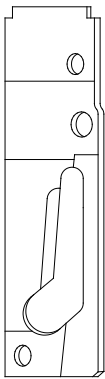

BM926753
CH17937

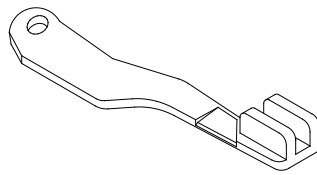

BM900
CH17935

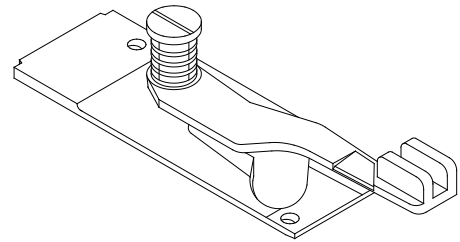

BM899
CH17936

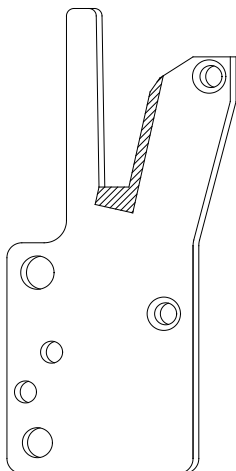

MAT02204
CH17012



B2003-771-000
VA179218



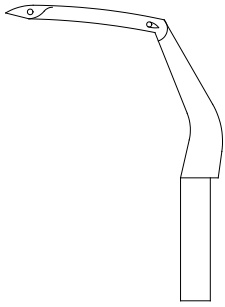

118-29405
AN17003

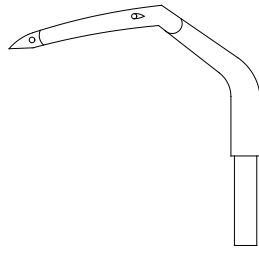

B2118-816-000
AN17004

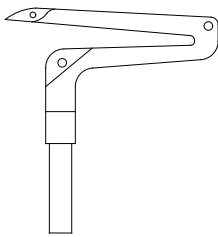

B2521-804-000
AN17002

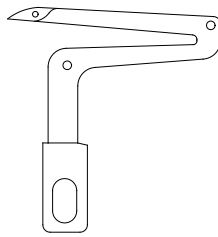

118-88401
AN17001



B-1239-372-000
AN17931



118-88104
AN17008

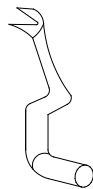

118-88609
AN17007



B2514-803-000
AN17009

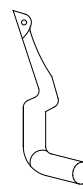

118-88302
AN17006



B2519-804-000
AN17005

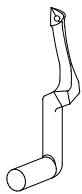

118-88005
AN17010



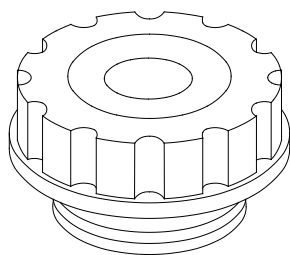

118-00604
VA1700802

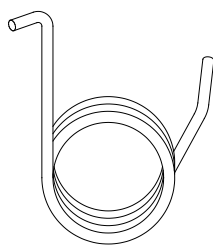

118-02006
VA1700803

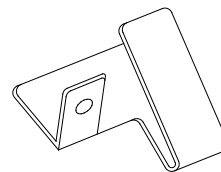

118-00901
VA1700805



118-16303
VA1700806

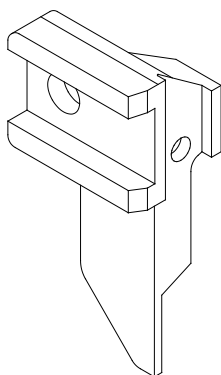

118-45302
VA1700804

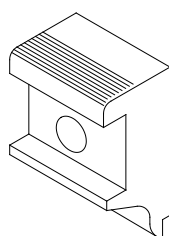

118-45500
VA17012

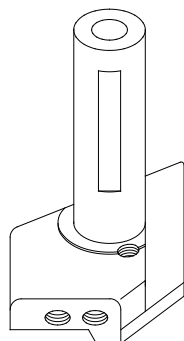

118-46201
VA17015

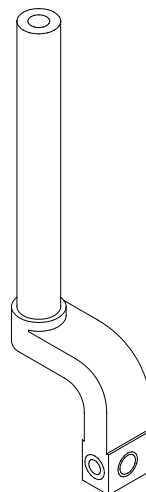

115-21002
VA1700111

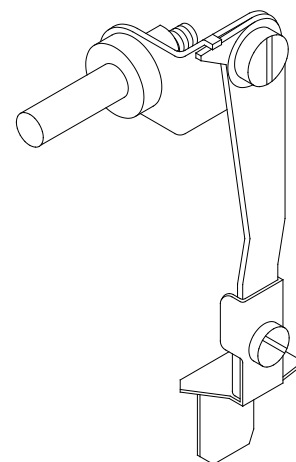

MAT-80103-HAO
VA17001

TENSOR OWERLOCK JUKI

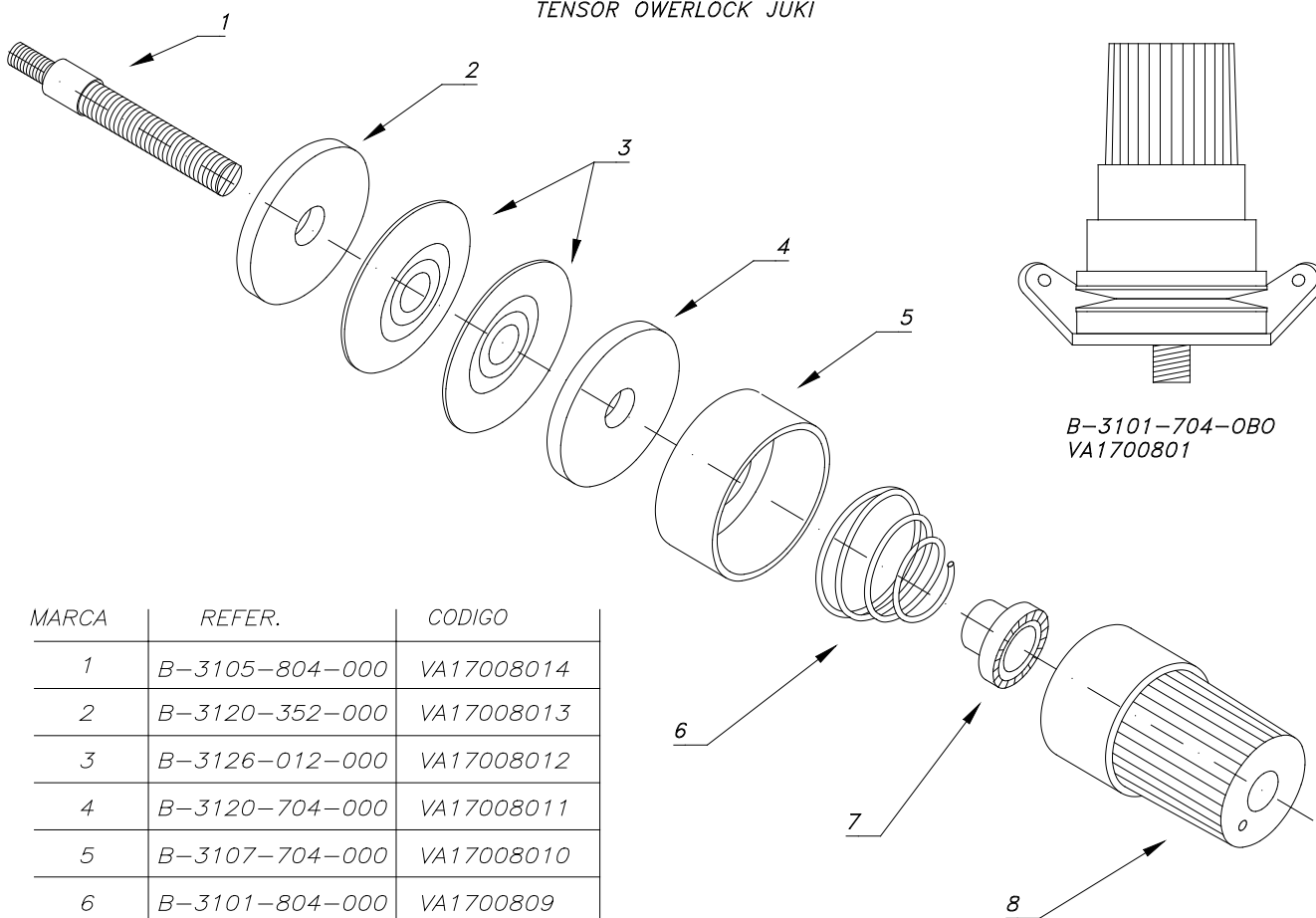

B-3101-704-0B0
VA1700801

MARCA	REFER.	CODIGO
1	B-3105-804-000	VA17008014
2	B-3120-352-000	VA17008013
3	B-3126-012-000	VA17008012
4	B-3120-704-000	VA17008011
5	B-3107-704-000	VA17008010
6	B-3101-804-000	VA17008009
7	B-3112-704-000	VA17008008
8	B-3106-704-00A	VA17008007



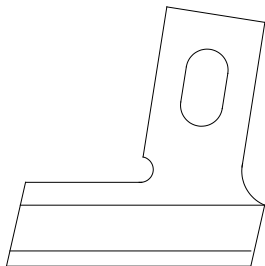

MEDIDA	REFERENCIA	CODIGO
1/4"	B-2702-047-F00	CH17925
5/16"	23444	CH17929
3/8"	B-2702-047-K00	CH17923
7/16"	23446	CH17928
1/2"	B-2702-047-L00	CH17924
9/16"	B-2702-047-V00	CH17927
5/8"	B-2702-047-M00	CH17930
11/16"	23450	CH17931
3/4"	B-2702-047-N00	CH17933
7/8"	B-2702-047-P00	CH17934
1"	B-2702-047-Q00	CH17921
1 1/8"	B-2702-047-R00	CH17932
1 1/4"	B-2702-047-S00	CH17922

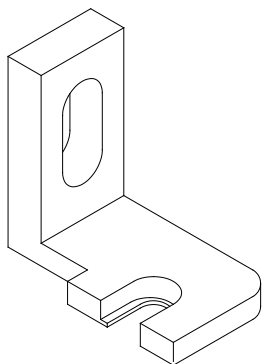

B2419-372-B00 6mm
VA17013

B2419-372-A00 5mm
VA17014

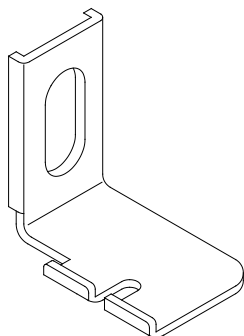

B-2408-372-000
VA17938013

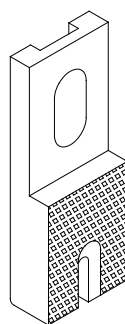

B-2410-372-00A
VA17009

B-2410-372-00B
VA17020

B-2410-372-00C
VA17021

B-2410-372-00D
VA17022

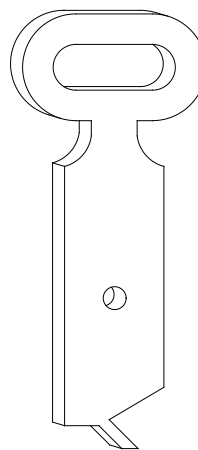

B-1237-372-000
VA17938006

B-1237-373-000
VA17938016



B-3104-372-000
VA17990802

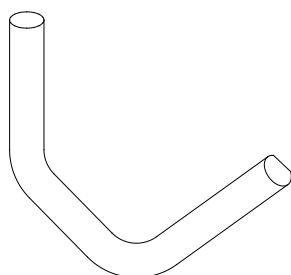

B-2546-372-000
VA17938002

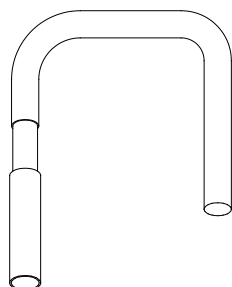

110-42652
VA179227

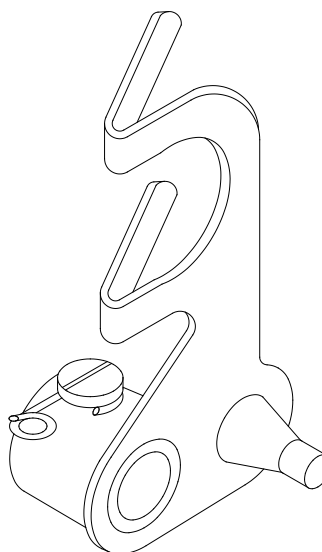

B-2025-372-0A0
VA179229

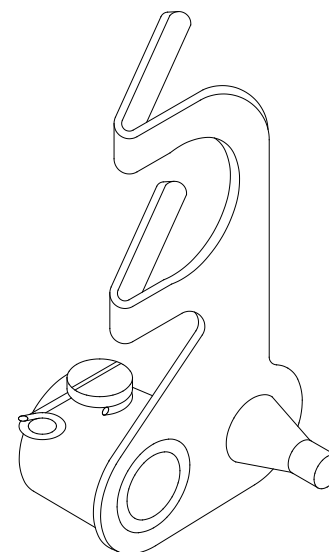

B-2025-372-0H0
VA17938005



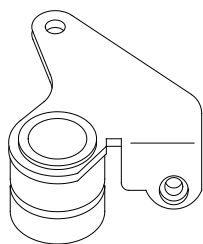

B-2031-372-0A0
VA17938010

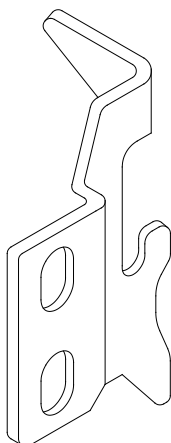

B-1807-771-000
VA179211

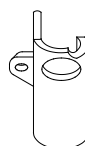

B-1451-771-00A
VA179201

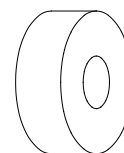

B-2607-372-000
VA17938008

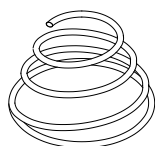

B-3114-232-000
VA17938011

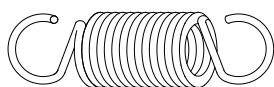

B-2008-372-000
VA17990801

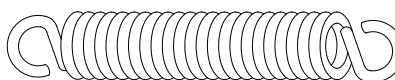

B-2609-372-000
VA17938007

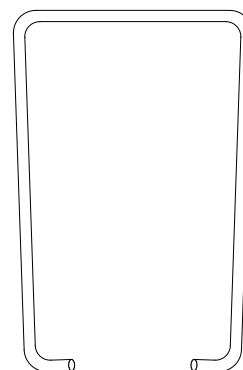

B-2561-372-000
VA17938009

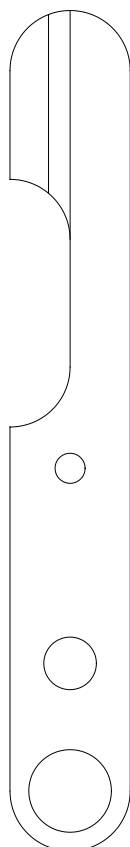

B-2611-372-000
VA1793801

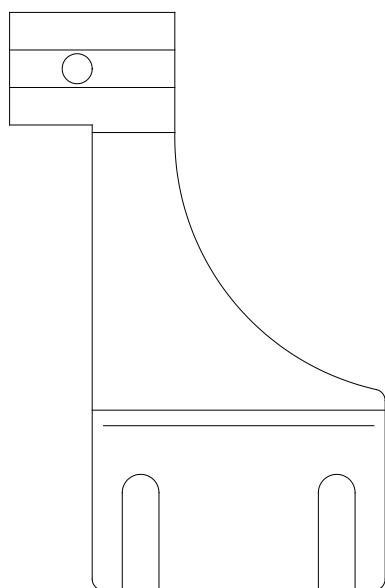

B-2409-372-000
VA17938004

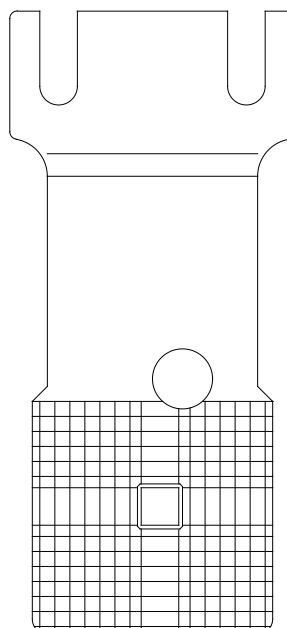

B-2529-372-000
VA17938003

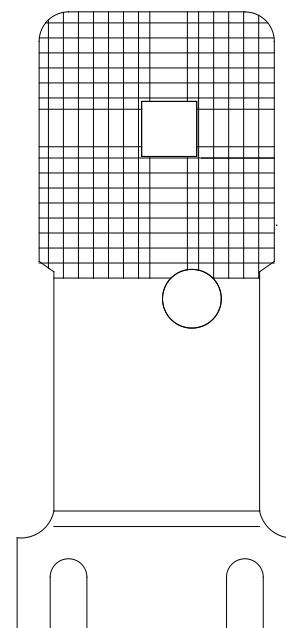

B-2529-373-000
VA17938001



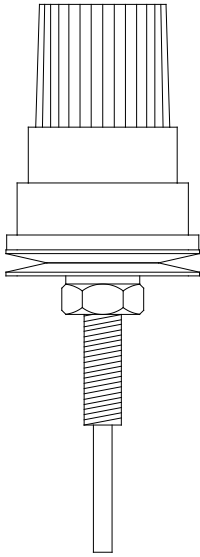

*B-3103-771-OAO
VA179231*



*NS-6110310-SP
VA17990805*

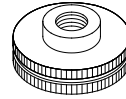

*B3216-047-000
VA17990804*

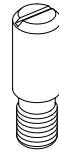

*B2615-372-000
VA179225*

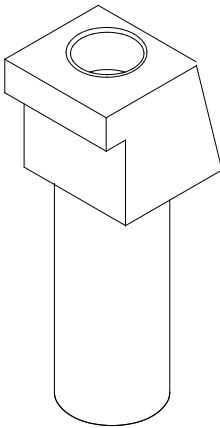

*B-2604-372-000
VA17938014*



*B-2543-372-000
VA17010*

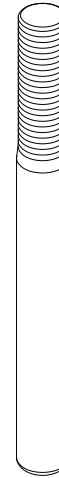
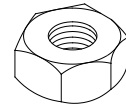

*B2543-372-OAO
VA179214*

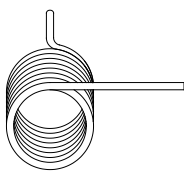

*B2404-372-000
VA179202*

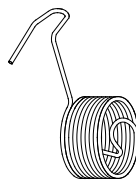

*B-3112-761-000
VA17938015*

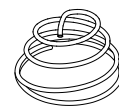

*B3218-232-000
VA17990803*



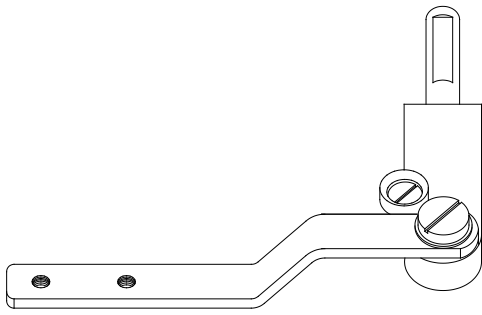

VA1700081

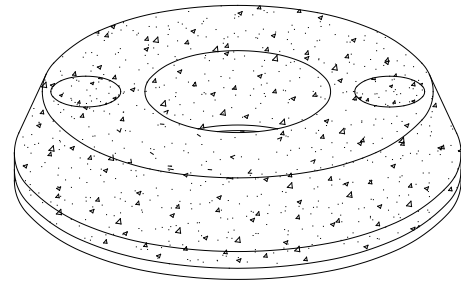

B1208-372-000
VA17938017

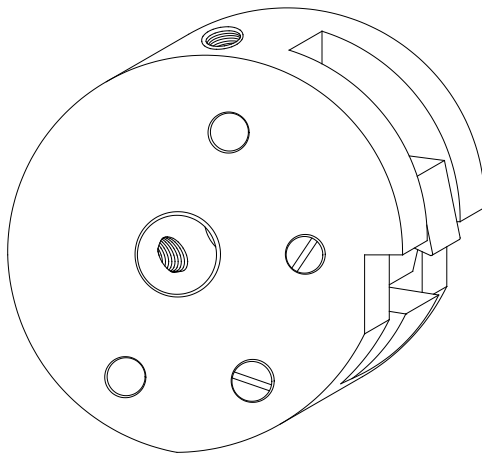

B1210-372-0A
VA179217

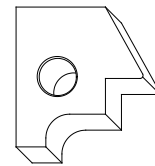

B1211-372-000
VA179213

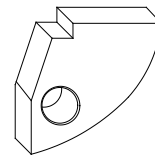

B1212-372-000
VA179212

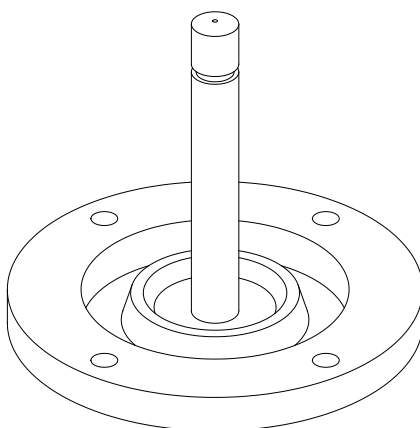

B-7160-781-0A0
VA17006

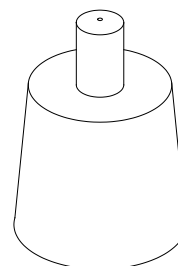

B-8209-804-000
VA179226



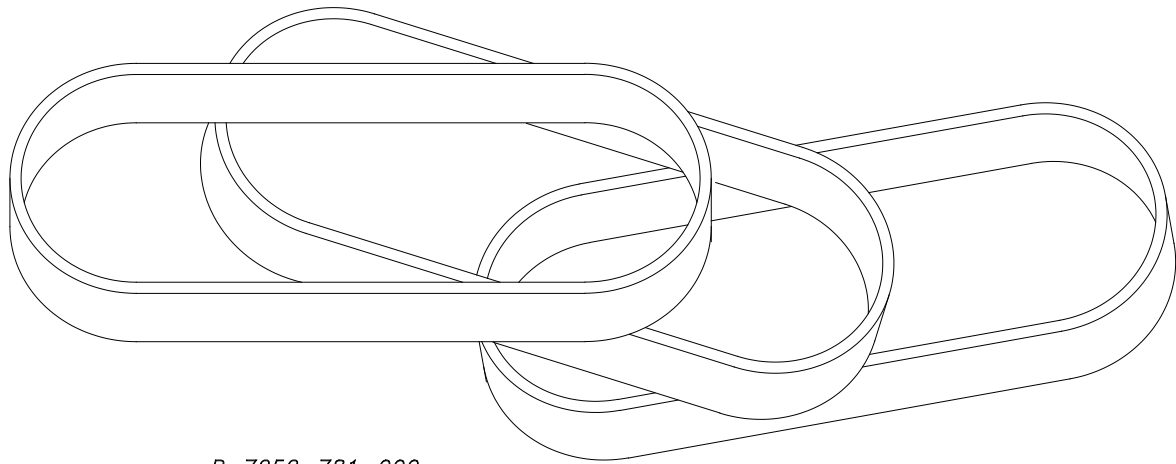

B-7252-781-000
VA179228

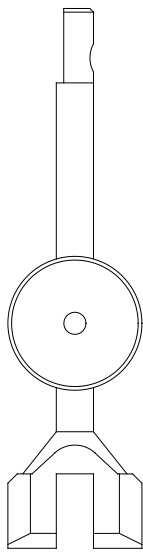

B-2517-804-0A0
VA17005

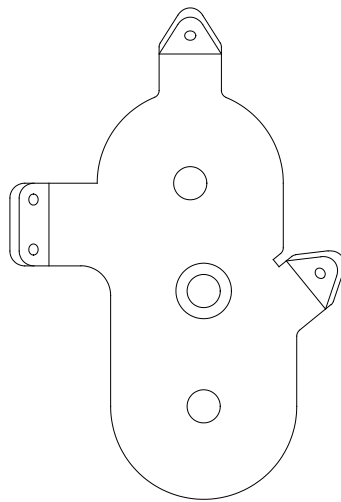

118-36301
VA179221

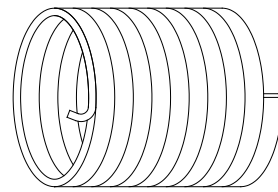

B2914-761-000
VA179223

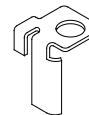

B2429-771-000
VA17008



118-90001
VA17007

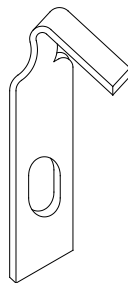

B-1242-373-000
VA179230

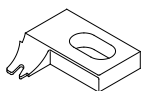

B1509-814-00P
VA179224

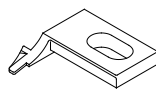

118-74609
VA179233



B1508-804-00B
VA179222

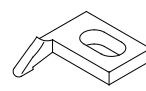

B1509-804-000
VA179232





JUEGO DE OWERLOCK 1 AGUJA

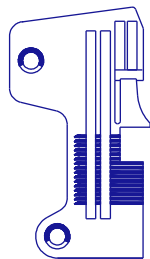

146733-0-01
PA15012

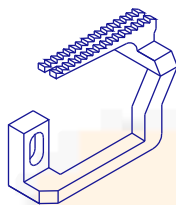

146748-0-01
DT15007

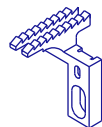

146744-0-01
DT15005



146577-0-01
DT15006

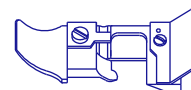

146884-0-01
PS15012

OWERLOCK 1 AGUJA 3 HILOS

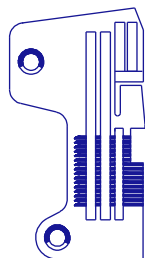

146736-0-01
PA15011

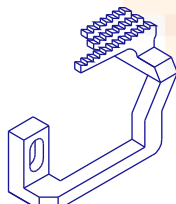

146750-0-01
DT15001

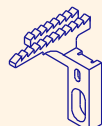

146745-0-01
DT15002



146578-0-01
DT15003



146898-0-01
PS15011

OWERLOCK 2 AGUJAS 4 HILOS

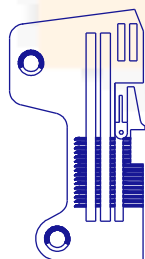

146782-0-01
PA15021

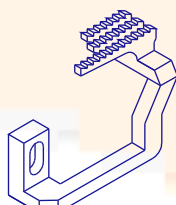

146750-0-01
DT15001



146745-0-01
DT15002



146578-0-01
DT15003



146904-0-01
PS15021

JUEGO DE OWERLOCK 2 AGUJAS

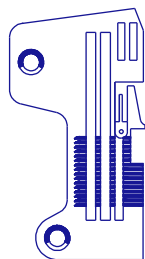

146781-0-01
PA15022

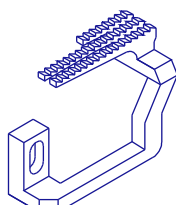

146749-0-01
DT15004

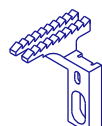

146744-0-01
DT15005



146577-0-01
DT15006

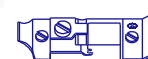

146902-0-01
PS15022



JUEGO DE OWERLOCK 5 HILOS

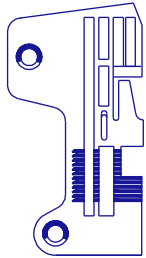

146503-001
PA15023

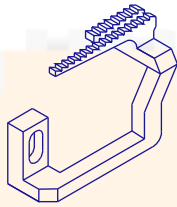

146572-001
DT15021

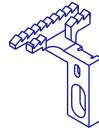

146567-001
DT15022



146577-0-01
DT15006

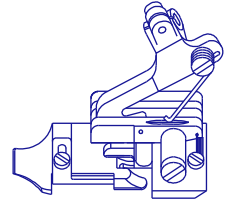

146871-001
PS15023

JUEGO DE OWERLOCK 5 HILOS

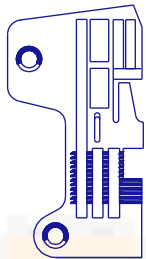

146504-001
PA15025

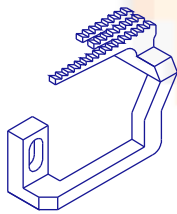

146573-001
DT15010

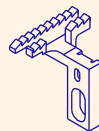

146568-001
DT15011



146577-0-01
DT15006

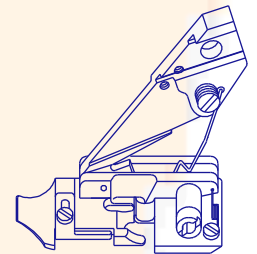

146874-001
PS15024

JUEGO DE OWERLOCK 5 HILOS

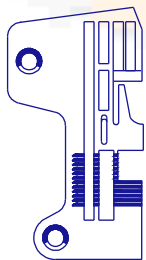

146501-001
PA15024

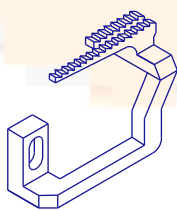

146572-001
DT15021

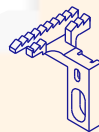

146567-001
DT15022



146577-0-01
DT15006

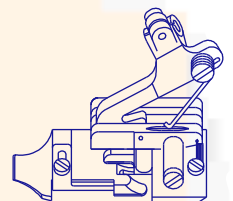

156062-0-01
PS15020

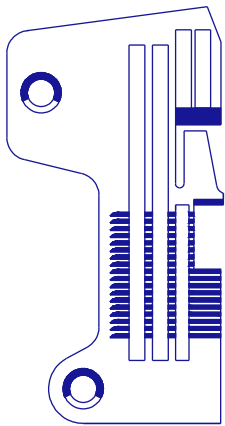

146734-0-01
PA15013

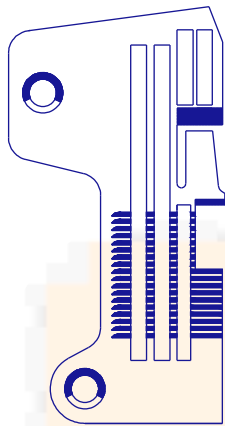

146735-0-01
PA15026

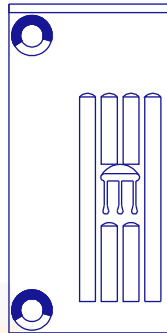

S08723
PA15027

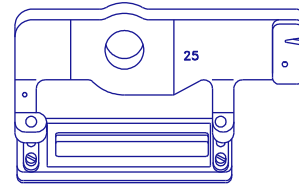

150764-0-01
PS15015

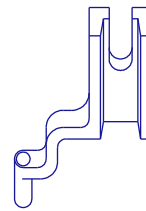

152283-0-01
PS15025

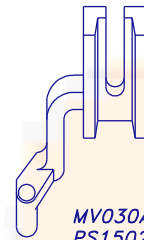

MV030A256
PS15026

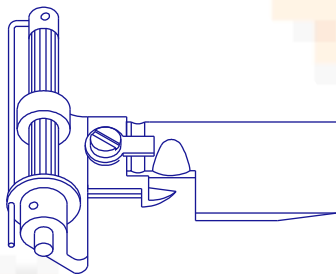

PS15013/2 - Prensatelas 1 aguja rodillo 10 mm.

PS15013 - Prensatelas 1 aguja rodillo 30 mm.

PS15013/1 - Prensatelas 1 aguja rodillo 45 mm.

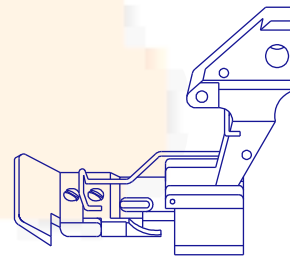

142258-0-01
PS15051

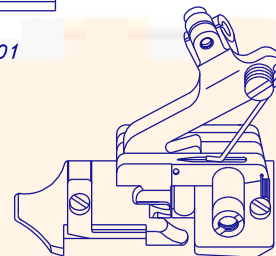

156062-0-01
PS15020

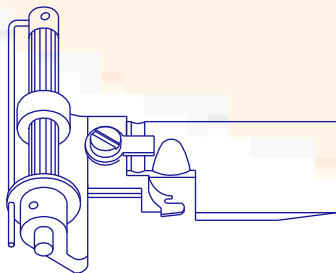

PS15014/2 - Prensatelas 2 agujas rodillo 10 mm.

PS15014 - Prensatelas 2 agujas rodillo 30 mm.

PS15014/1 - Prensatelas 2 agujas rodillo 45 mm.

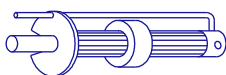

VA40410124 → 10 mm
VA40410121 → 30 mm
VA40410122 → 45 mm

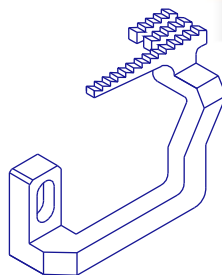

146574-0-01
DT15012

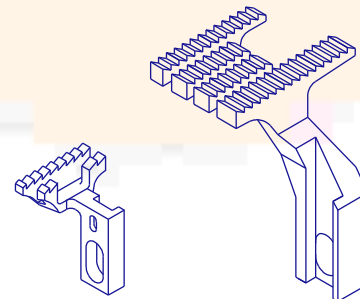

146569-0-01
DT15013

S08883-0-01
DT15008

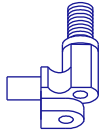

154916-001
SA15024

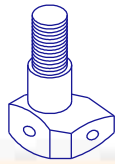

146773-0-01
SA15021

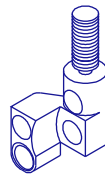

146489-001
SA15022

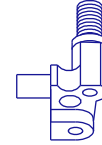

154918-001
SA15023

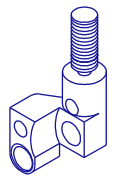

146491-001
SA15025

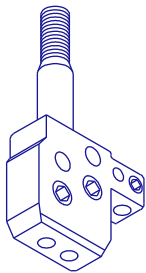

S08701-0-01
SA15026

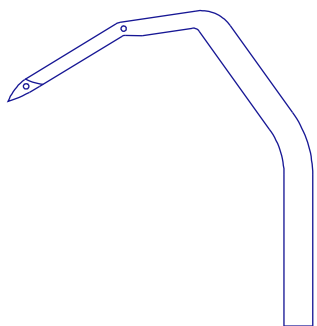

146635-0-01
AN15002

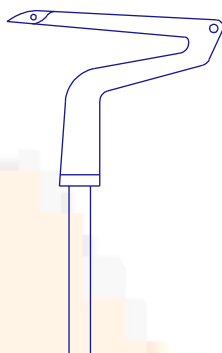

144049-0-01
AN15001



110121-0-01
AN15004

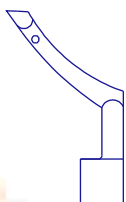

147936-0-01
AN15003

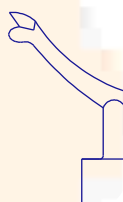

147935-001
AN15005



147934-0-01
AN15006

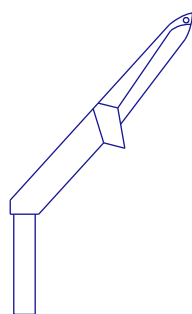

143733-001
AN15007

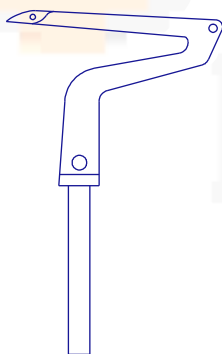

143734-0-01
AN15008



115069-0-01
AN15931

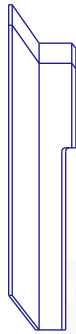

140568-001
CH15001

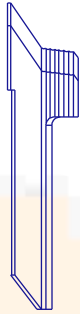

148815-001
CH15002

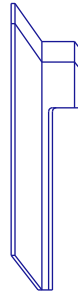

140242-001
CH15003



140567-001
CH15004

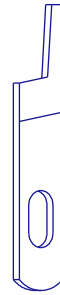

144074-001
CH15005

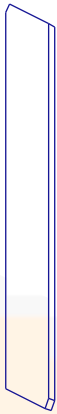

118527-0-01
CH150010



112436-001
CH15007



114077-001
CH15006

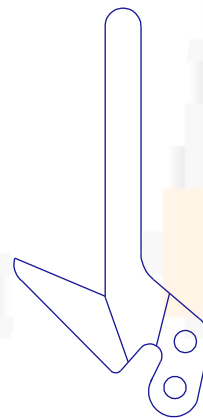

140888-0-01
CH15009

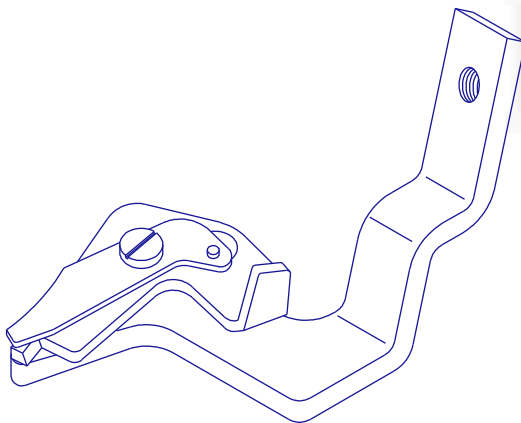

141509-0-001
CH150011

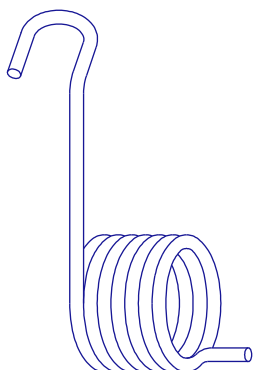

143325-001
VA1599803



146726-0-01
VA150801

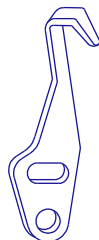

144127-0-01
VA150061



147631-001
TN15091



146483-0-01
VA1599801



146886-0-01
VA150813

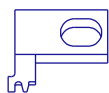

146903-0-01
VA1502121



146887-0-01
VA150121

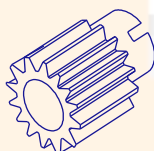

144619-000
VA1599802

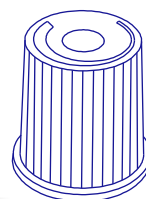

149568-004
VA1599805

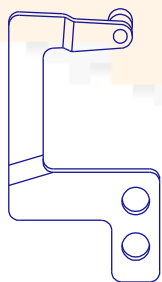

142416-0-01
VA150803

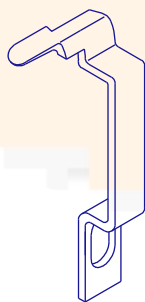

146777-0-01
VA1500802

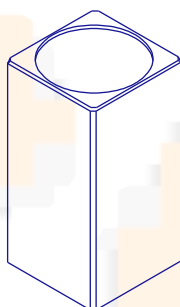

146544-000
VA1500806

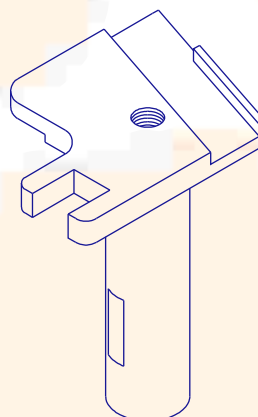

146754-001
VA150802



117515-001
VA150811

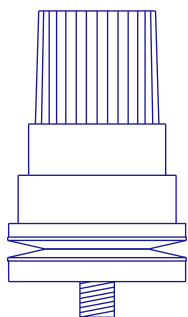

110821-0-01
VA1500803

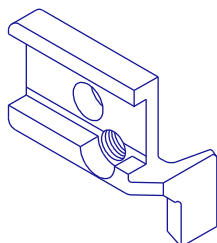

148341-001
VA1599804

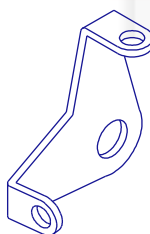

110813-0-01
VA1500804



146662-001
VA150807



146870-001
VA150809

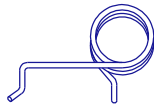

146869-001
VA150808

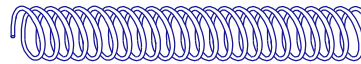

144086-001
VA150810

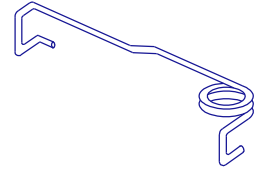

142246-001
VA150806

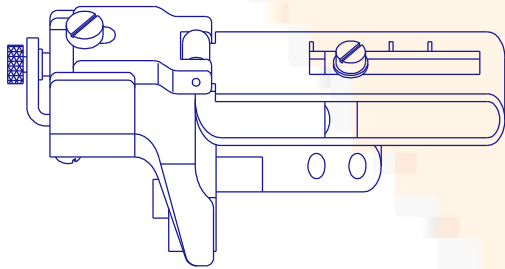

147710-0-01
VA150805

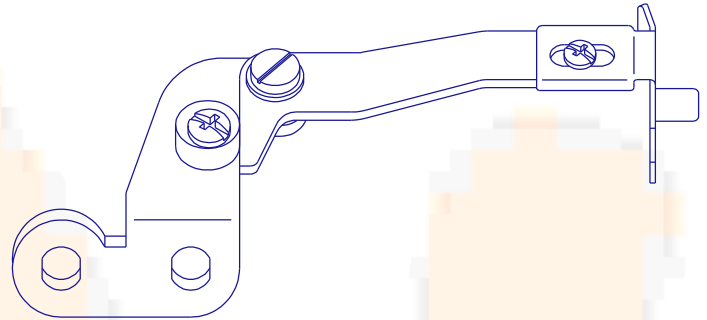

146761-001
VA1500807

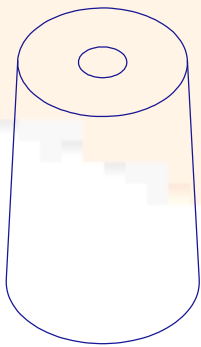

147919-0-01
VA150812



142686-001
VA150067

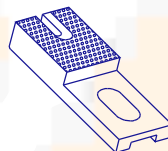

142687-001
VA150066



142688-001
VA150068

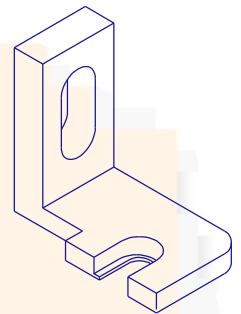

142678-001
VA150814

S03641-001
VA150065



R0439/1
VA1500081

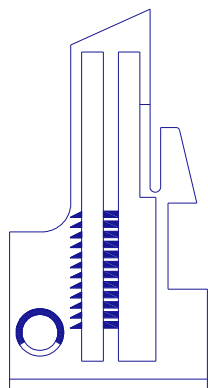

32672
PA22012

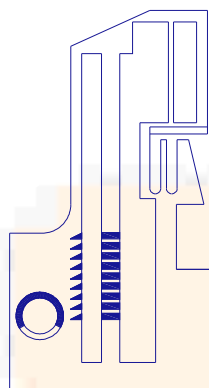

34604
PA22021

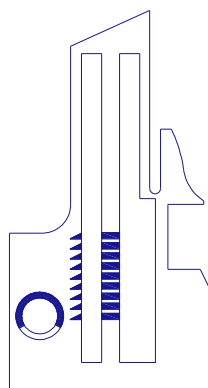

34564
PA22011

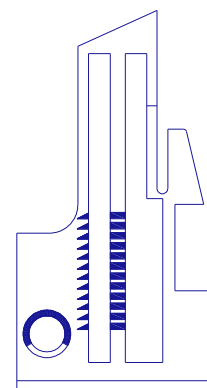

Y32673
PA22013

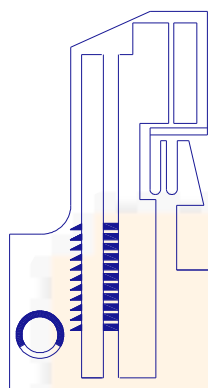

32340
PA22022

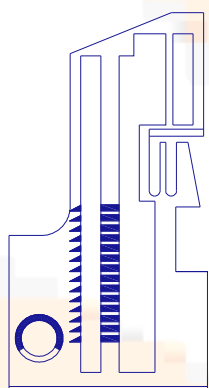

33821
PA22015

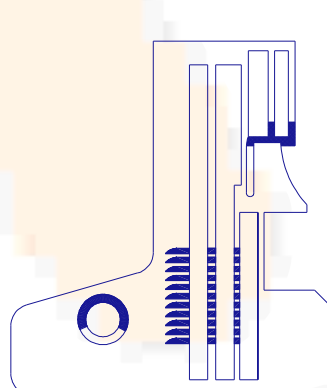

Y2118007
PA22014

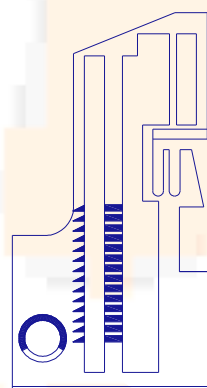

34600
PA22020

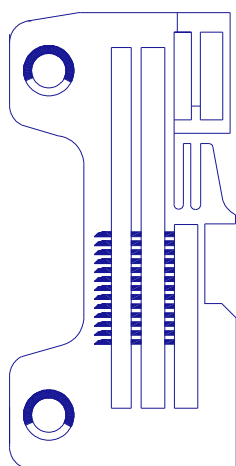

2108005
PA220216

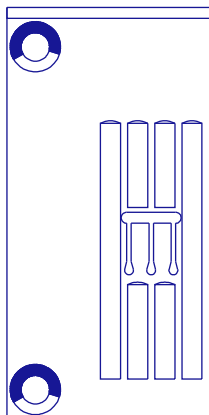

90553 7/32"
PA22431
94801 7/32"
PA22432

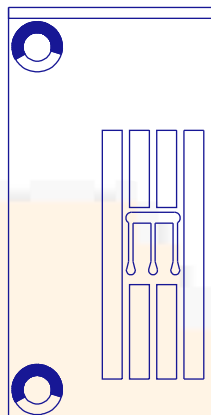

90166 7/32"
PA22434

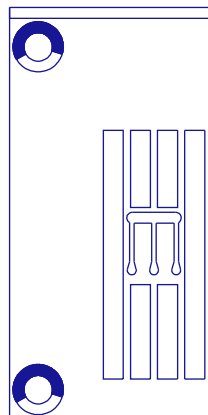

94802 1/4"
PA22433

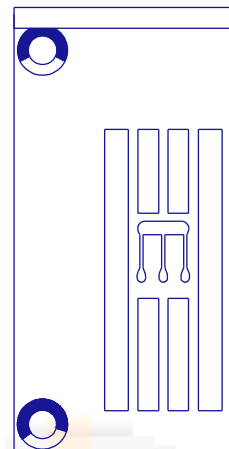

90167
PA22435

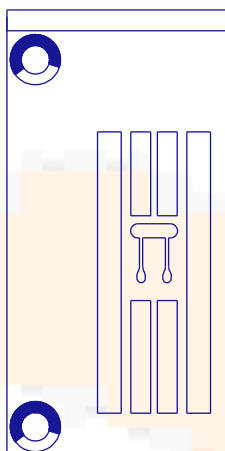

93170
PA22023

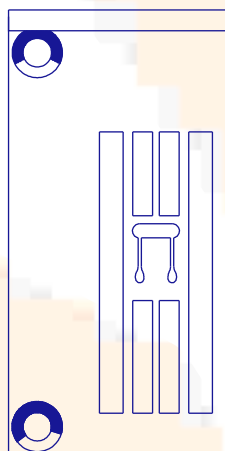

93171
PA22424

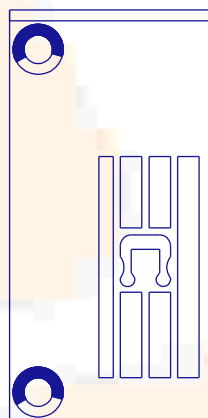

93172 3/16"
PA22421

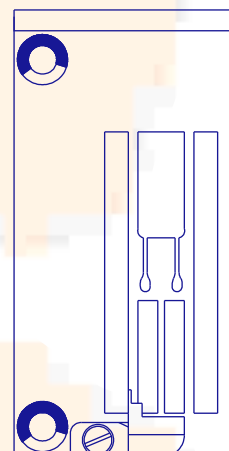

94962
PA22024

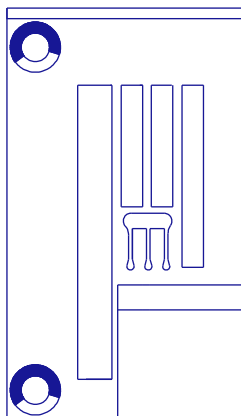

94902 1/4"
PA22331

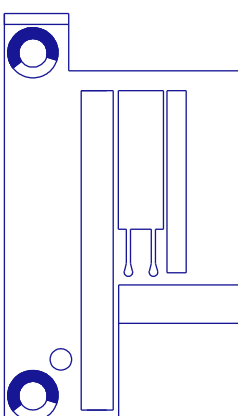

94282
PA22321

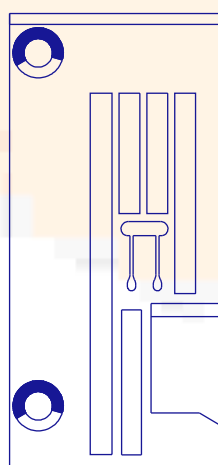

95260
PA22017

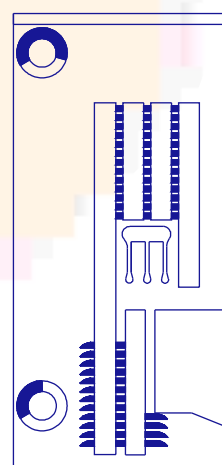

95278
PA22018

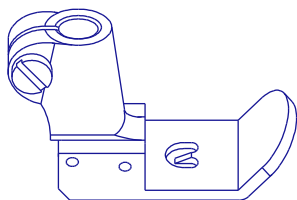

95581 3/16
PS22421

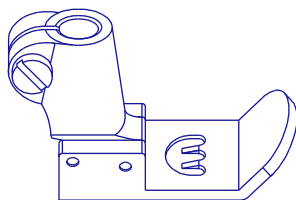

90731 1/4"
PS22432

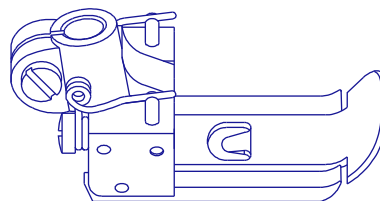

32345
PS22433

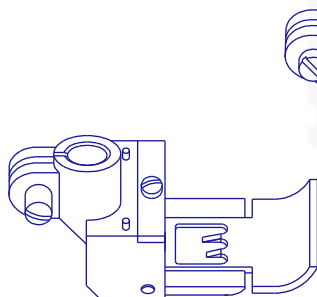

90722 7/32"
PS22431

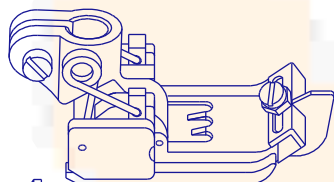

3507054G
PS22424

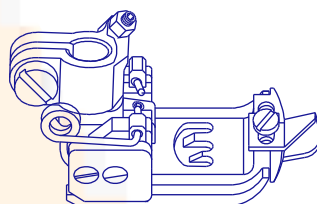

3507054
PS22425

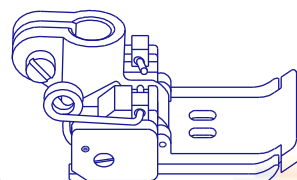

63671
PS22434

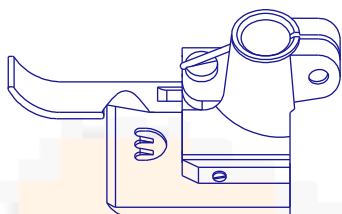

94909 1/4"
PS22331

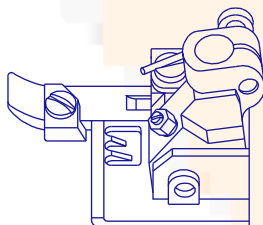

3207157
PS22423

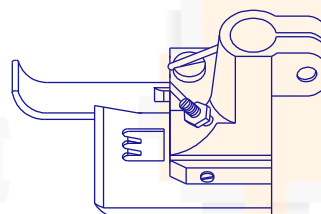

94908 7/32"
PS22332

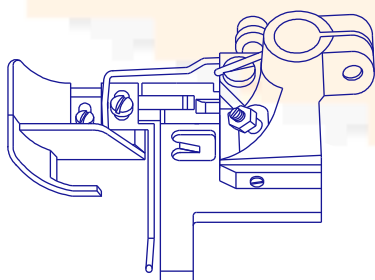

95313
PS22234

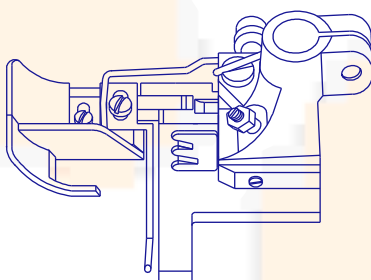

95316
PS22237

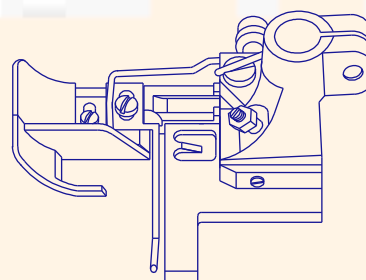

3207001
PS22236

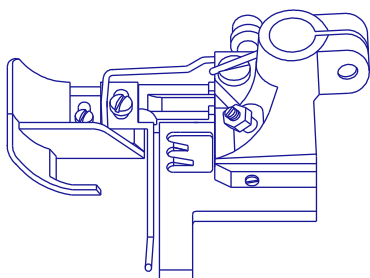

3207004
PS22235

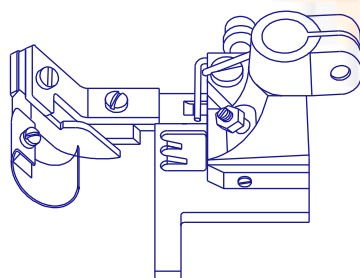

92158 7/32"
PS22231
92159 1/4"
PS22232

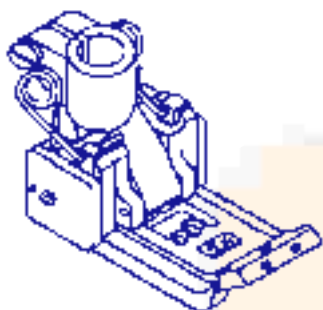

63319 - 4mm 2Ag.

PS22230

63320 - 4,8mm 2Ag.

PS22229

64041 - 5,6mm 3Ag.

PS22228

64042 - 6,4mm 3Ag.

PS22227

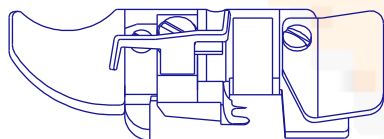

32343
PS22422

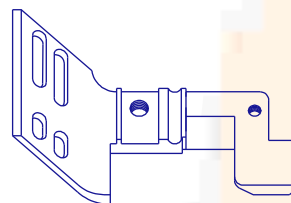

2117026
PS22233

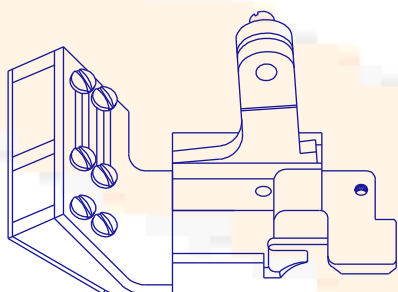

2117041
PS22436

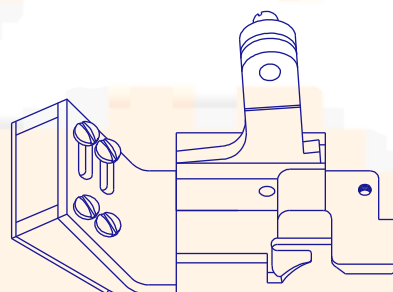

2117025
PS22435

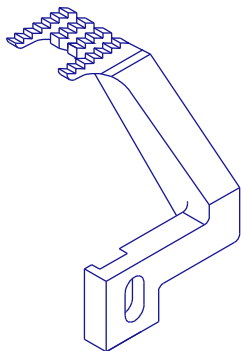

93394
DT22431

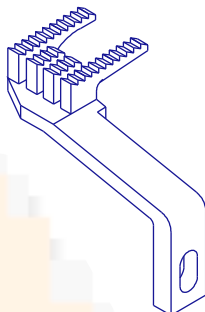

93395
DT22432

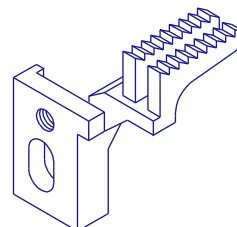

33814
DT22002

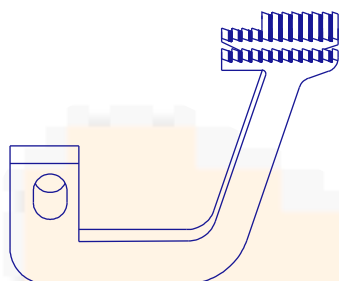

32881
DT22001

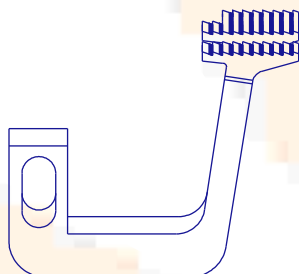

33813
DT22438

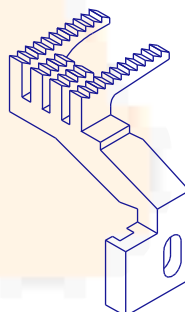

3109005
DT22433

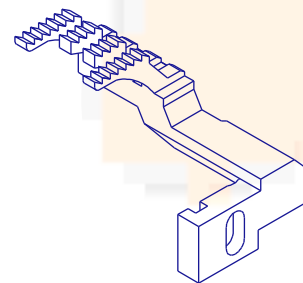

3109000
DT22434

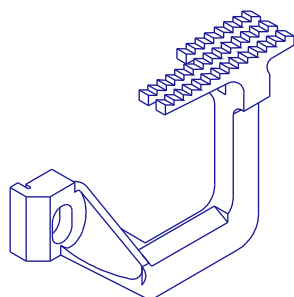

2119002
DT22435

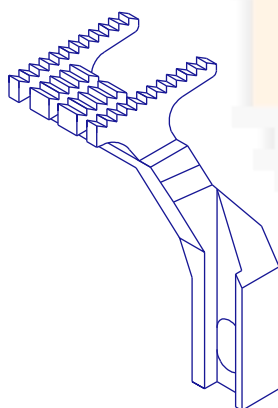

3209011
DT22003



2119003
DT22436

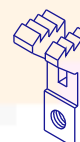

2119003/1
DT22437

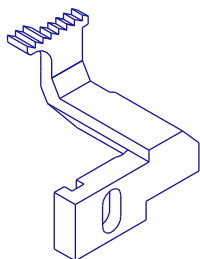

3509000
DT22009

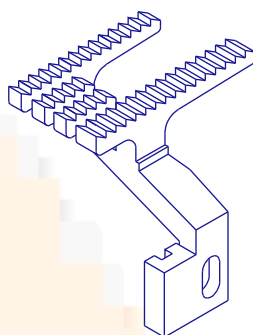

3509001
DT22010

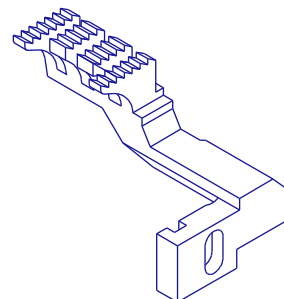

3509004
DT22007

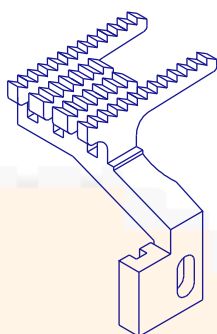

3509005
DT22008

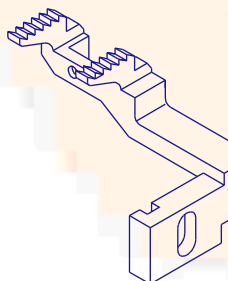

3509007
DT22005



3509012
DT22006

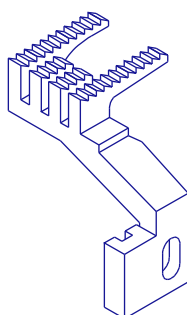

3509017
DT22004

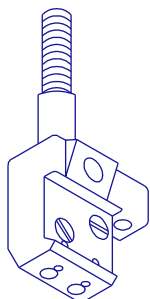

93353
SA22421

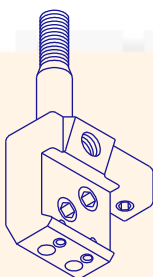

93352
SA22422

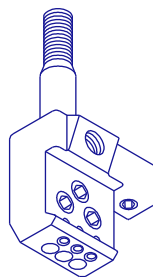

93357
SA22423

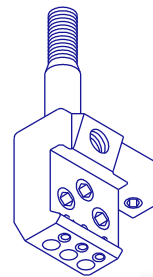

93358
SA22424

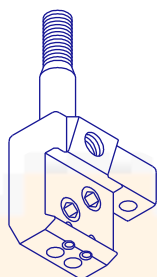

93351
SA22425

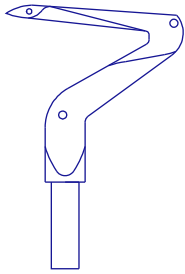

32790
AN22001

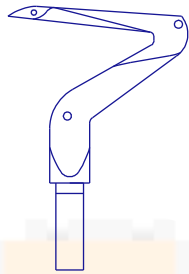

34392
AN22002

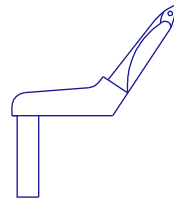

32807
AN22003

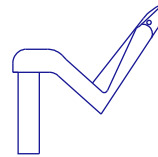

34730
AN22006

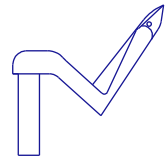

34519
AN22007

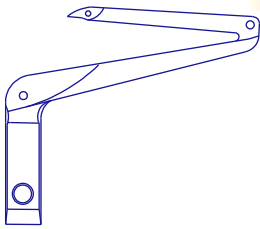

2119324
AN22011

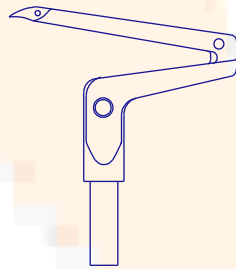

2109347
AN22015

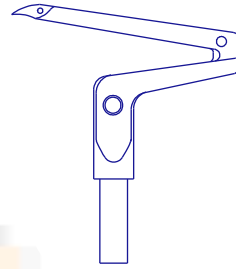

2109300
AN22012

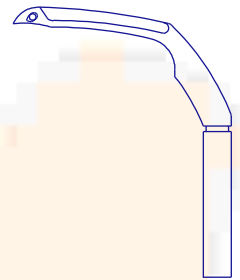

2109302
AN22013

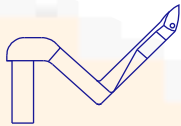

2119302
AN22017

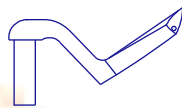

2109320
AN22014



3109300
AN22009

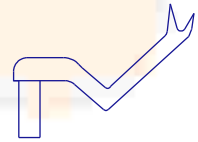

2119308
AN22010

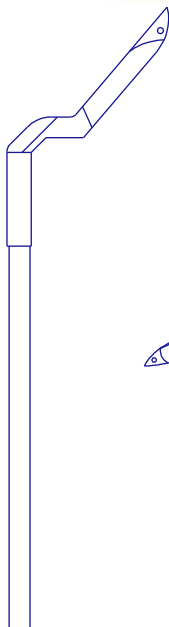

34348
AN22005

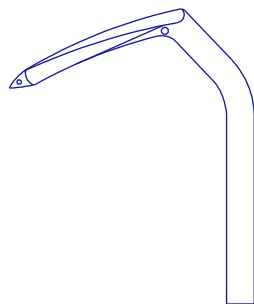

33059
AN22004

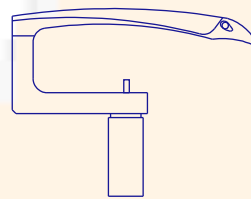

3209311
AN22016

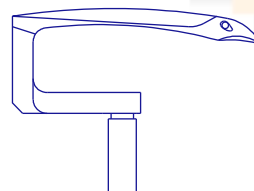

94480
AN22008

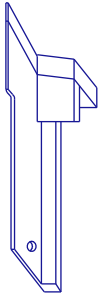

35286
CH22001

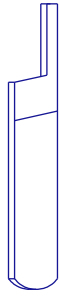

32914
CH22002



35285
CH22006



30421
CH22003



37514
CH22004



22195
CH22008



3110038
CH22014



38332
CH22005

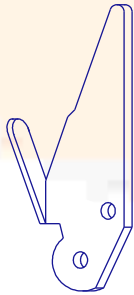

32706
CH22007



95277
CH22201



3201062
CH22203

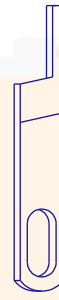

20496
CH22009

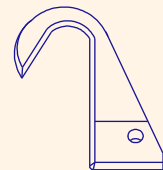

95276
CH22202



20271
CH22010



3100512
CH22204



2110305
CH22206



68121
CH22012



36250
CH22013



3100513
CH22205

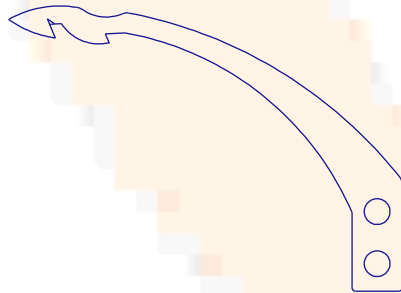

95399
CH22011

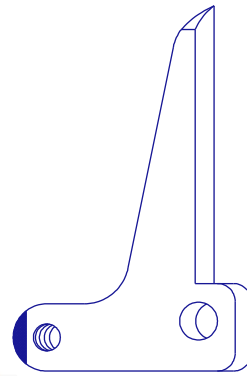

2114012
CH22207

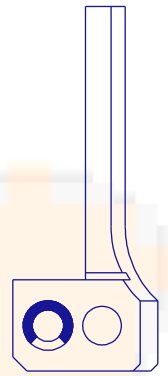

2114013
CH22208



63280
VA2212092



63280/1
VA2212093

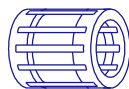

93212
VA2212094

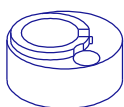

32822
VA229904



34147
VA229905

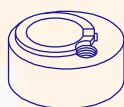

32823-8
VA229909



32825-10
VA229906

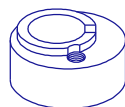

34150-10
VA229907

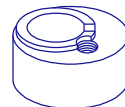

34146-6
VA229910

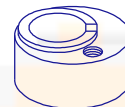

34148-8
VA229908

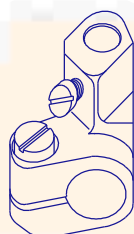

3100162
VA2299804



32899
VA2212096



Y33250
VA2200801



32655
VA2299801

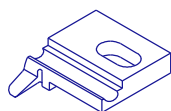

2107221
VA229911



93509
VA2212098

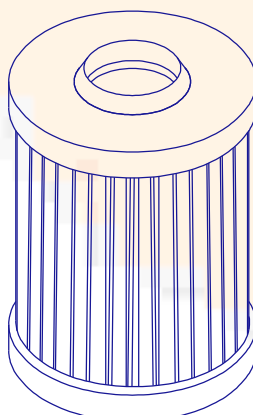

3100345
VA2200800



90344
VA2212091

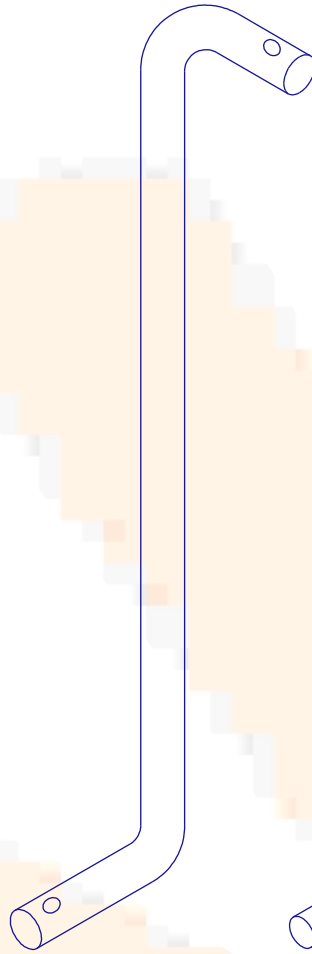

VA229902

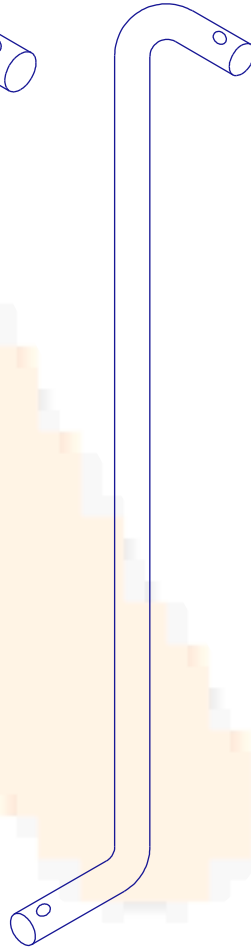

VA229901



190034
VA2212095



93507
VA2212097

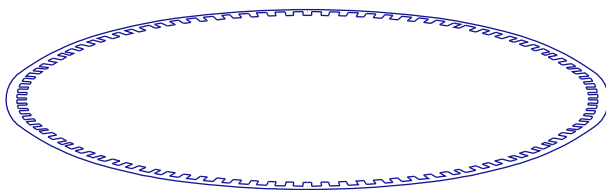

93088
VA229903



32974
VA2299802

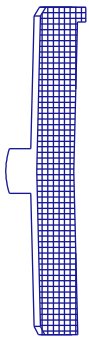

S2-196NLL
PS14923

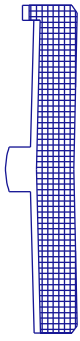

S2-196-NLR
PS14921

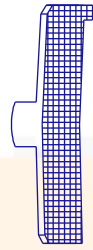

S2-196NSL
PS14924

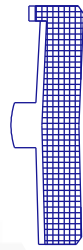

S2-196NSR
PS14922

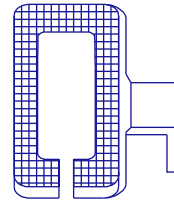

20-0650-0-501
PS14912

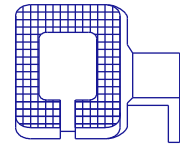

20-0650-0-401
PS14911

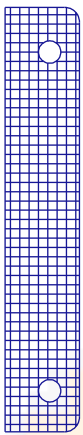

20-0208-0-071
VA1492803

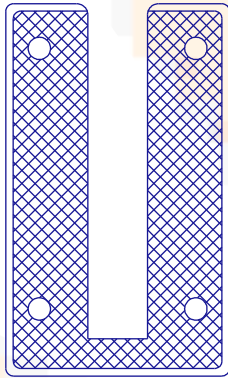

20-0208-1-224
VA1492804

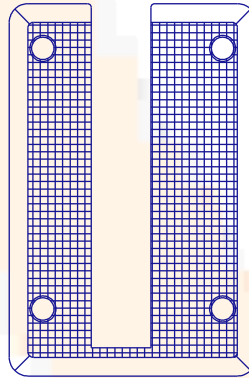

20-0208-1-315
PS14925

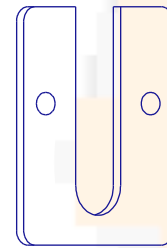

20-0655-0-39
VA1499806

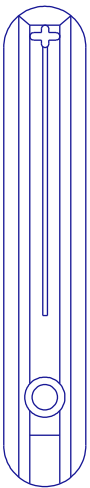

20-0051-1-024
PA14921
20-0051-1-024J
PA14922

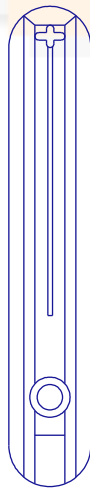

20-0051-1-002
PA14911
20-0051-1-002J
PA14912

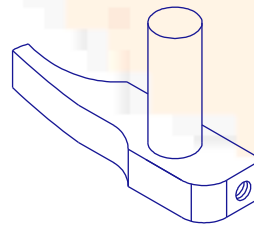

20-0641-2
VA1491801

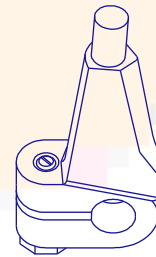

20-0092-0-004
VA1499809

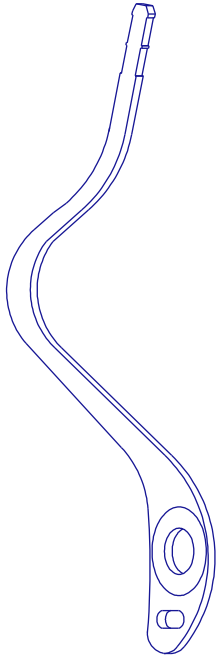

20-0194
VA1492801

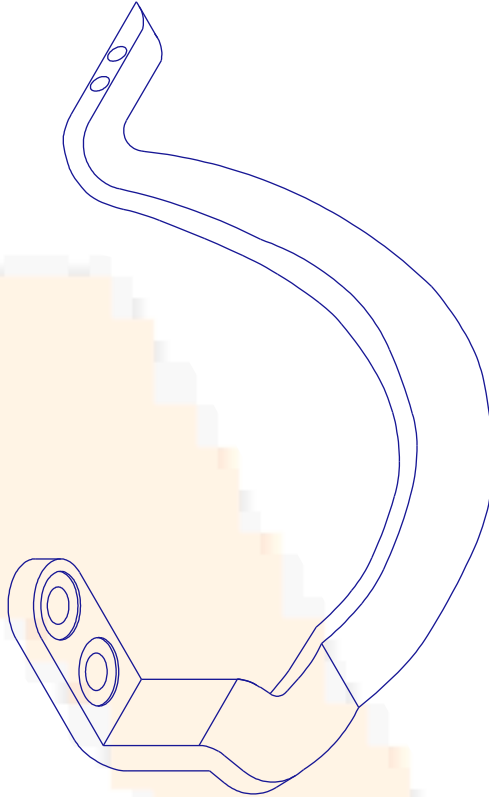

20-0649-0-041
VA1491120

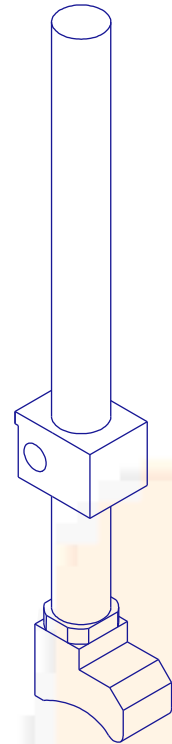

20-0309-0-100(S2-309)
VA1499803

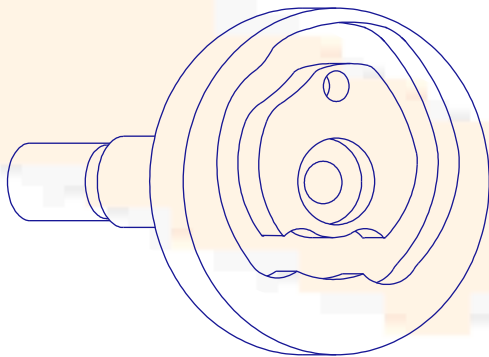

20-0276-2
VA1499818

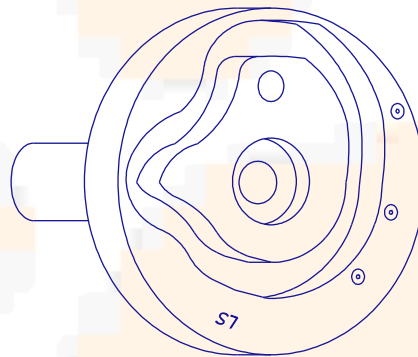

20-0276-1-004
VA1499835



D-4
AN14924



D-5
AN14923



S-116-N
AN14921
S-116-NJ
AN14911



S-119-N
AN14922
S-119-NJ
AN14912

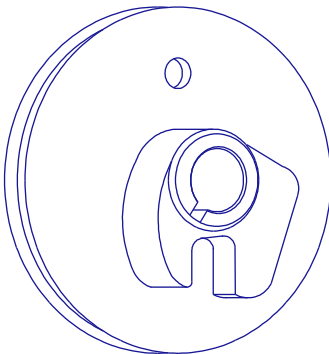

20-0074-2(S2-74--N)
VA1491803

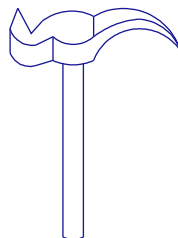

D-8
AN14925

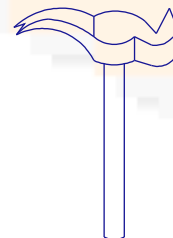

D-9
AN14926



S2-94
CH14911

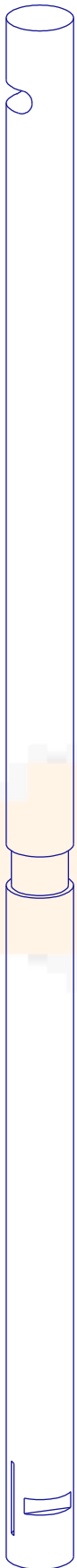

3/16	13/16
1/4	7/8
5/16	15/16
3/8	1
7/16	1 1/16
1/2	1 1/8
9/16	1 3/16
5/8	1 1/4
11/16	1 5/16
3/4	1 3/8
	1 1/2

S-356-N (Medida)

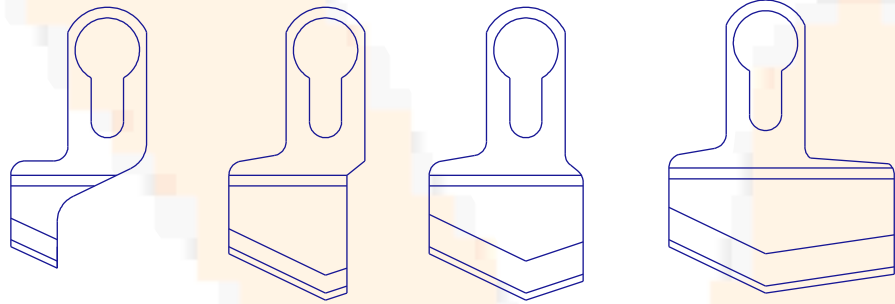

20-0356-1-050

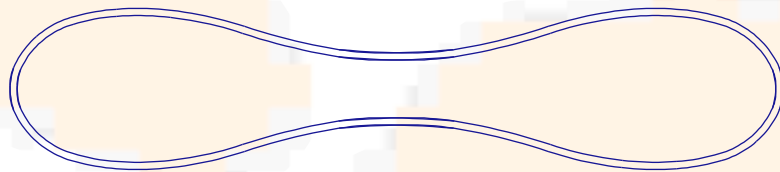

RG-102 (#05-0102-1-335)
VA1499807

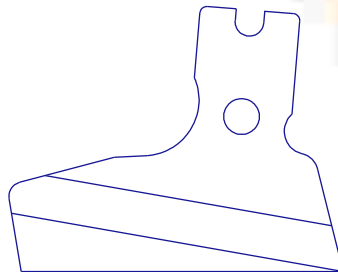

20-0356-0-003
CH14930



C72-11/4 RJ
CH14931

20-0070-3
VA1499801

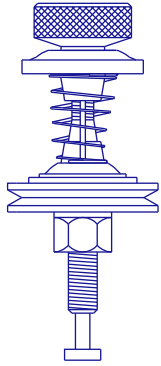

TR-2
VA14990830

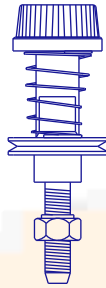

TR-3
VA14990831



TR-1
VA14990832

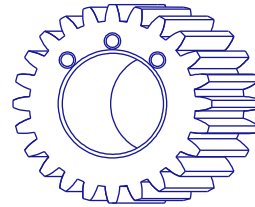

20-0019-0-100
VA1499830

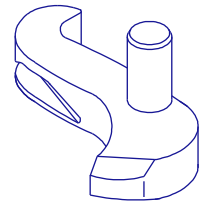

20-0271
VA14921803

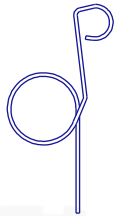

01-5148
VA1499828

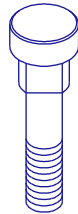

20-0041
VA1492805



01-6096
VA1499831



10-1116
VA1492807

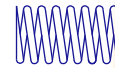

01-5022
VA1492806



01-4003
VA1199834



01-5020
VA1499829



01-5174
VA1492121



01-8002
VA1499170

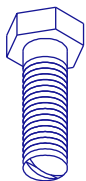

01-2386
TN1493122



01-2385(2385)
TN1493123



01-1125
TN1493121

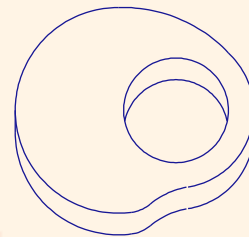

VA1499832

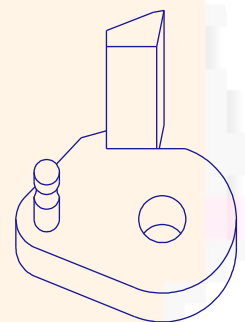

20-0308
VA1499836



20-0582
VA1199146

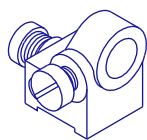

20-0115
VA1499821

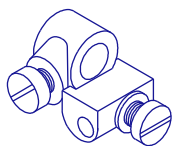

20-0118-1
VA1499822

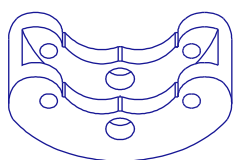

20-0110-1
VA1499813

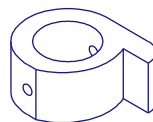

20-0086-1
VA1499804



01-5143
VA1499819

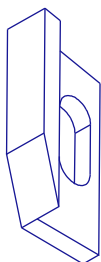

20-0583(S-583)
VA1499110



20-0360-1
VA1499111

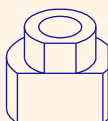

20-0613
VA1499817

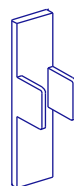

20-6064
VA1499816



20-0569
VA1499814



20-0001
VA1499815



20-0093-0-004
VA1499805



20-0093-0-000
VA1492802



20-0107-1
VA1499823

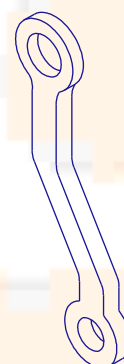

20-0608
VA1499825

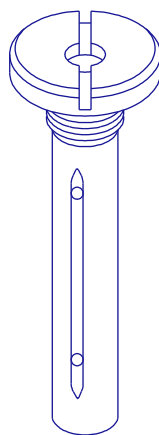

20-0281
VA14921804

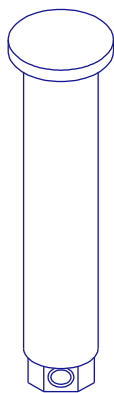

20-0345
VA14921801

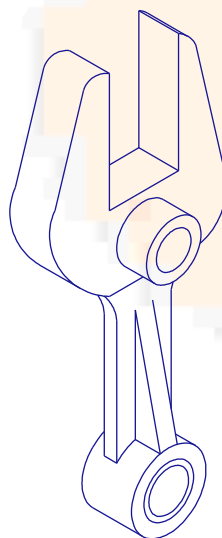

20-0122-0-100
VA1499824

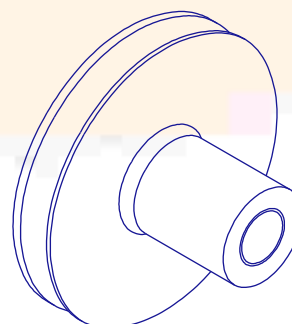

20-0346-2
VA14921802



JUEGO BORAS 3 AGUJAS

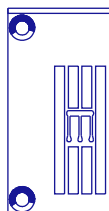

52824X-16 1/4"
PA21431

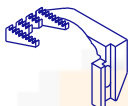

3026A
DT21432

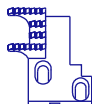

52805X-16
DT21431

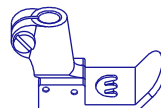

52820X-16
PS21201

JUEGO TIRA 3 AGUJAS

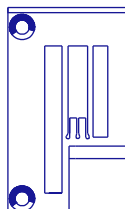

52824K16
PA21331

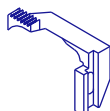

52826-K
DT21331

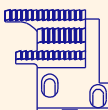

52805K
DT21332

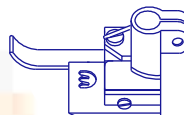

52820K16
PS21331

JUEGO DIENTE DE RATA

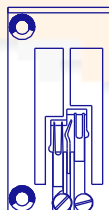

79228A
PA21121

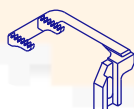

53426A
DT21421

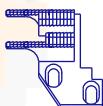

53405A
DT21422

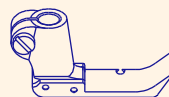

79220BB
PS21123

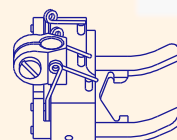

79220A
PS21122

JUEGO CADENETA SACOS

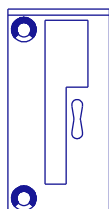

51124-D
PA21151

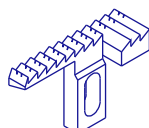

51105-G
DT21151

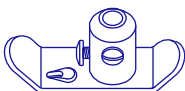

51120H
PS21111

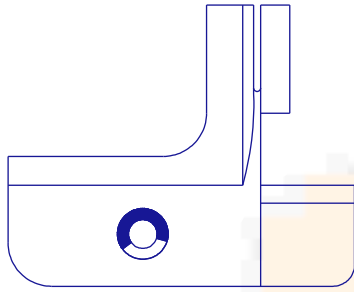

A-10230HB
PA21011

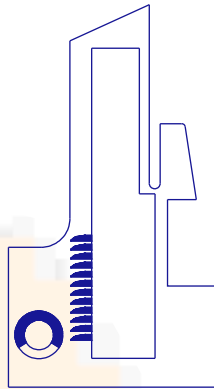

39524J 3/16
PA21012

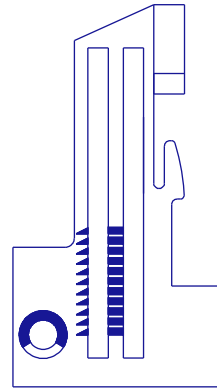

70-002
PA21432

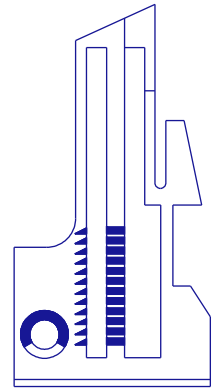

39524B-1/8
PA21433

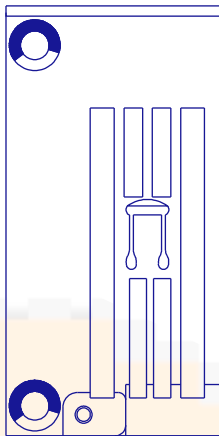

34724H-12
PA21013

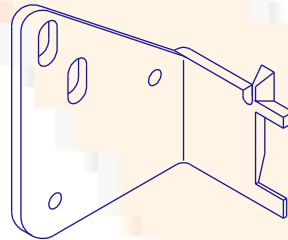

A-10021HB
PS21011

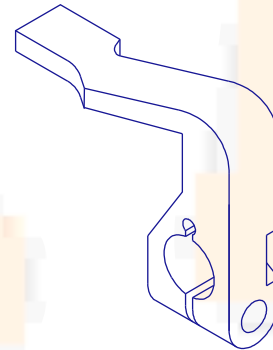

51125-E
VA2110803



56358
VA2111801



L-79230H
VA2112013



79230D
VA2112011



L-79230G
VA2112012



51110-D
VA2111802

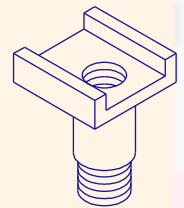

56334-L
VA2110801



53325
VA2111803

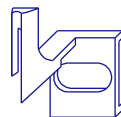

53425
VA2112801

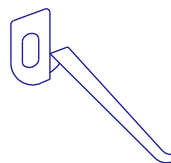

S-53411C
VA21990801

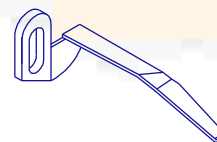

53411-B
VA2112802



36240
VA2110802

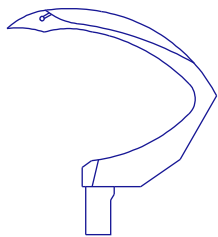

35809-AY
AN21101

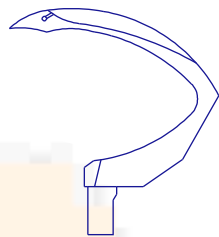

35808-AY
AN21102

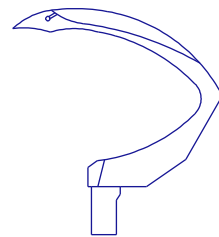

35809-BY
AN21103

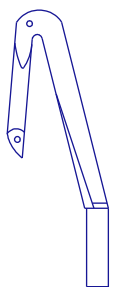

39508-B
AN21104

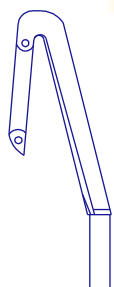

39508-B"J"
AN21906

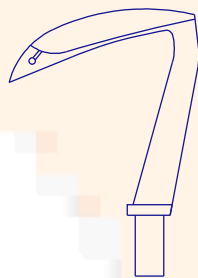

31108
AN21001

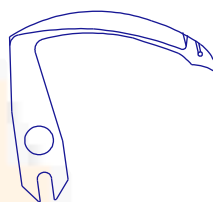

32822
AN21404

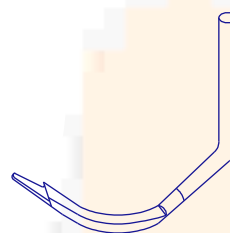

52845A
AN21105

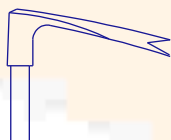

39560-A
AN21901

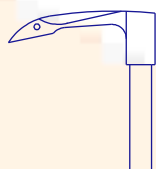

54208-A
AN21903

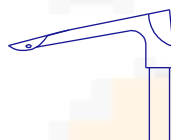

39508-A
AN21902

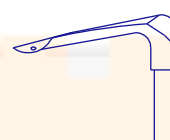

39508-A"J"
AN21907

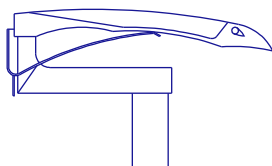

53407
AN21905

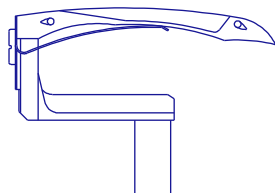

53409
AN21904

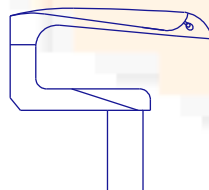

G51409C
AN21401



2200
AN210101

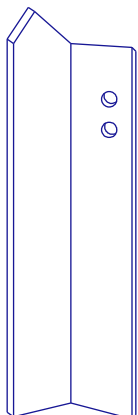

51470
CH21001

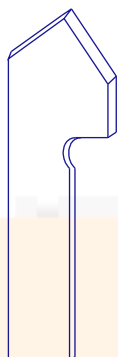

51449
CH21002



G39570
CH21008



39570
CH21004

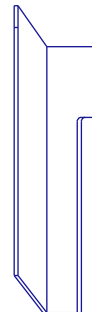

39570J
CH21005

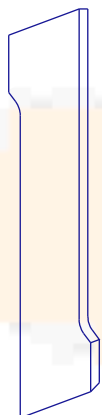

39549J
CH21006

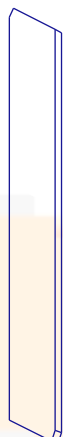

39549
CH21007



34770K
CH21010

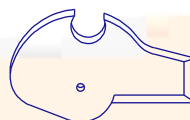

99670RH
CH21003

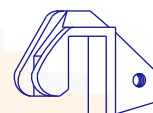

C01037A-5
CH21009



G3025
VA2112803

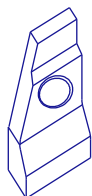

39550AD
VA2112804



79020A6
VA2112016

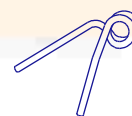

79020A8
VA2112014

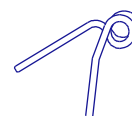

79020A7
VA2112015

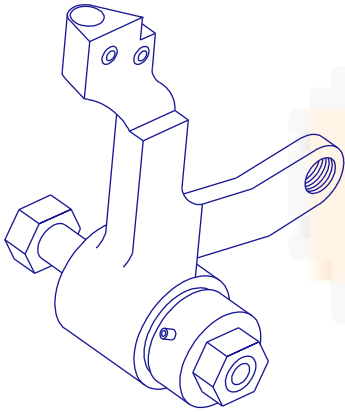

53413
SA21021

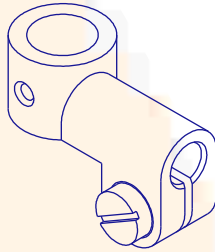

53374
VA2110804

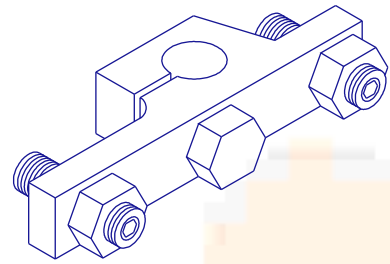

39555-C
VA2112806

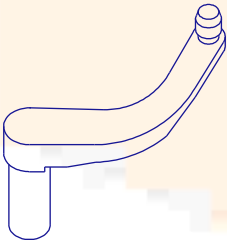

VA2112805

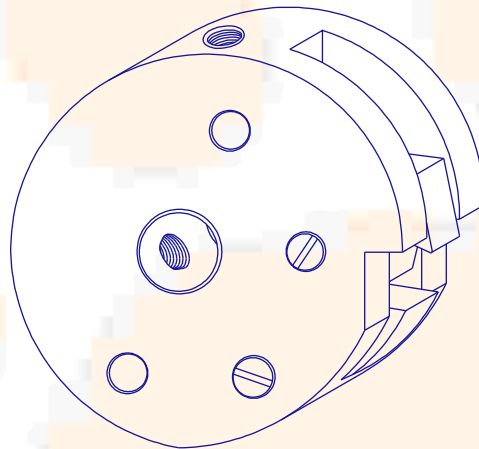

44-554
VA2111804

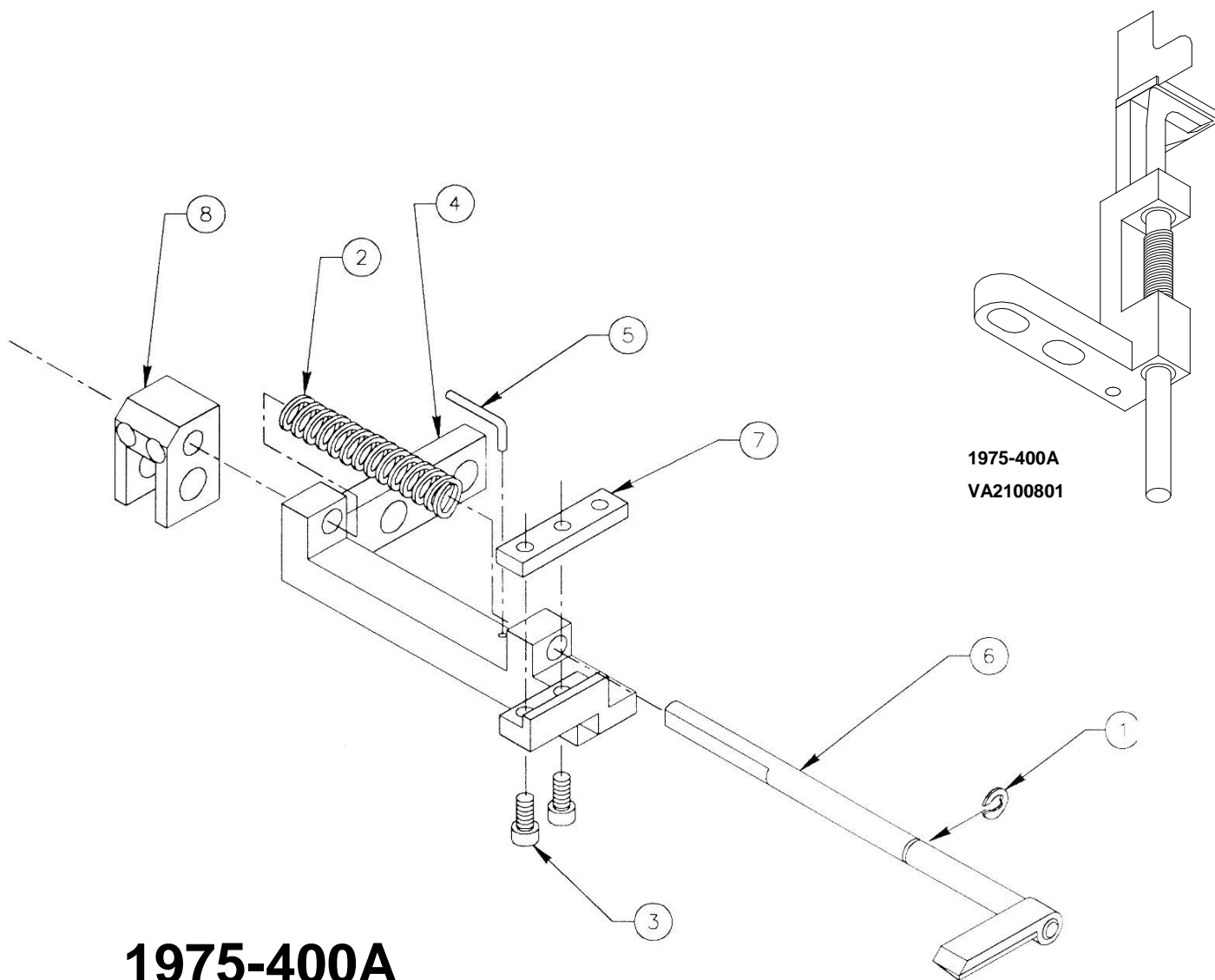

1975-400A

ITEM	Referencia	Descripción	Cantidad
1	M8407A118	3/16 Clip ext.	1
2	RLC024C14	Muelle	1
3	SSC70016	Tornillo	2
4	1975-401A	Cuerpo cuchilla	1
5	1975-402	Guía de rosca	1
6	1975-405A	Eje cuchilla regulable	1
7	1975-406A	Fijación cuchilla	1
8	1975-407	Horquilla	1

NOTA: 1975-406A Posicionador de cuchilla tiene 4 lados afilados, tiene que girarse 3 veces.



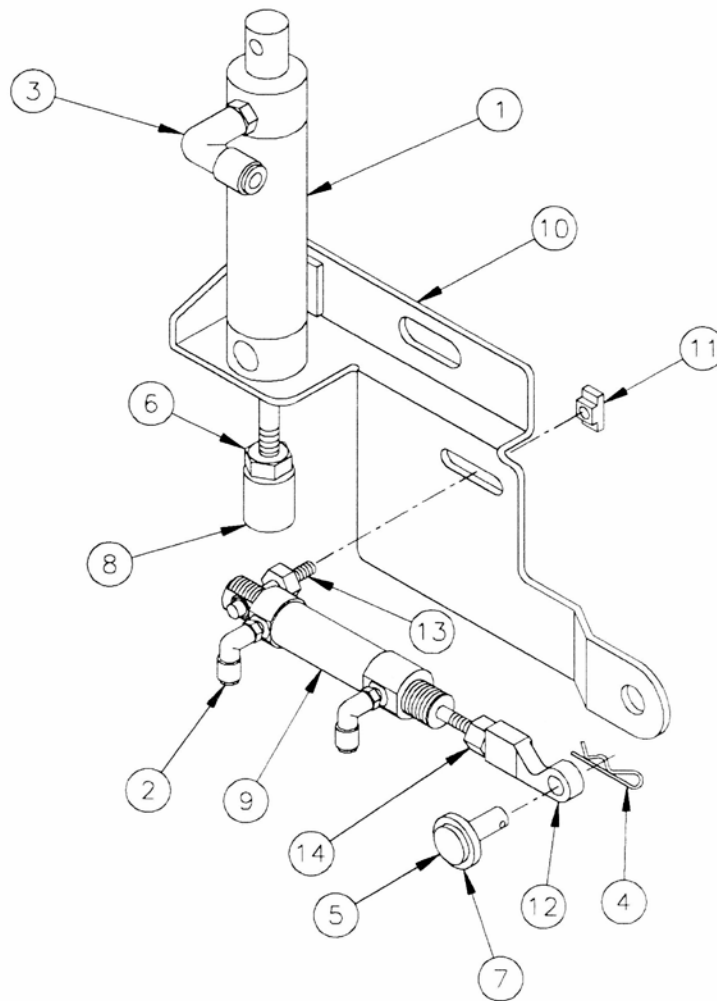

1975-400P1

ITEM	Referencia	Descripción	Cantidad
1	AC7 DP-1	Cilindro neumático	1
2	AQME-5-10	Rácord rápido acodado	2
3	AQME-5-8	Rácord rápido acodado	1
4	M92390aA15 1/4x3/4	Clavilla elástica	1
5	M98335A04	Pasador clavilla	1
6	NJ1/4-28	Tuerca 1/4 28	1
7	WFF1/4A	Filtro lavado	1
8	*1200	Tope goma	1
9	1975-213	Cilindro neumático modificado	1
10	1975-237	Soporte cilindro	1
11	1975-238	Tuerca en T	1
12	1975-408	Guía unión	1
13	1976-048	Pivote soporte	1
14	1975-049	Contratuerca	1



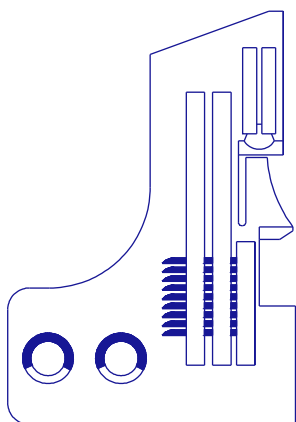

205236
PA19011

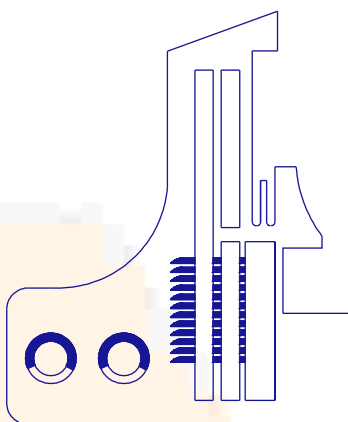

PA19021

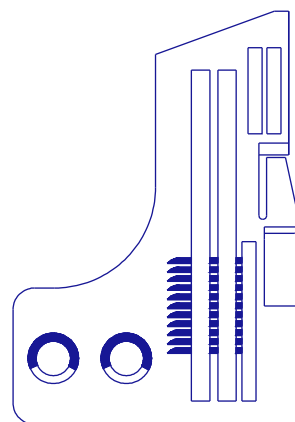

PA19012

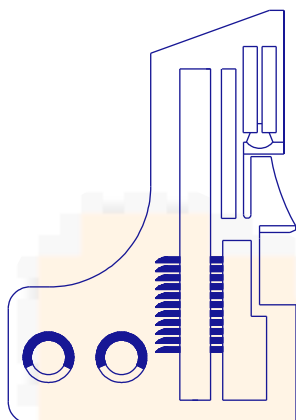

205321
09-009611-37
PA19013

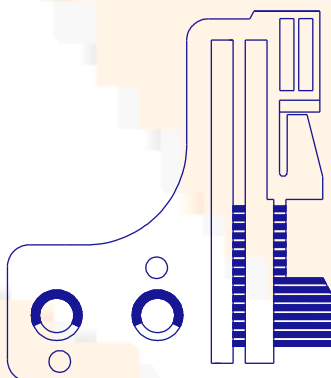

PA19014

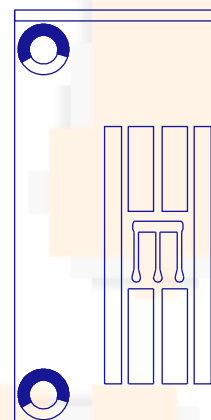

257018B56
PA19431

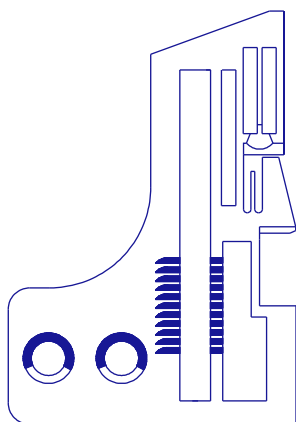

9071-07
PA19022

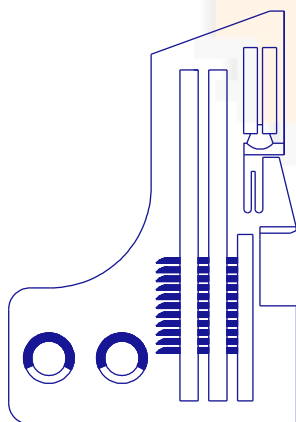

9611/32
PA19023

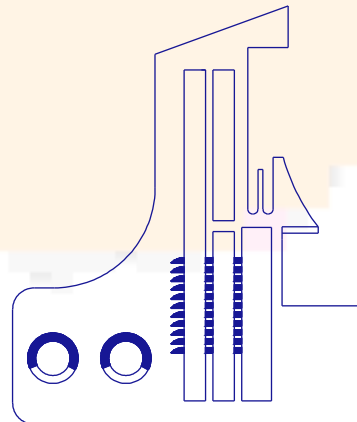

9611-43
PA19024

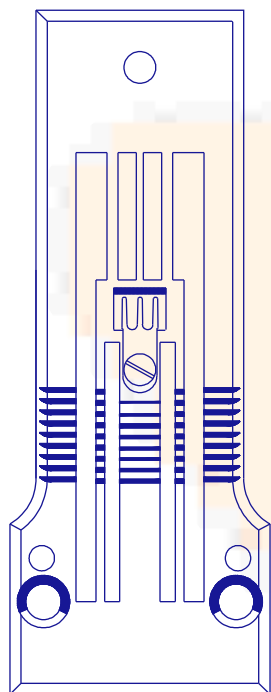

08-701083
PA19025



08-701080
VA1910032

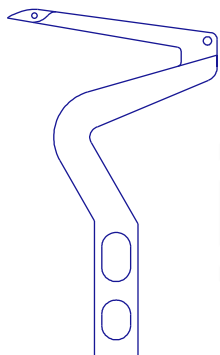

210356
AN19001

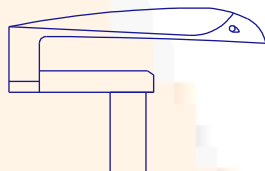

712082
AN19101

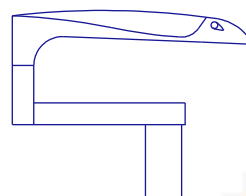

F-23100-37A
AN19401

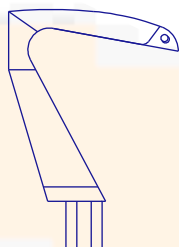

700565J
AN19901
700565
AN19903



210365
AN19002

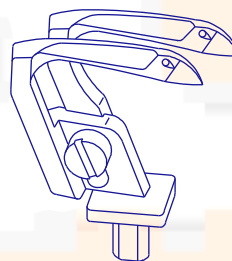

96-700713-91
AN19902

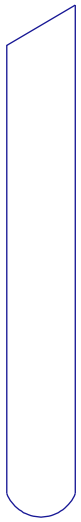

323-870-210
CH19001



700-591
CH19901



21-815
700535
CH19902

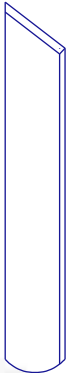

720745
CH19903

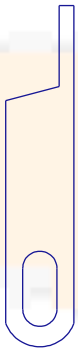

323-870-200
CH19005



323-870-214CT
CH19002



720736
CH19904

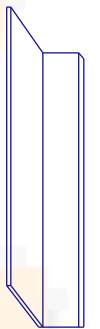

720735
CH19905

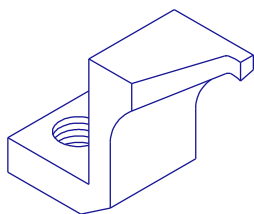

001
CH19906

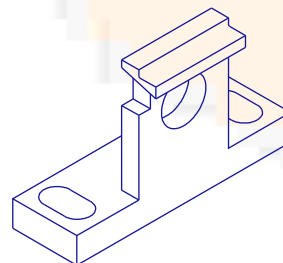

002
CH19907

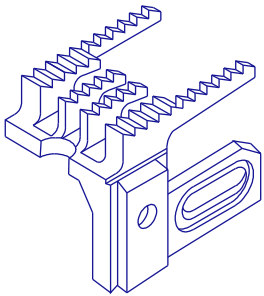

95-702925
DT19101

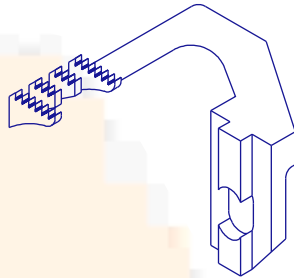

96-711174-05
DT19435

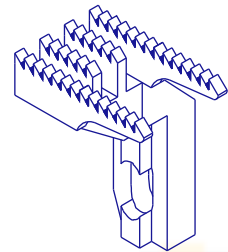

705586
DT19436

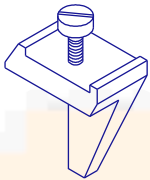

C46211-40
VA1910031

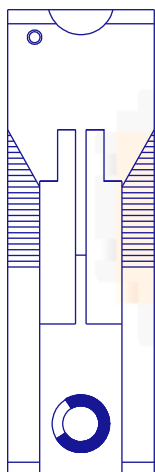

212UCA-1/4
PA18714

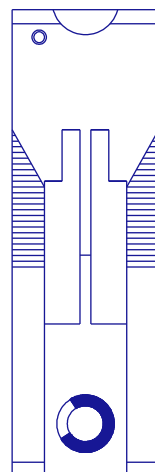

212UCA-3/16
PA18713

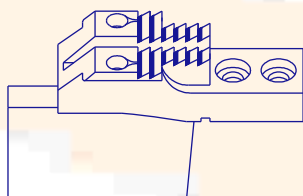

212AFD-1/4
DT18002

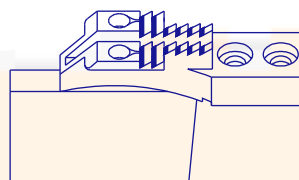

212AFD-3/16
DT18001

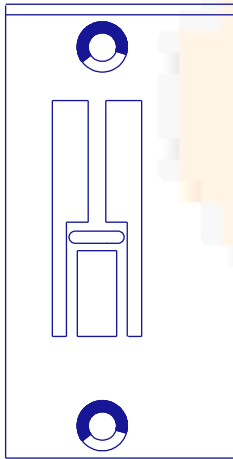

210601
PA18711

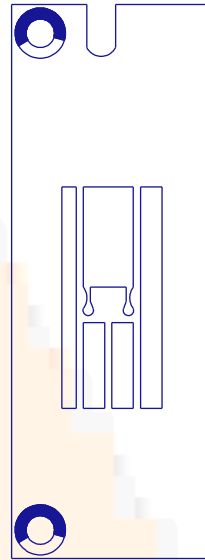

156092
PA18121

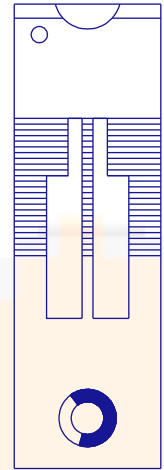

223884-1/4
PA18715

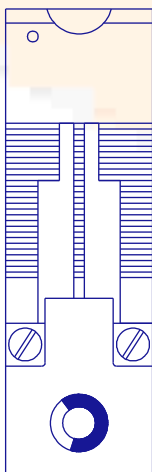

PA40401

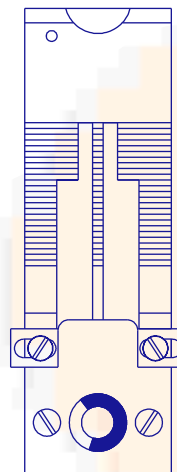

PA40402/1-3/16
PA40403/1-1/4

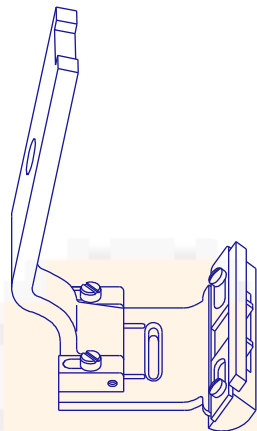

PR-503896

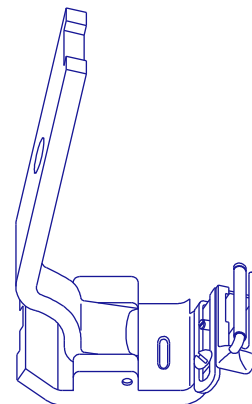

PR-107E

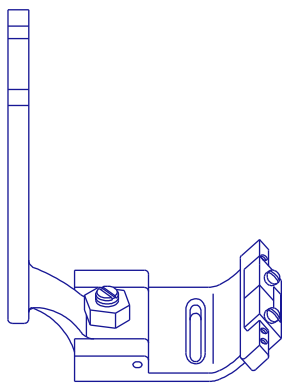

PR-457GB

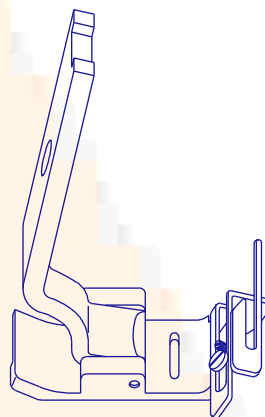

PR-107C

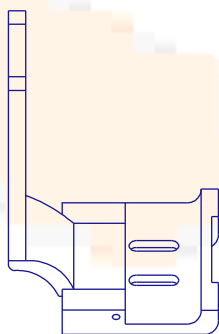

PS18723
ESPECIAL AROS SUJETADOR

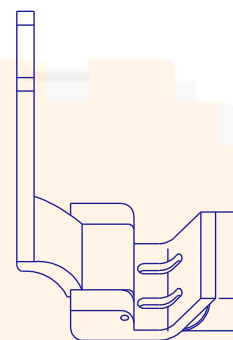

PS18724
PRENSATELAS PARA
ABRIR COSTURAS

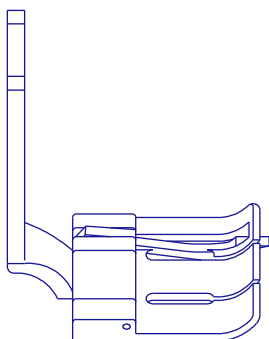

PR-S570 1/4

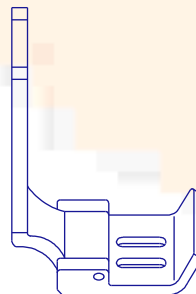

224158-3/16
PS18722

223759-1/4
PS18725

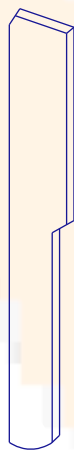

146728
CH18001



164550
CH18002



502668
VA40998143



237174(72w)
VA40998144



PLACA AGUJAS

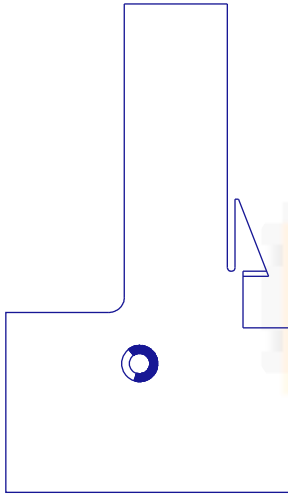

PUNTERAS
PA40402

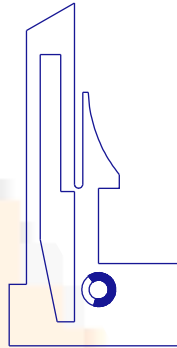

TAKATORI
PA40404

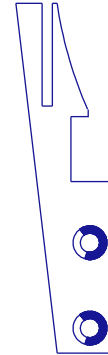

AUTOGASET
PA40405

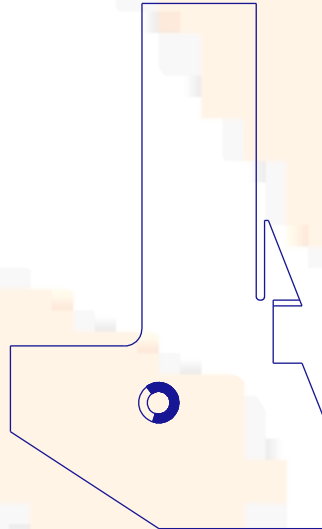

HSH
PA40403

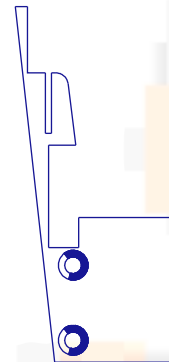

AUTOLINK
PA40406

ANCORAS

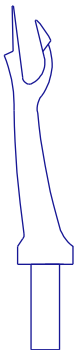

36-16
AN40991
LEWIS

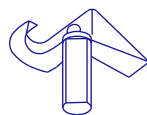

36-19
AN40992
LEWIS

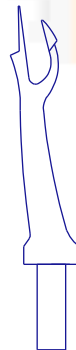

11837
AN43931
TRAESURE



323-810-218
AN44001
WILLCOX & VIBBS

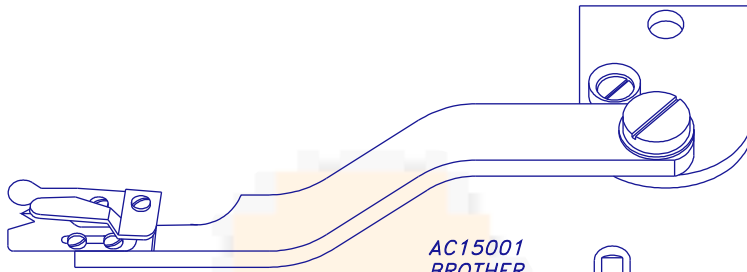

AC15001
BROTHER

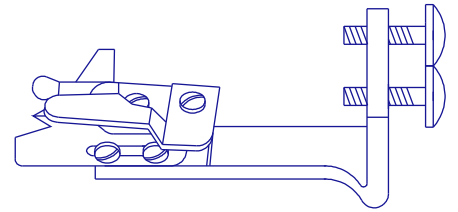

AC12001
SIRUBA

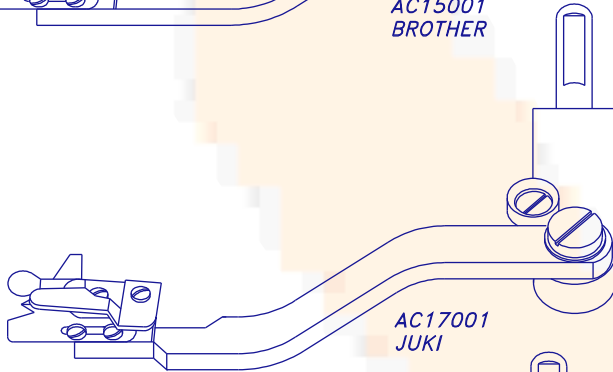

AC17001
JUKI

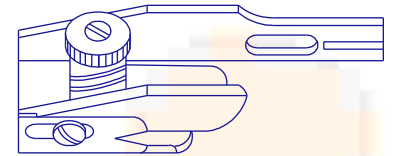

920632
AC11001
RIMOLDI

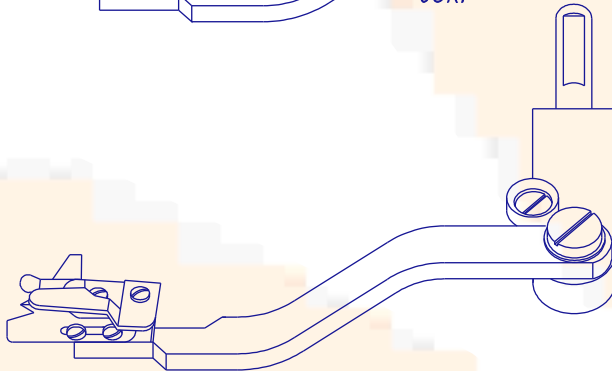

920776-4-10
AC11002

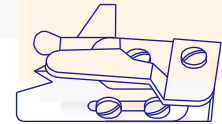

920775-4-10
AC11003

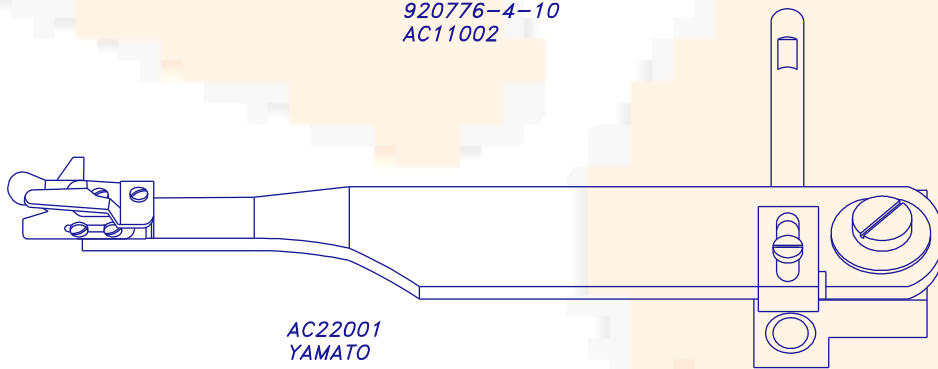

AC22001
YAMATO



920757-2-10
AC11004

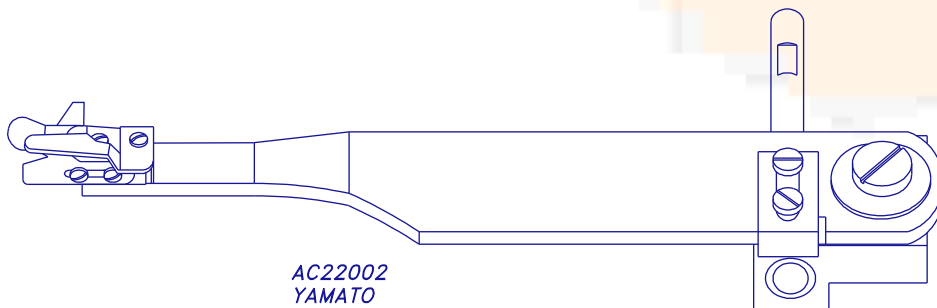

AC22002
YAMATO



ASPIRADORES DE CADENETA



ITEM	Clase máquina aplicable/ Modelo
T041	Aspirador plano completo Juki MO-3600, 3700, 3900 con 5 hilos máquina de tira
T041-A	Aspirador plano completo Juki MO-3600E, 3700E, 3900E
T041-AB	Aspirador plano completo Juki MOR-3900
T042	Aspirador vertical completo Juki MO-3600, 3700, 3900 con 3 ó 4 hilos máquina de tira ow.
T035	Aspirador plano completo Juki MO-2300, 2400, 2500 con 5 hilos máquina de tira
T022	Aspirador plano completo Juki MO-2300



ASPIRADORES DE CADENETA



ITEM	Clase máquina aplicable/ Modelo
301148 (KS301148)(KS002)	Aspirador vertical completo Pegasus (W&G) E52, L52, etc.
301030(KH301030)(KH001)	Aspirador plano completo Pegasus (W&G) E32 (material medio o fino)
301235(KH301235)(KH003)	Aspirador plano completo Pegasus (W&G) E32 (material extraduro o medio)
303753(KH303753)(KH010)	Aspirador plano completo Pegasus (W&G) L132 (material medio o fino)
303754(KH303754)(KH012)	Aspirador plano completo Pegasus (W&G) L132 (material extraduro o medio)
308046- 91 (KS308046- 91)(KS372)	Aspirador vertical completo Pegasus (W&G) EX5200, LX5200, EX5400
308020A91(KH308020A91Y)(KH020A)	Aspirador plano completo Pegasus (W&G) EX3200, LX3200 standard



ASPIRADORES DE CADENETA



ITEM	Clase máquina aplicable/ Modelo
T043	Aspirador vertical Juki
T036	Aspirador vertical completo Juki MO- 2300, 2400, 2500 de 3 ó 4 agujas overlock
308045- 91(KS308045- 91)(KS371)	Aspirador vertical completo Pegasus (W&G) EX5200, LX5200, EX5400
308047- 91(KS308047- 91)(KS373)	Aspirador vertical completo Pegasus (W&G) EX5200, LX5200, EX5400
308020B91Y(KH308020B91Y)((KH020B)	Aspirador plano completo Pegasus (W&G) EX3200, LX3200 metal duro
2109906 (K1)	Aspirador plano completo Yamato AZ8500, AZ8600, etc
2109917 (K2)	Aspirador vertical completo Yamato AZ8003, AZ8000, 6000, 6003, etc
S24274- 0- 01	Aspirador plano Brother EF- 4V, B661
S24273- 0- 01	Aspirador vertical Brother B661, (CV1)
CT	Aspirador plano Siruba mod. 757
VT	Aspirador vertical Siruba mod. 737, 747
DT	Aspirador plano
SS	Aspirador vertical Kingtex SH- 6000
US	Aspirador plano Kingtex SH- 6000

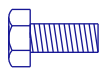

202488-0-10
TN1100030



202489-0-10
TN1100020



744742-0-00
TN1100010



741546-2-00
TN1100803



744730
TN1110010



742222-2-00
TN1100051



745810-2-00
TN1140211

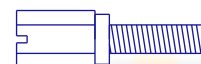

302152-0-10
TN1140212



SK-260
TN1200011

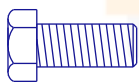

SK-298
TN1200231



SK-230
TN120012



84-464
TN2040011



84-314
TN2040211



01-1125
TN1493121



SS-2110710-TP
TN1700011



TN1800011



TN2600011

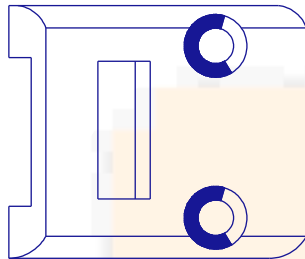

069-00-133
PA31111

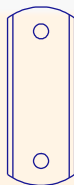

167462
CH31991

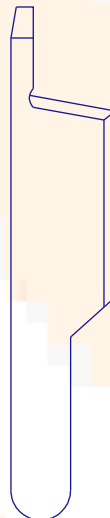

167461
CH31992



367330780
CH31993

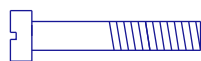

301603-0-10
TN1110141



202496-0-10
TN1100802



203187-0-10
TN1140031



SK-216
TN1200211



721525-0-00
TN1100801



300120-0-10
TN1120121

RIMOLDI	
REFERENCIA	CODIGO
203658-0-10	TN1120122
204947-0-10	TN1100121
301546-0-10	TN1120805
301604-0-10	TN1120801
301795-0-10	TN1140229
302152-0-10	TN1140212
302338-0-10	TN1140214
302341-0-10	TN1140801
302351-0-10	TN1140215
302352-0-10	TN1140226
302355-0-10	TN1140233
302708-0-01	TN1120806
303503-0-10	TN1150004
304412-0-10	TN1120804
308039-0-01	TN1150002
308281-0-00	TN1140227
308855-0-00	TN1140213
703005-0-00	TN1150008
704210-4-00	TN1150001
705013-0-00	TN11990801
721410-0-00	TN11008015
721494-2-00	TN11008020
722410-2-00	TN1140223
727056-0-00	TN1150009
729051-2-00	TN11990802
734464-2-00	TN1100011
741433-0-00	TN1140224
741642-2-00	TN1120803
741658-2-00	TN1140219
741665-0-00	TN1140232
741721-2-00	TN1140121
741724-2-00	TN1150011
742282-2-00	TN1140216
744530-0-00	TN1140221
744631-2-00	TN1150010
744636-2-00	TN1120221
744656-2-00	TN1140217
744676-2-00	TN1140230
745800-2-00	TN1100211
745812-2-00	TN1110101
746408-2-00	TN1150005
923753-0-00	TN11008013
923758-0-00	TN1140222
923919-0-01	TN11008014
	TN11008016
308161-0-00	TN1100012
745001-0-00	TN1100013
746612-2-00	TN1100014
729013-2-00	TN1100015
745114-0-00	TN1100016
924673-0-10	TN1100017
203231-0-10	TN1100151
721424-0-00	TN1100154
704218-2-00	TN1100155
302204-0-10	TN1100156
741415-0-10	TN1100157
303728-2-00	TN1100158
721412-2-00	TN11008018
300483-0-10	TN11008019
744573-0-00	TN11008021

RIMOLDI	
304684-0-10	TN11008023
721471-2-00	TN11008024
204799-0-10	TN11008025
303023-0-10	TN11008027
722441-2-00	TN11008028
932308-0-00	TN11008029
722070-2-00	TN1100810
729434-0-00	TN1100811
730011-2-00	TN1100812
741611-2-00	TN1110091
741431-0-00	TN1120123
724441-0-00	TN1140122
740444-2-00	TN1150012
741403-0-00	TN1150013
721883-0-00	TN11990803
737030-2-00	TN11990804
740632-2-00	TN11990805
741634-2-00	TN11990806
722030-2-00	TN11990807
724442-2-00	TN11990808
308235-0-00	TN11990809
741414	TN11990810
	TN11990811
744742-0-00	TN1100010
727030-2-00	TN1100018
727834-2-00	TN1100019
202489-0-10	TN1100020
730033-2-00	TN1100021
746007-2-00	TN1100022
303505-0-10	TN1100023
207421-0-01	TN1100024
722123-2-00	TN1100025
724411-0-00	TN1100026
304086-0-10	TN1100027
302353-0-10	TN1100028
202488-0-10	TN1100030
722401-2-00	TN1100031
722411-2-00	TN1100032
741461-2-00	TN1100034
741538-2-00	TN1100035
741654-2-00	TN1100036
742811-0-00	TN1100037
745827-2-00	TN1100038
741936-2-00	TN1100039
743243-2-00	TN1100040
721444-2-00	TN1100041
741413-2-00	TN1100042
745815-2-00	TN1100043
742222-2-00	TN1100051
721421-0-00	TN1100152
100458-0-10	TN1100153
721525-0-00	TN1100801
704216-2-00	TN11008010
741675-2-00	TN11008011
721434-2-00	TN11008012
721443-2-00	TN11008017
202496-0-10	TN1100802
741546-2-00	TN1100803
204934-0-10	TN1100804
704424-2-00	TN1100805
700205-0-00	TN1100806

RIMOLDI	
200699-0-10	TN1100807
744533-0-00	TN1100808
746021-2-00	TN1100809
744730	TN1110010
301603-0-10	TN1110141
300120-0-10	TN1120121
724471-0-00	TN1120801
729043-2-00	TN1120802
203187-0-10	TN1140031
745810-2-00	TN1140211
302354-0-10	TN1140225
304436-0-10	TN1140228

PEGASUS	
REFERENCIA	CODIGO
5373-HC	TN2910011
5590	TN2999801
4554	TN2910091
7019	TN29001
256041	TN29281
7098	TN29282
5511-HC	TN29280
7007	TN29283
7027	TN29284
4539	TN29285
7062	TN29286
7134	TN29287
7040	TN29288
7008	TN29289
7020	TN29290
7036	TN29291
7129	TN29292

KANSAI	
REFERENCIA	CODIGO
84-367	TN2010803
84-383	TN2040801
84-511	TN2018804
84-568	TN2040213
84-572	TN2010808
84-574	TN2040212
84-614	TN2010807
84-862	TN2010806
84-3630-0	TN2010802
84-3830-0	TN2010805
84-6150-0	TN2010801
85-210	TN209801
84-617	TN20108010
84-566	TN20108011
84-171	TN20108012
84-512	TN20108013
84-861	TN20108014
84-361	TN2010809
84-621	TN2010810
84-379	TN2010811
86-411	TN2010814
84-864	TN2040802
87-104	TN2010812
85-624	TN2010813
84-464	TN2040011
84-314	TN2040211

SIRUBA	
REFERENCIA	CODIGO
SK-207	TN1200801
SK-208	TN120014
SK-219	TN120016
SK-221	TN120013
SK-222	TN1200803
SK-230	TN120012
SK-241	TN120020
SK-242	TN120015
SK-245	TN120019
SK-262	TN1200802
SK-277	TN120018
SK-301	TN120017
SK-255	TN120010
SK-201	TN120011
SK-218	TN120021
SK-216	TN1200211
SK-250	TN120022
SK-295	TN120023
SK-209	TN120025
SK-19	TN120026
SK-261	TN1200804
SK-260	TN1200011
SK-271	TN120008
SK-243	TN120009
SK-298	TN1200231
SM031	TN120027



JUKI	
REFERENCIA	CODIGO
B-2523-372-000	TN179311
B-2543-372-L00	TN179383
B-2553-372-000	TN179384
NS-6680410-SP	TN1700807
SD-0640391-TP	TN179382
SS-4120615-SP	TN1700804
SS-6111610-SP	TN1700806
SS-8080310-TP	TN1700012
SS-9090813-TP	TN1700805
SS-9120643-TP	TN179380
SS-9151210-TP	TN1700801
SS-9621413-TP	TN179381
SD-0550301-TP	TN170013
SS-9111050-SP	TN170014
SS-4080610-SP	TN170015
SS-4121015-SP	TN170016
SS-6080410-SP	TN17001
SS-9090610-TP	TN17002
SS-7090910-TP	TN1700808
SS-9112310-SP	TN179312
SS-9111010-SP	TN179313
SP-0680271-SP	TN179314
SS-5060410-SP	TN179315
SS-9110430-TP	TN179385
SS-8110422-TP	TN179386
SS-6090620-SP	TN179387
SS-9151210-TP	TN179388
SS-2110710-TP	TN1700011
SS-4060310-SP	TN17003
MS-6680410-SP	TN17004
BTF0083	TN17005
BTF0084	TN17006

REECE	
REFERENCIA	CODIGO
01-1096	TN1493804
01-1124	TN1493802
01-2019	TN14921801
01-2084	TN1493801
01-2104	TN1493124
01-2193	TN1493125
01-2313	TN14921802
01-3054	TN1493803
01-3005	TN1493126
01-2341	TN1493127
01-2376	TN1493128
01-2305	TN1493129
01-2395	TN1493805
01-2334	TN1493806
01-2352	TN1493807
2196	TN1493808
01-1048	TN1493809
01-2131	TN1493810
01-1125	TN1493121
01-2386	TN1493122
01-2385	TN1493123
01-3025	TN149381

BROTHER	
REFERENCIA	CODIGO
100032-0-03	TN150011
117516-0-01	TN150002
144075-0-01	TN150001
146427-001	TN150801
147631-0-01	TN15091
062670612	TN150801
014680-4-22	TN150003
108960-0-02	TN150004
062681-0-12	TN150005
115166-0-01	TN150006

MAUSSER	
96700560-05	TN19000

YAMAT	
3637	TN2200091
4437	TN2240221
5345	TN2200801
9142	TN2200802
110004	TN2240222
110052	TN2200089

VARIOS	
REFERENCIA	CODIGO
	TN4099802
	TN4099803
	TN4099804
284	TN4099805
285	TN4099806
289	TN4099807
	TN4099801
CFS-2	TN4099809
CFS-3	TN4099808
CFS-4	TN40998010
CFS-5	TN40998011
91-17-91	TN2840401
91-13-62	TN28404011
24C1-3	TN4099811
SC18	TN4099810
M-051	TN71001
691	TN40998012
300C10-0004	TN4099812

U. SPECIAL	
87	TN2115011
187B	TN21011
22561	TN2115012
22798A	TN2115013
	TN2115010
88	TN21012

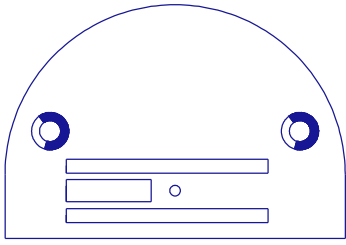

PAR-143175

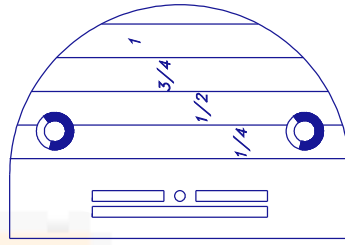

PAR-20123-LG

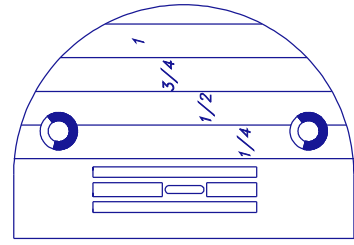

PAR-149233-LG

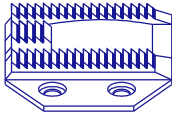

DR-143174

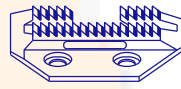

DR-149163

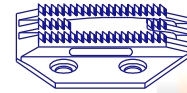

DR-149232



PAR-12438



PAR-143169

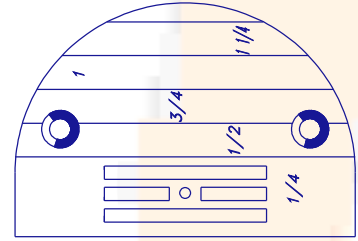

PAR-20160-LG



DR-12436

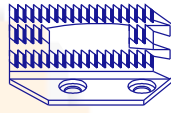

DR-149165

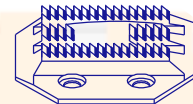

DR-149159

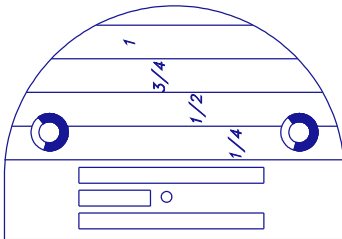

PAR-44162-LG

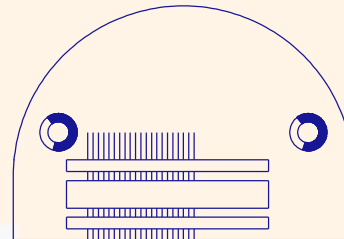

PAR-275020

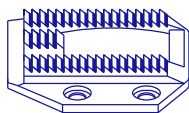

DR-44158

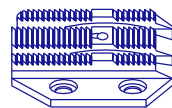

DR-275052
GENEROS FINOS

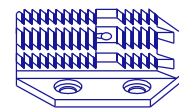

DR-275010
GENEROS LIGEROS

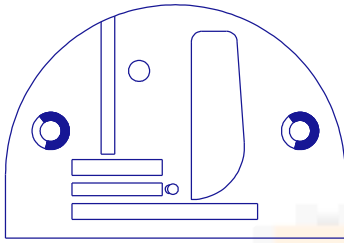

PAR-12442-B

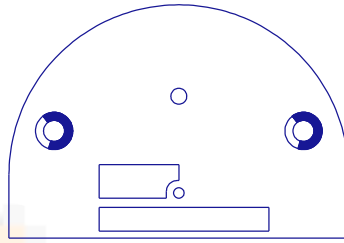

PAR-44137

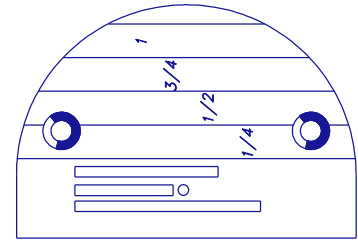

PAR-12482

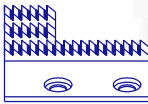

DR-20002

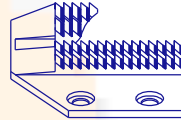

DR-44136

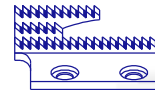

DR-12481



PAR-26272



PAR-26209



PAR-26096

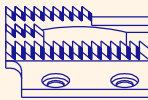

DR-26271

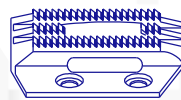

DR-26208

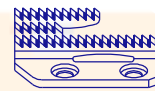

DR-26095

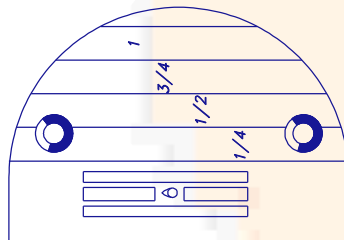

PAR-147150-LG ØMEDIO
PAR-147158-LG Ø PEQUEÑO
PAR-142061-LG ØGRANDE

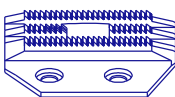

DR-272153
GENEROS MUY LIGEROS

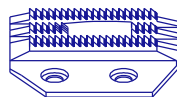

DR-149057
GENEROS LIGEROS

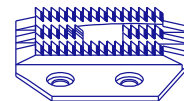

DR-149062
GENEROS MEDIOS



PAR-52033

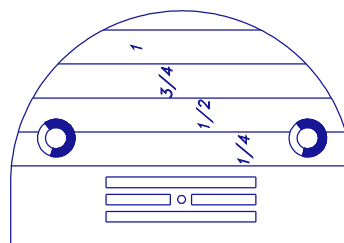

PAR-143272

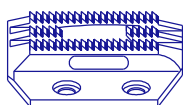

DR-52031

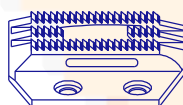

DR-149031

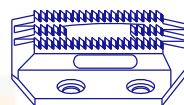

DR-52031

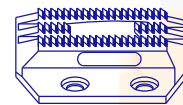

DR-149031

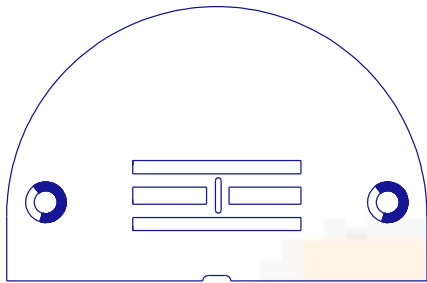

PA13001
327.026.031 (4,5 mm)
PA13005
327.008.031 (6 mm)

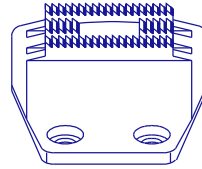

DT13001
328.032.032 (4,5 mm)
DT13005
328.011.032 (6 mm)

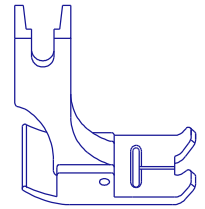

PS13001

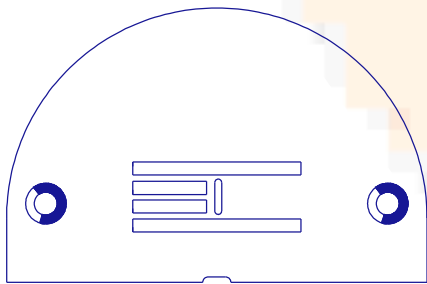

PA13003
327.120.030 (6 mm)

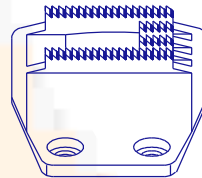

DT13003
328.014.032

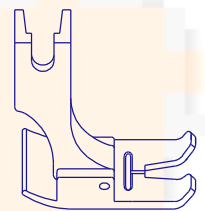

PS13003

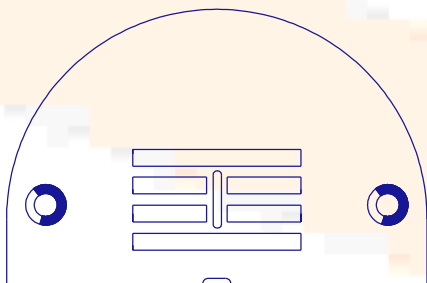

PA13002
327.014.030 (8 mm)

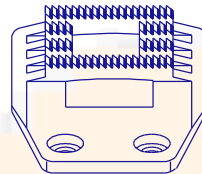

DT13002
328.016.032

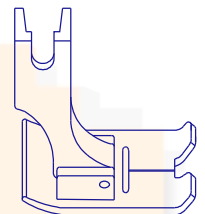

PS13002

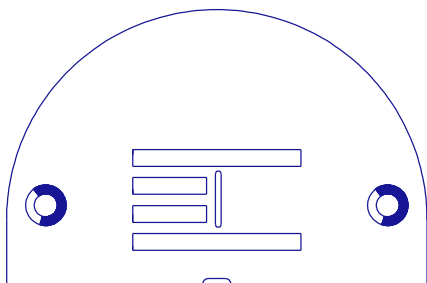

PA13004
327.034.030 (8 mm)

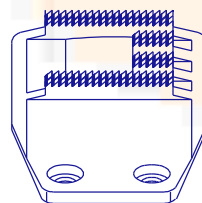

DT13004
328.039.032

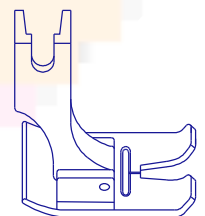

PS13004

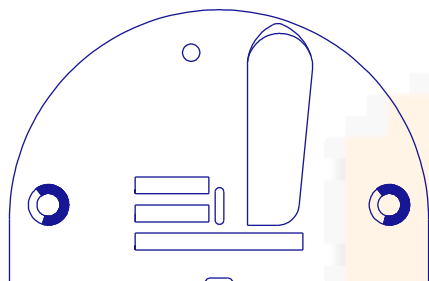

PA13006

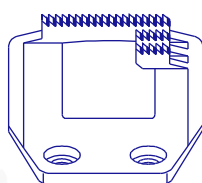

DT13006

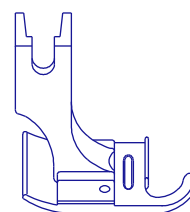

PS13006



PRENSATELAS FIJAR LÍNEA ELÁSTICA Y FRINCIR

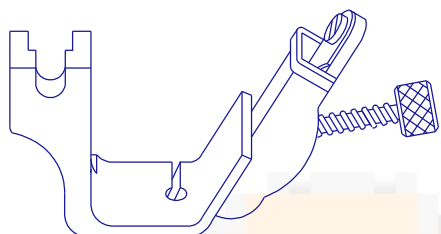

- PR-A227 1/8
- PR-A227 3/16
- PR-A227 1/4
- PR-A227 3/8
- PR-A227 1/2

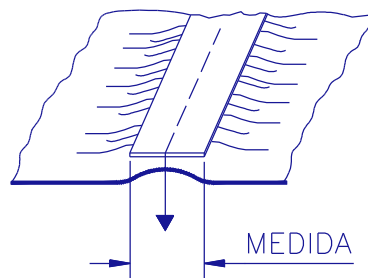

PRENSATELAS PARA CREMALLERAS

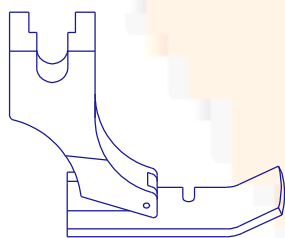

IZQUIERDA

DERECHA

- PR-P36LN ESTRECHO
- PR-P36L ANCHO

- PR-P36N ESTRECHO
- PR-P36 ANCHO

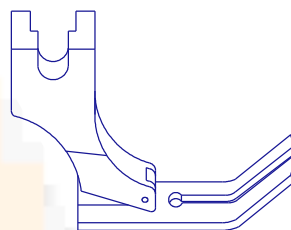

PR-P363V

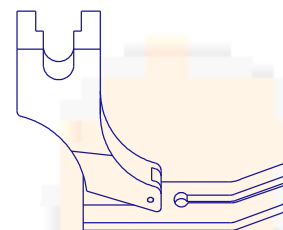

PR-P-363

PRENSATELAS CREMALLERAS TEFLÓN

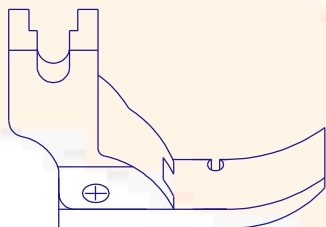

IZQUIERDA

- PR-T36LN 9/32
- PR-T36L 25/64

BASES

- T36LNB
- T36LB

DERECHA

- PR-T36N 9/32
- PR-T36 25/64

BASES

- T36NB
- T36B

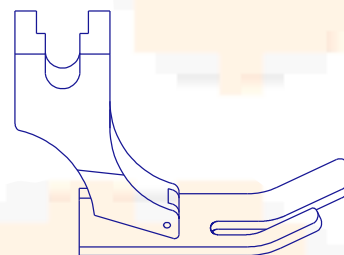

IZQUIERDA

DERECHA

PR-CP360

PR-P361



REF. 12036N (9/32) ANCHO FILO DERECHA



REF. 12036N (9/32) LÍNEA ELÁSTICA Y FRINCIR DERECHA



REF. 12036L (25/64) ANCHO FILO DERECHA



REF. 12036N (9/32) ANCHO FILO DERECHA



REF. 12033 (9/32) LÍNEA ELÁSTICA Y FRINCIR DERECHA
REF. 12033 (9/32) BASE

PRENSATELAS DE TUBO PARA FIJAR CINTA



REF. 12035 (9/32) ANCHO FILO DERECHA
REF. 12035 (9/32) BASE



PRENSATELAS ORILLADOR

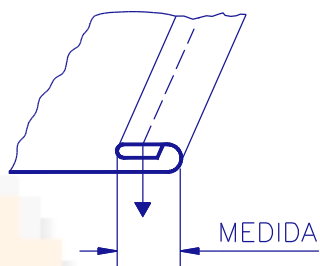
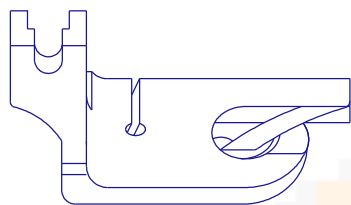

REFERENCIA

PR-160344	1/16
PR-120937	5/64
PR-120938	3/32
PR-120803	1/8
PR-120804	5/32
PR-120805	3/16
PR-120940	7/32
PR-120806	1/4
PR-120807	5/16
PR-12095	1/16
PR-120808	3/8

PRENSATELAS ORILLADOR

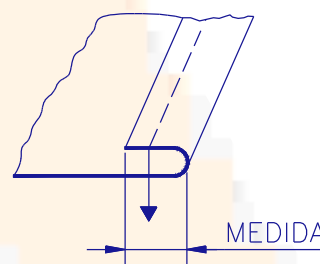
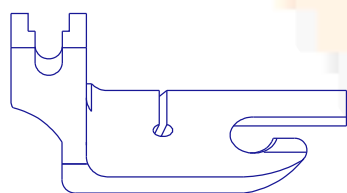

REFERENCIA

PR-P25	3,2	1/16
PR-P4	4,8	3/16
PR-P46	6,6	7/32
PR-P6	6,4	1/4
PR-P75	8,0	5/16
PR-P9	9,5	3/8

PRENSATELAS ORILLADOR



REF	Medidas
H5019	4.80mm 3/16"
H5013	3.20mm 1/4"
(490355)	

PRENSATELAS ORILLADOR

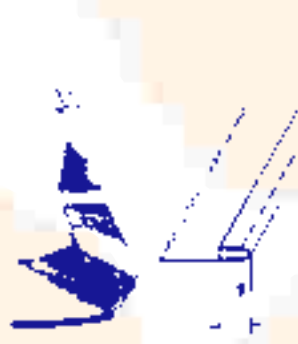

REF	Medidas
H5017 (490357)	4.80mm 3/16"
	3.40mm 1/4"



REF	Medidas
H5020	4.80mm 3/16"
H5020	3.40mm 1/4"



REF	Medidas
H5019H	4.80mm 3/16"
H5019H	6.40mm 1/4"
(490356)	

PRENSATELAS DOBLADILLADOR DE ALAMBRE



REF	Medidas
H5018 (490358)	1.60mm 1/16"
	3.20mm 1/8"
	4.60mm 3/16"
	6.40mm 1/4"

PRENSATELAS DOBLADILLADOR DE BOLA



REF	Medidas
H6010 (490358)	1.60mm 1/16"
	3.20mm 1/8"
	4.80mm 3/16"
	6.40mm 1/4"

PRENSATELAS ARRASTRE SIMPLE ASIMETRICO

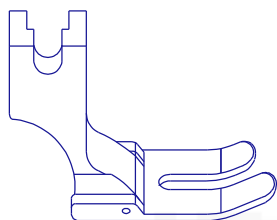

- PR-P-35 NORMAL
- PR-142058N ESTRECHO
- PR-P-351 ANCHO. COLA TRASERA ELEVADA
- PR-P-193 ANCHO
- PR-P127 SUPER ANCHO. PUNTAS ELEVADAS (127233)

PRENSATELAS ARRASTRE SIMPLE SIMETRICO



- PR-142058W-MEDIO
- PR-12144H-ANCHO BASCULANTE
- PR-12144-ANCHO FIJO

PRENSATELAS APLANAR DOBLADILLOS Y EMBUDO RIBETEAR

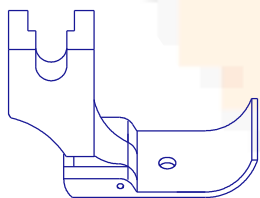

SIN GUIA

CON GUIA IZQUIERDA

- PR-3613 9/32 PR-P3811 15/64
- PR-3619 1/2 PR-P3819 1/2"
- PR-3625 3/4 PR-P3825 3/4"

PARA EMBUDOS RIBETEAR

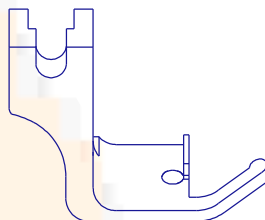

- PR-12142C-3/4
- PR-12142C-7/8
- PR-12142C-1/8
- PR-12142C-1/4
- PR-12142C-1/2
- PR-12142C-1
- PR-12142C-1 1/2
- PR-12142C-1 1/4

PRENSATELAS BASCULANTE DE TEFLÓN Cola trasera elevada



- REF. P-351-T
- REF. P-351T-B
- BASE DE TEFLÓN

PRENSATELAS PARA EMBUDOS S60 (A-10)



- REF. S643 (CB 3-4)
- PARA EMBUDOS DE 16 A 24mm
- REF. 602 (CB 1)
- PARA EMBUDOS DE 26 A 32mm
- REF. 504 (CB 1')
- PARA EMBUDOS DE 36 A 50mm

ENCAJE TIPO SINGER-TEFLÓN DOBLES



PRENSATELAS FIJO MEDIO PATIN



- REF. 12143 (P983)

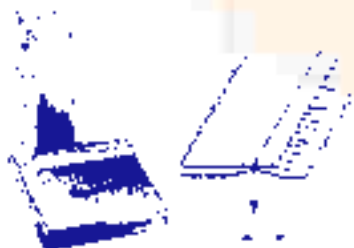

- REF. P5 5mm 3/16"
- REF. P5W 10mm 13/32"
- PARA FRUNDIR Y UNIR

PRENSATELAS

REF.	Medidas	
MT 23D	0.80mm	1.32"
MT 230D	0.80mm	1.32"
ESTRECHO		
MT 231D	1.60mm	1.16"

BASES

REF.	Medidas	
MT 23DB	0.80mm	1.32"
MT 230DB	0.80mm	1.32"
ESTRECHO		
MT 231DB	1.60mm	1.16"

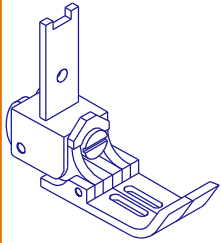

112WC9

MEDIDAS

- 3/16"
- 1/4"
- 5/16"
- 3/8"

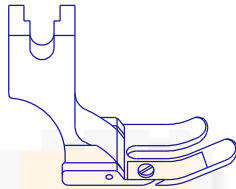

PR-APP

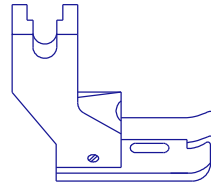

REFREY
PR-9224000-2

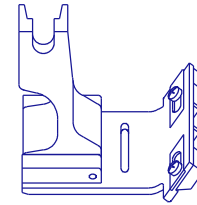

438AA

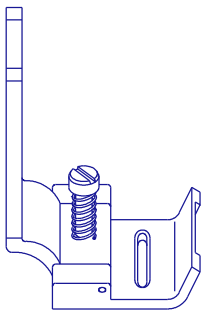

PF-DG9

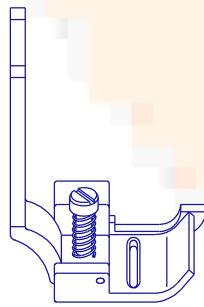

PF-AIR

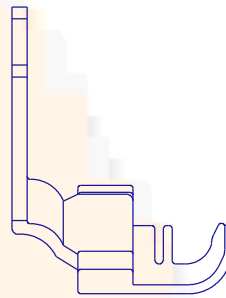

PR-210569B

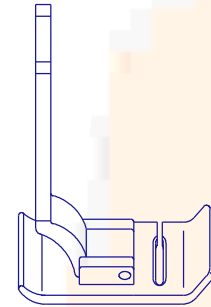

PR-503595

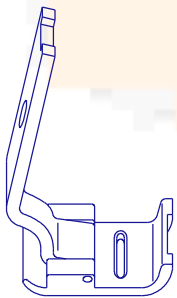

457DGF-10

MEDIDAS

- 10 mm
- 12 mm
- 13 mm
- 15 mm

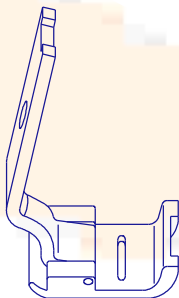

457DG-10

MEDIDAS

- 10 mm
- 12 mm
- 13 mm
- 15 mm

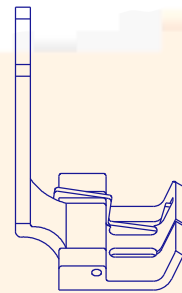

DERECHA

- PR-S570-1/8
- PR-S570-3/16
- PR-S570-1/4
- PR-S570-5/16
- PR-S570-3/8

IZQUIERDA

- PR-S570L-1/4
- PR-S570L-3/16

DOBLE

- PR-S570DG-1/4
- PR-S570DG-3/16

PRENSATELAS PASAR AROS

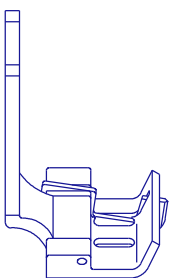

S570AR

MEDIDAS

- 1/8"
- 5/32"
- 3/16"
- 1/4"
- 5/16"

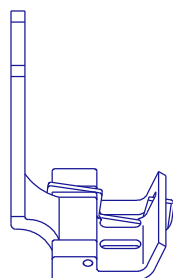
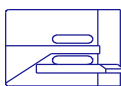

S570AL

MEDIDAS

- 1/8"
- 5/32"
- 3/16"
- 1/4"
- 5/16"

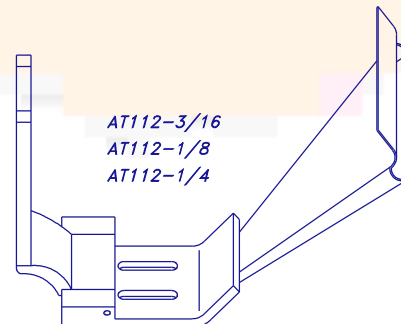
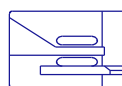

AT112-3/16
AT112-1/8
AT112-1/4



ADLER

**068 15 081 4
HAD-68**



MAQUINA
067;068

**069 00 581 4/ 069 15 027 4
HPF-335(5)**



MAQUINA
069;501

**098 15 007 4/ 252 781
DP2/DP2-L(N)**



MAQUINA
91;98
252;253;254;255;264

**167 00 181 4
HAD-167**



GRAN CAPACIDAD

MAQUINA
167;168
267;268

169 00 181 4



GRAN CAPACIDAD

MAQUINA
169;269

**396 15 281 4
HAD-396
HAD-196B**



MAQUINA
196;296;396

**220-181-4
HSH-445**



MAQUINA
220

**265-21-142
HSH-32**



MAQUINA
265

**467 15 009 4
HAD-467TR(Cortahilos)**



GRAN CAPACIDAD

MAQUINA
467;767

**467 15 001 4
HAD-467**



GRAN CAPACIDAD

MAQUINA
467;767

467 15 085 4/ 467 15 080 4







GRAN CAPACIDAD

MAQUINA
767

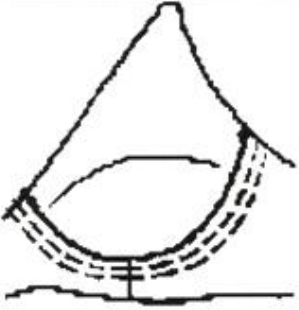
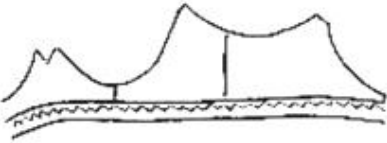
	22185 & 22223 23770 21010 224053, 224029 23061 23071 23207 24711 KHF63	9 4 17 18 20 20 22 22 24
	503733N & 503734N 51768 & 417920 503605 & 541647 107-029 107-G5L 23769 23781 107-4L, 107-5L, 107-6L 266125, 3706, 3707 210562A, 210516A, 210596A 212-005A 212-112 23072 KHF81 SP-18N KHF83	1 3 3 4 4 4 6 7 8 12 19 19 21 26 28 28
	21010 224053, 224029 212-112K 23069 23073 24711 21139 KHF71	17 18 19 20 21 22 23 25
	23061 KHF63 KHF96, 212-96	20 24 27
	21010 212-005A 212-112 23071 23073	17 19 19 20 21



	21010 23388 21014 224053 & 224029 223884H & 223628H 23061 223733 23207 24711 21140 KHF38, KHF63 KHF68, KHF71, KHF77 KHF78, KHF92 KHF97	17 17 17 18 18 20 21 22 22 22 24 25 26 27
	107C 51768, 417920 107-G5L 23766A 23769 23771, R23771 23772 23779, 23780 23782 23425 603766 KHF36 457-188, 457T1, 457T2, KH457-T1, KH457-T2	2,5 3 4 4 4 2,5 5 5 6 6 6 10 13 13
	KHF36 KHF47 KHF59 KHF76 KHF79 210569-A, 210569-B 210562A, 210516A, 210596A K10 KHF57, KHF62,	10 10 10 11 11 11 12 28 29
	23766A 23771, R23771 23782 23425 603766 457-188, 457T1, 457T2, KH457-T1, KH457-T2 KHF57, KHF62	4 2,5 6 6 6 13 13 29
	107-086 107-254 107B 210603 & 210523 210604 & 210524 107-CL 107-DL, 107-DR 266125, 3706, 3707 231-12551	1 1 1 2 2 7 7 8 9



107-086

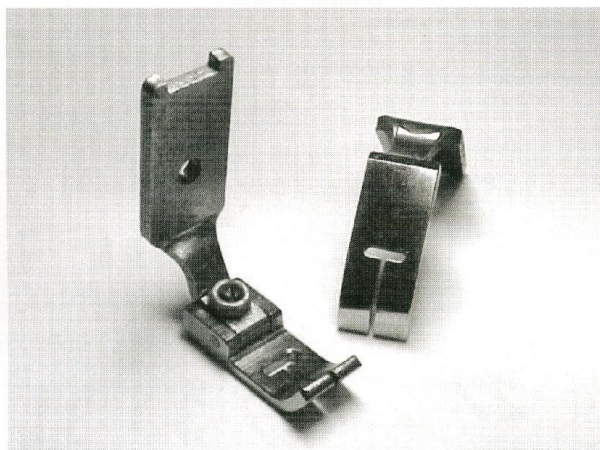

Prensateles ancho 10 mm

107-254

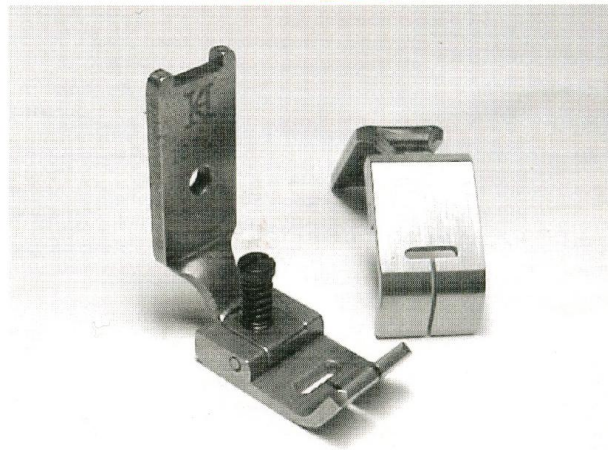

Prensateles ancho 14,5 mm

107A

210569

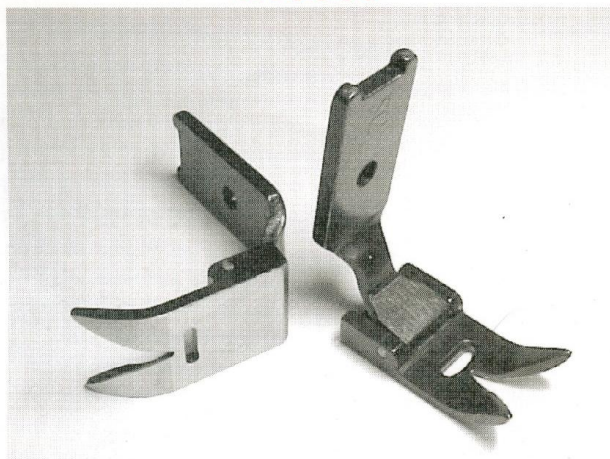

Prensateles ancho 15 mm

210600

210518

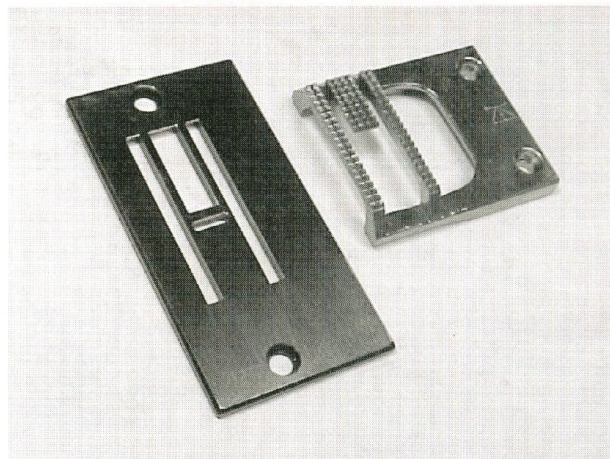

Placa agujas 6,9 mm / Diente 13,3 mm

107B

241375

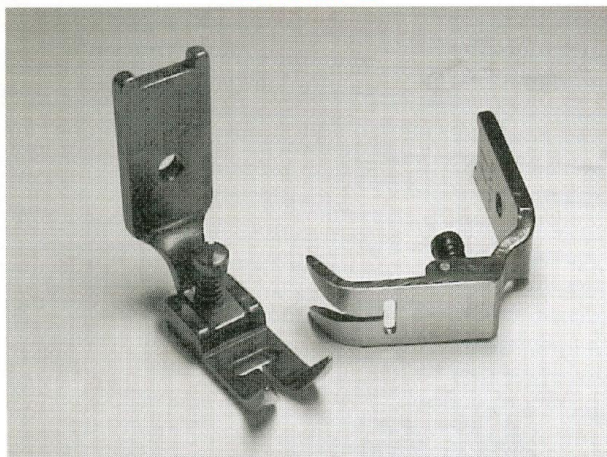

Prensateles ancho 11 mm

503733N

503734N

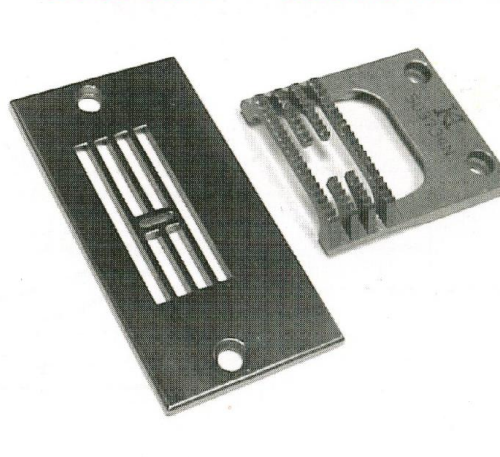

Placa agujas 6 mm / Diente 13,5 mm



107C

23771

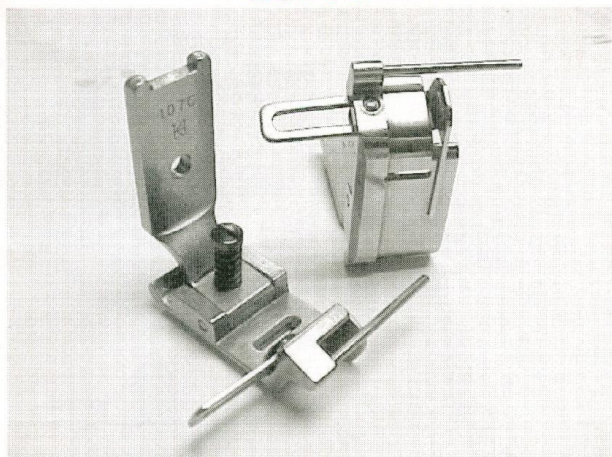

Prensateles con guía ajustable

210603

210523

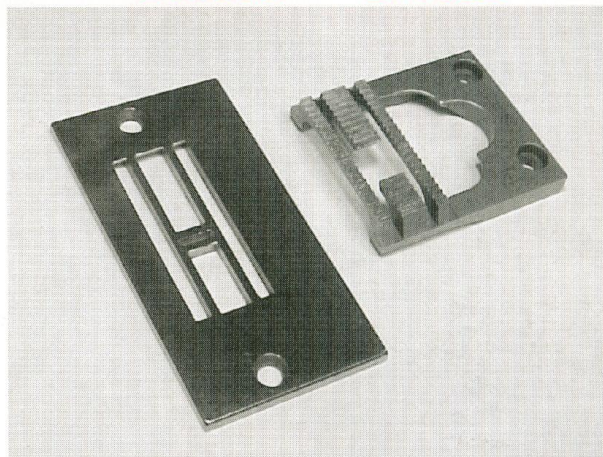

Placa agujas 6 mm/ Diente 13,5 mm

210604, 210524

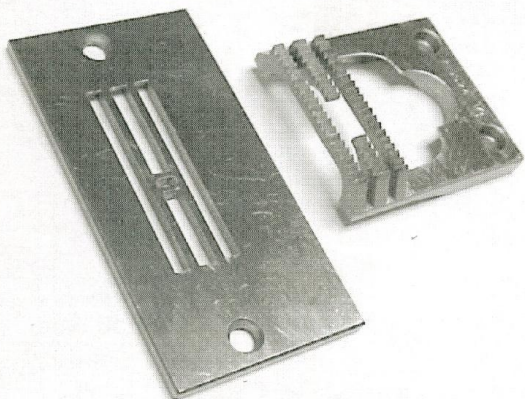

Placa agujas 3x1,2 mm / Diente 10,5 mm

411314

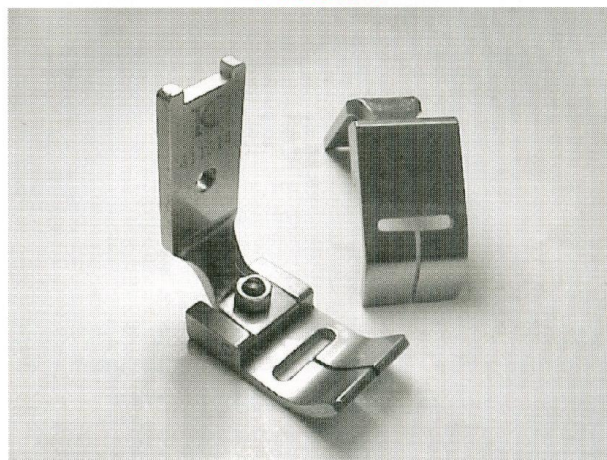

Prensateles 17 mm

503595

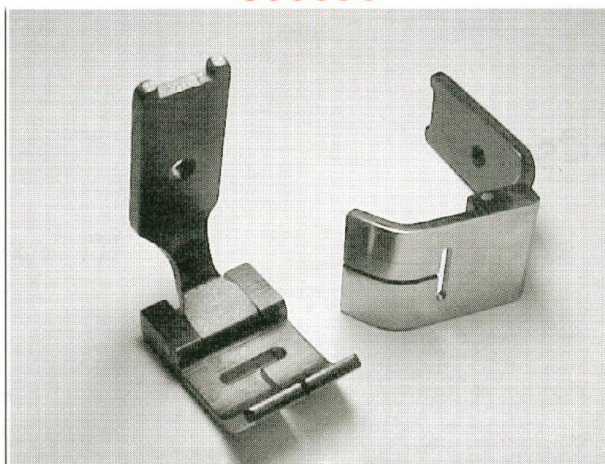

Prensateles 18,7 mm



503689

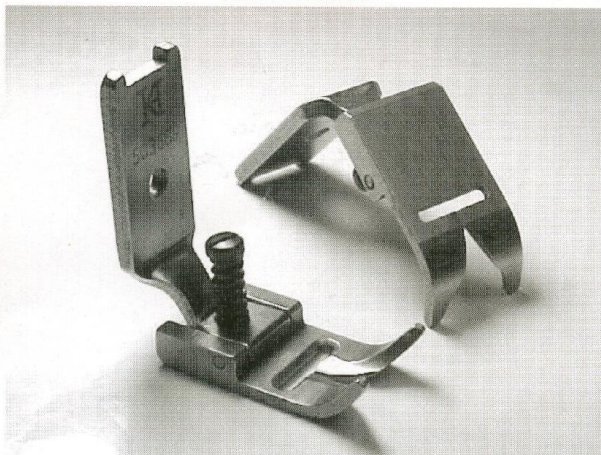

Prensateclas 16 mm

503690

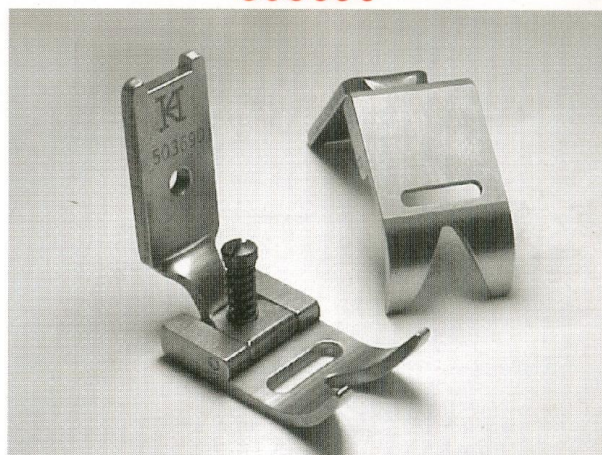

Prensateclas 19 mm

51768-L 417920-L

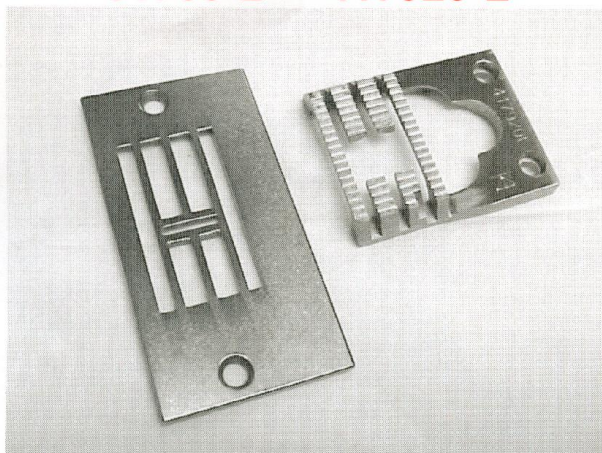

Placa agujas 10,3 mm
Dientes 17,5 mm
Espacio: 5T + 8T

51768-S 417920-S

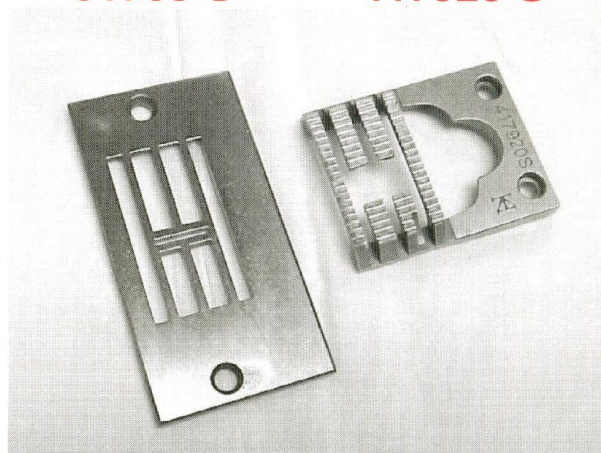

Placa agujas 10,3 mm
Dientes 17,5 mm
Espacio: 6T + 9T

51768-SN 417920-SN

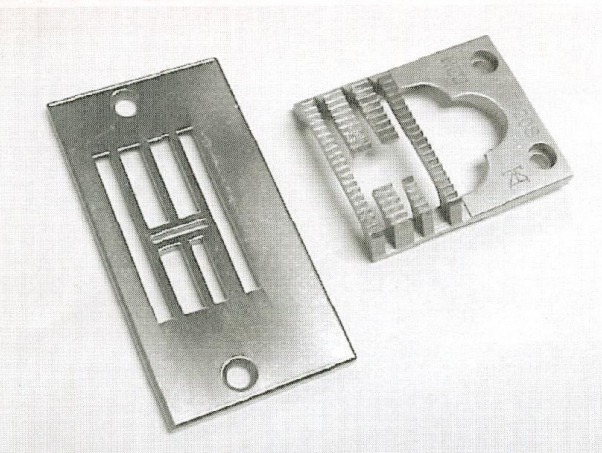

Placa agujas 10,3 mm
Dientes 17,5 mm
Espacio: 6T + 9T

503605 541647

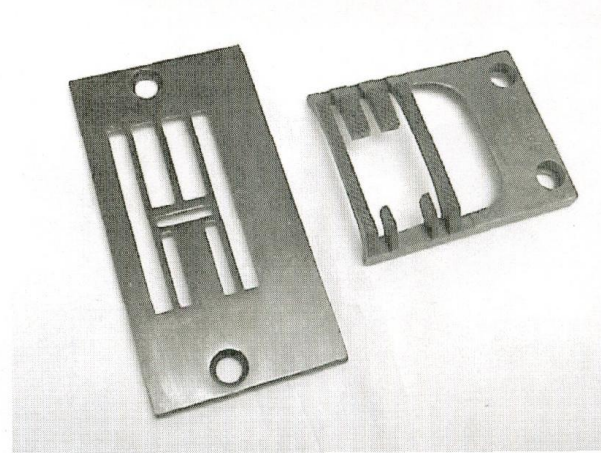

Placa agujas 10 mm
Dientes 17,5 mm
Corte diamante



107-029

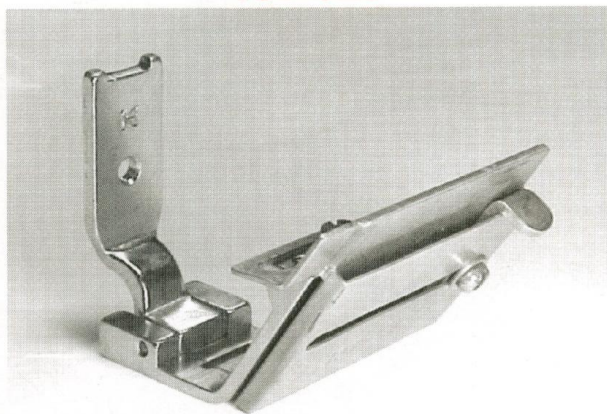

Prensateles con guía. Máx. 34 mm

107-G5L

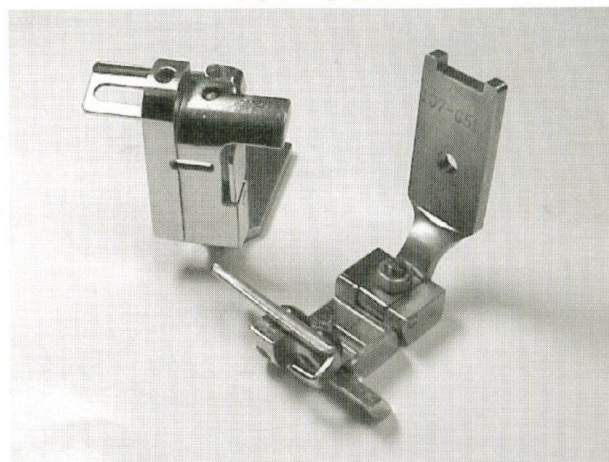

Prensateles con guía para goma. 7mm-17 mm

23766A (457GB)

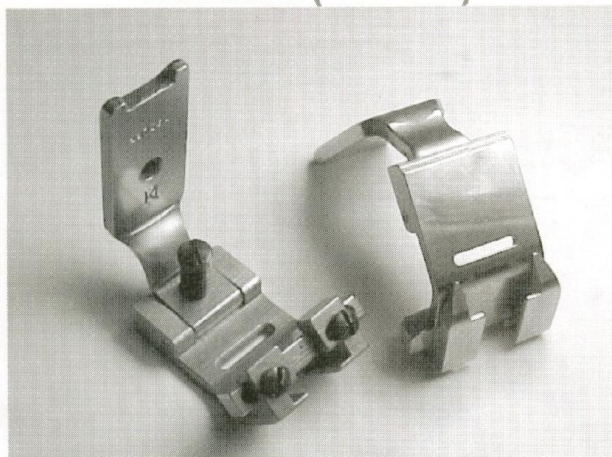

Prensateles con guía para goma. 5mm-18 mm

23769

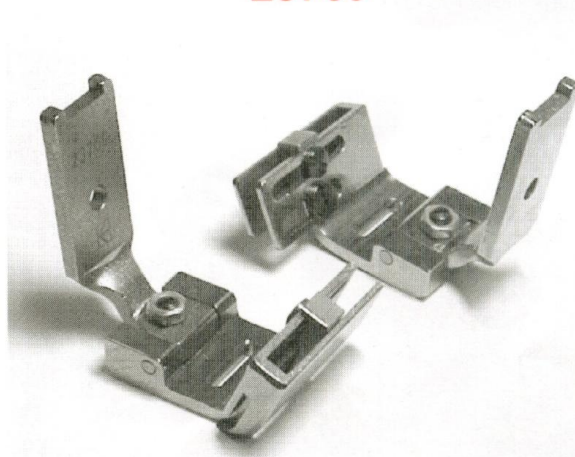

Prensateles con guía para goma. 7mm-20 mm

23770

Prensateles con guía para cinta.
Entrada: 5/8 " Salida 5/16 "

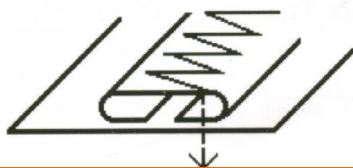
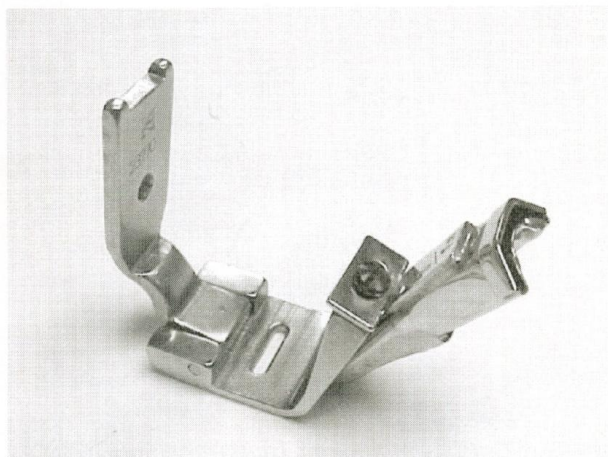

23770K

Prensateles para abrir costuras.
Entrada: 5/8 " Salida 5/16 "

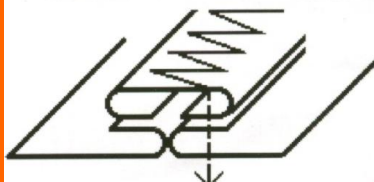
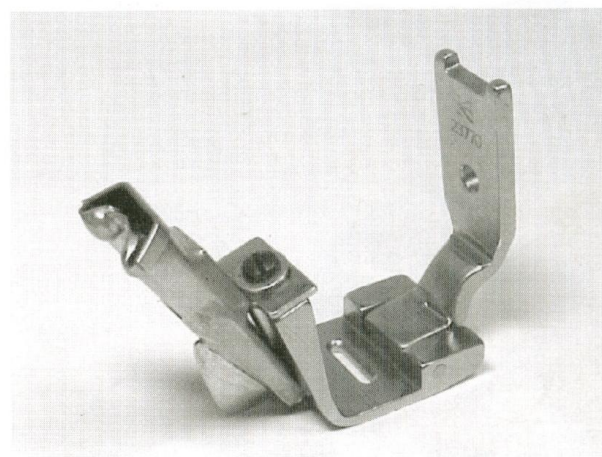

23771 (107C)

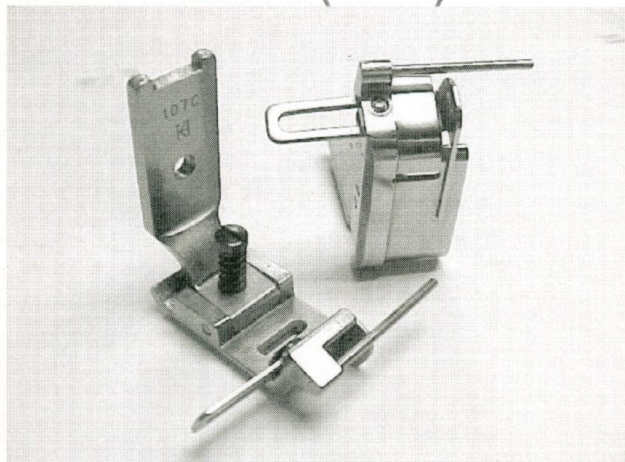

Prensateles para poner goma. 7,4 mm-21,5 mm

R23771

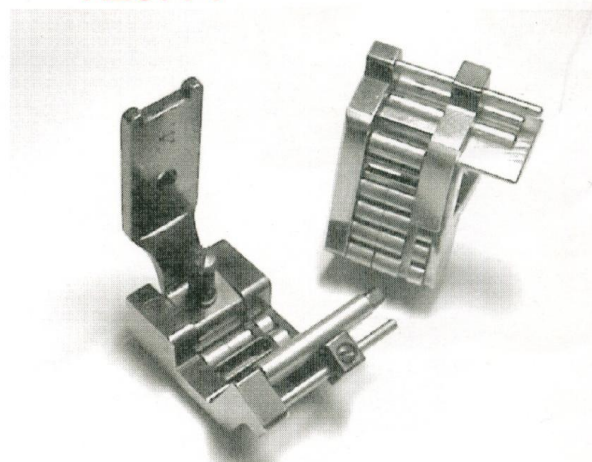

Prensateles para poner goma. Máx. 20 mm

23772 (107E)

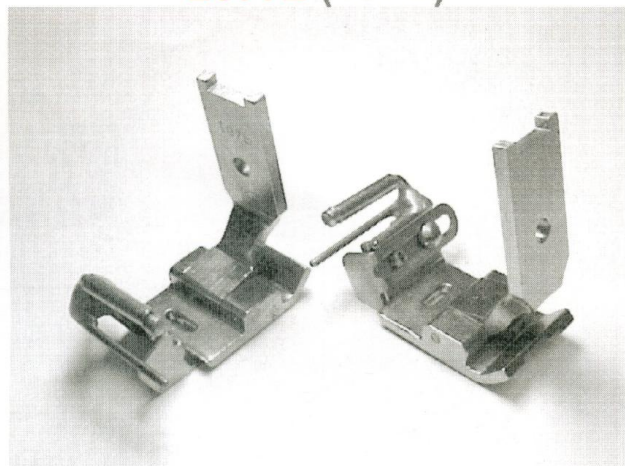

Prensateles con guía para puntilla elástica.
Máx. 16 mm

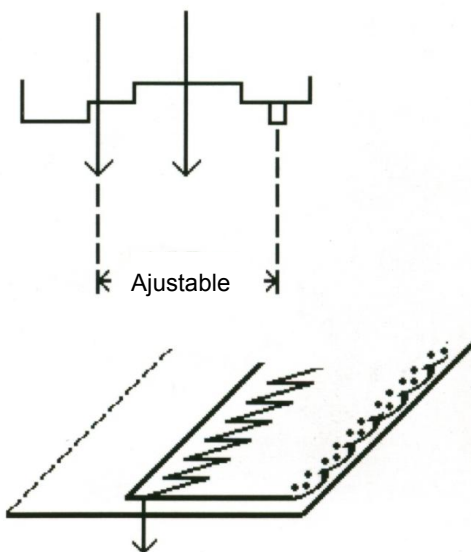

23779 (457A)

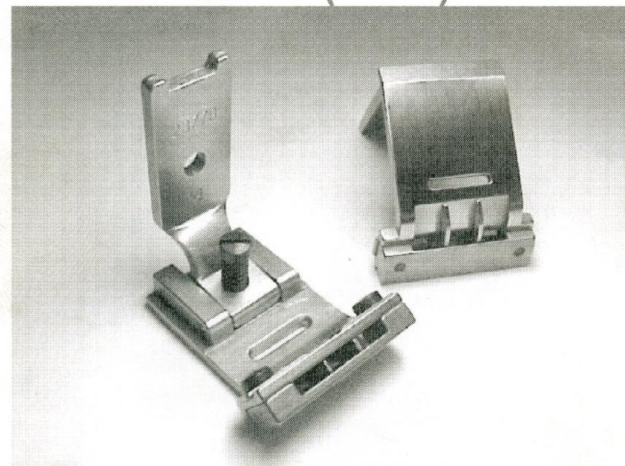

Prensateles para puntilla elástica. 4 mm-15 mm

23780 (457A1)

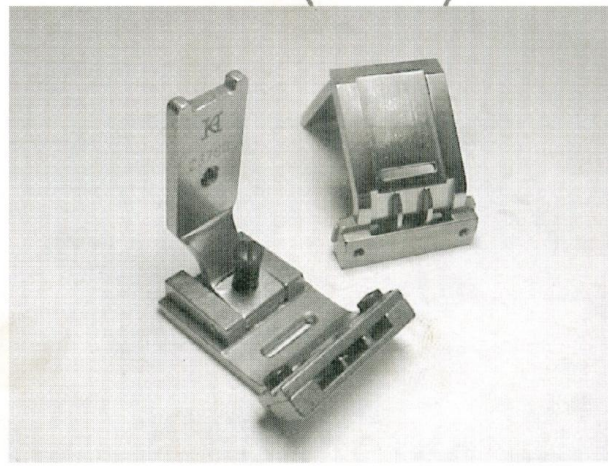

Prensateles rebajado para poner cinta. 5 mm-14 mm



23781

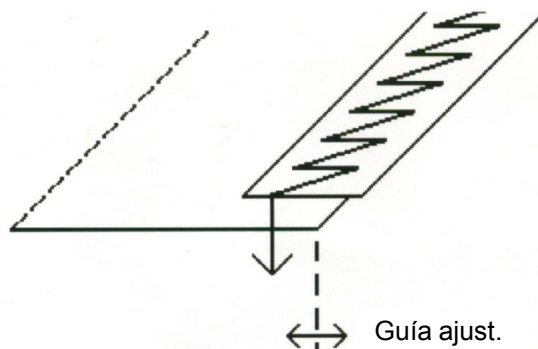
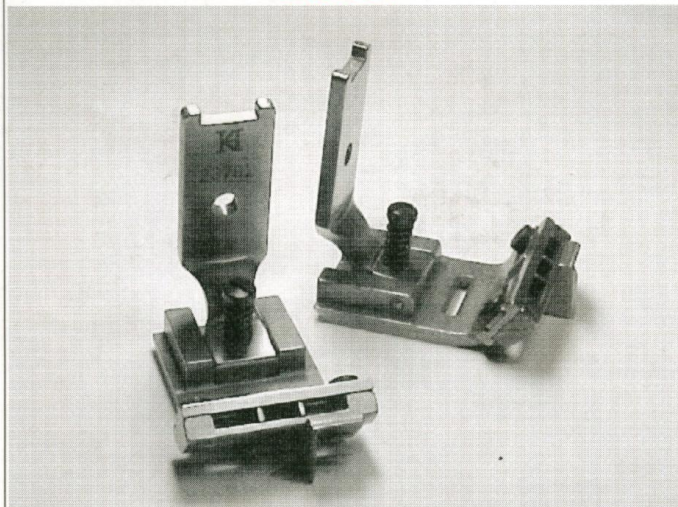

Prensateles con uña ajustable. 5mm-17 mm

23782

Prensateles con guía ajustable

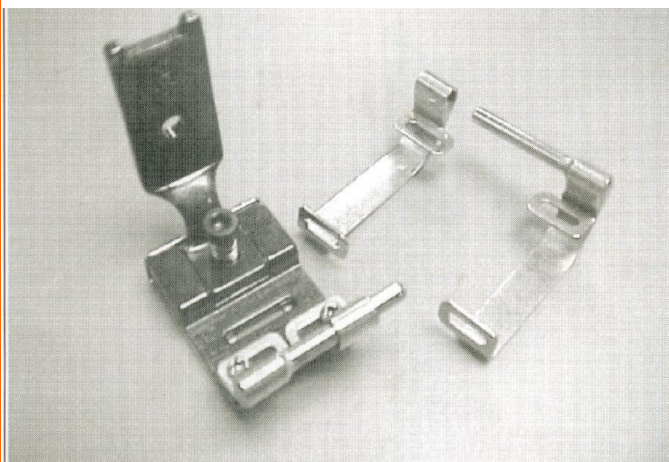

23782 Prensateles
23782-G Guía ajustable

23425

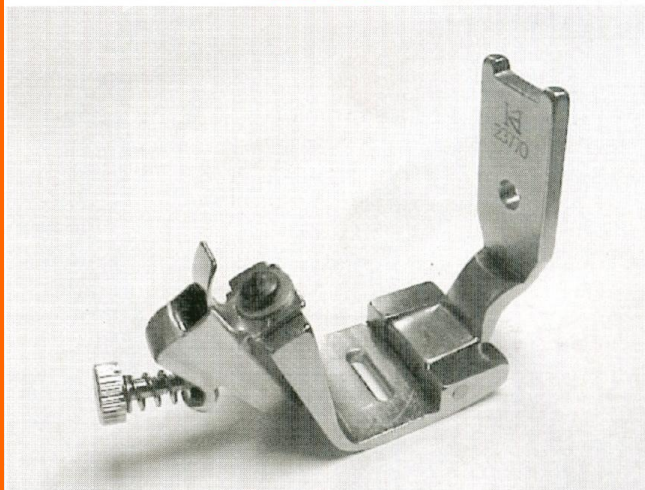

Prensateles para fruncir.
Entrada; 1/8", 3/16", 1/4", 3/8", 1/2"

603766

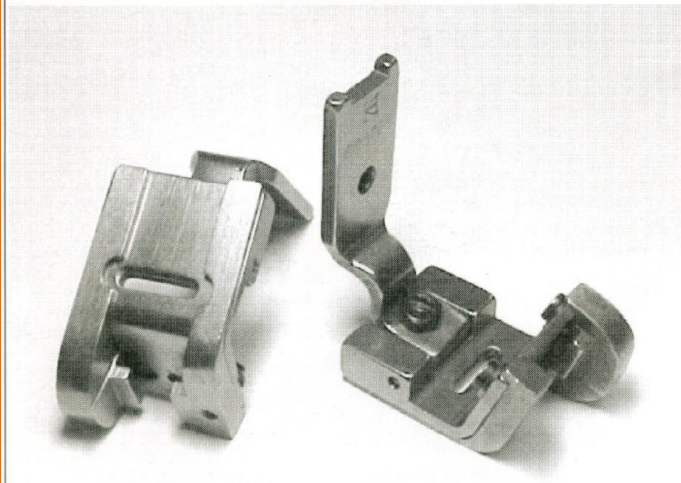

Prensateles para poner cinta ajustable

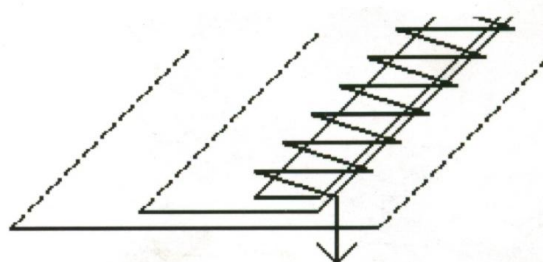

107-4L

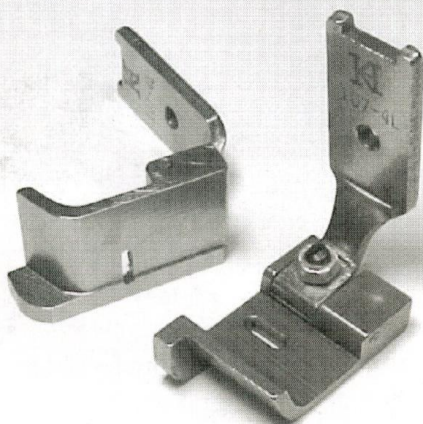

Prensateles 18 mm

107-5L

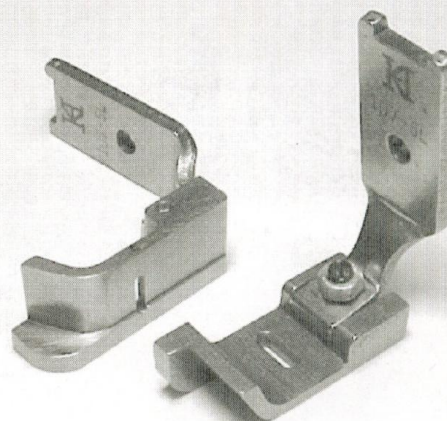

Prensateles 13,3 mm

107-6L

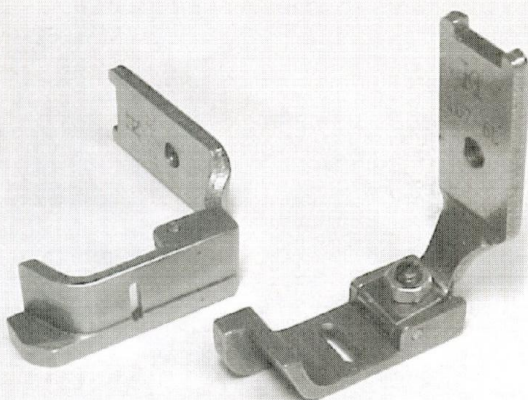

Prensateles 11,6 mm

107-CL

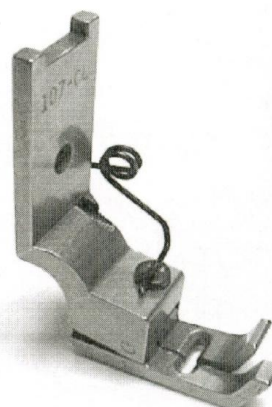

Prensateles compensado a la izquierda

107-DL

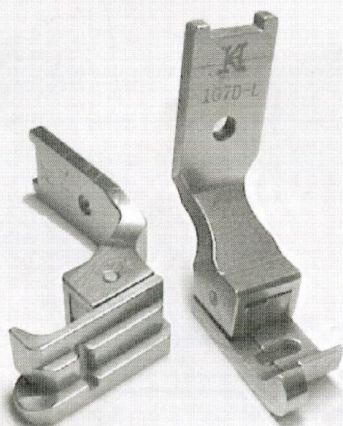

Prensateles compensado a la izquierda

107-DR

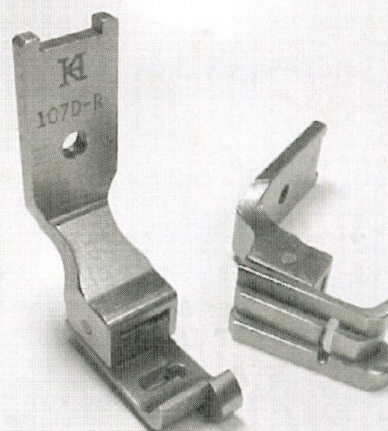

Prensateles compensado a la derecha



23768 (107K)

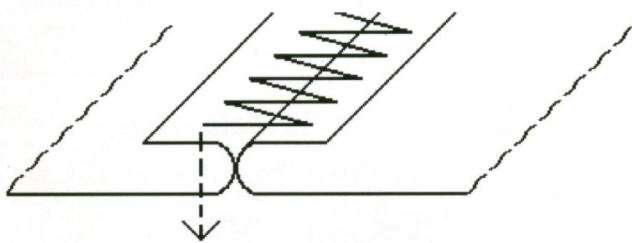
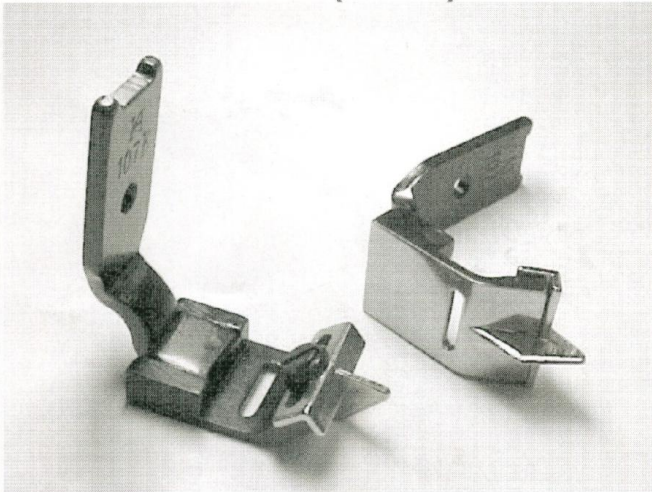

Prensateles con guía central para abrir costuras

266125

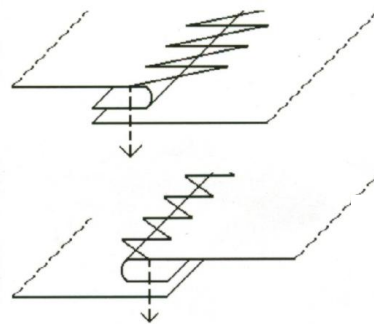
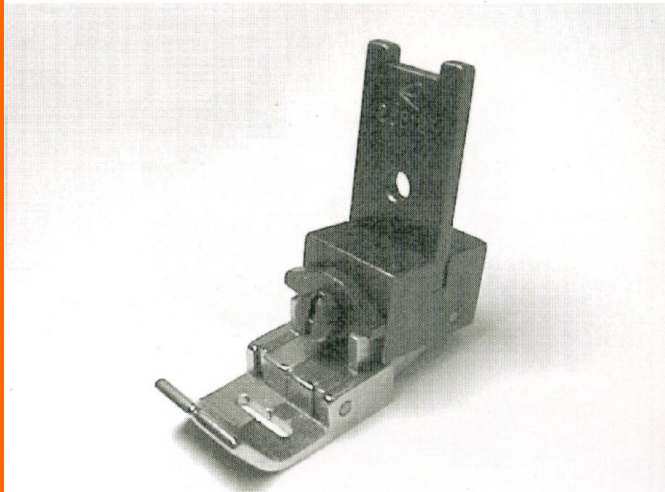

Prensateles compensado doble

3706

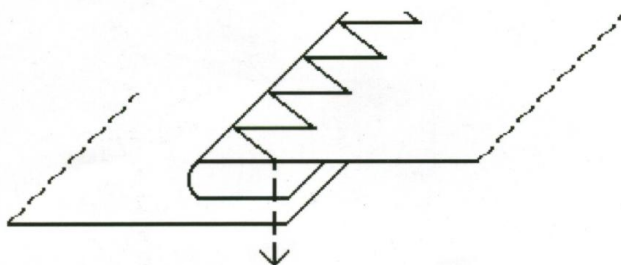
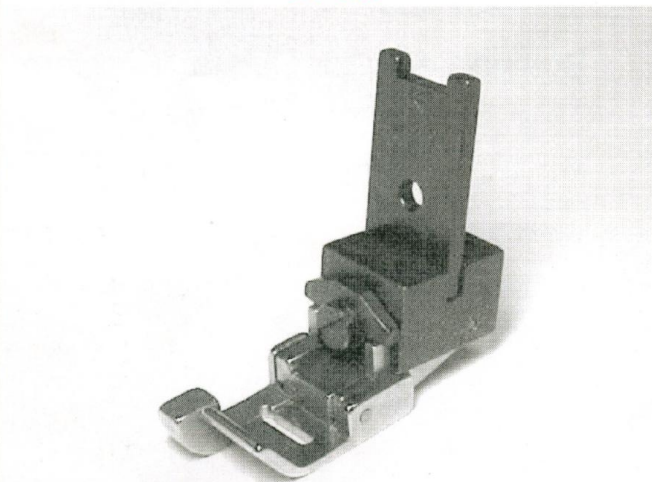

Prensateles compensado izquierda

3707

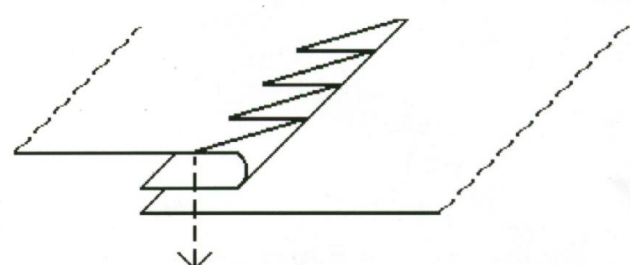
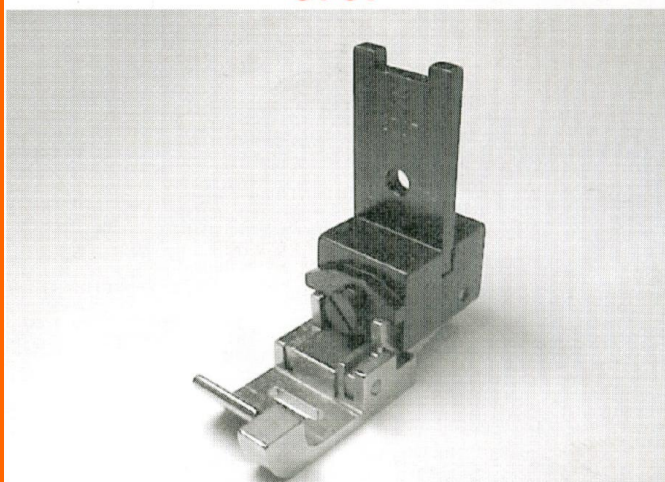

Prensateles compensado derecha



457-CL

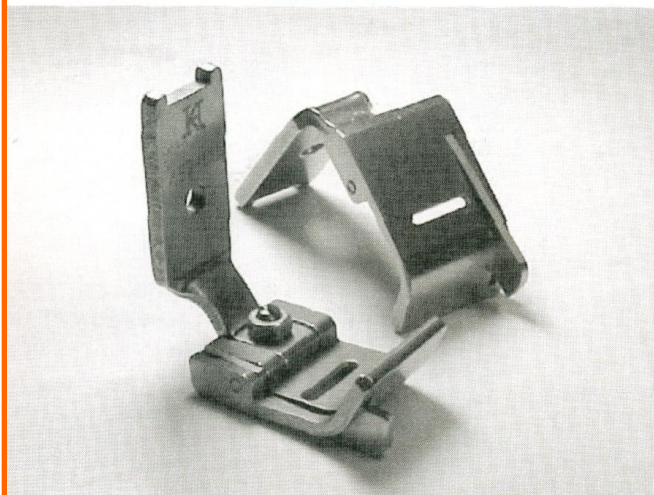

Prensateles con tope compensado izquierda

457-CR

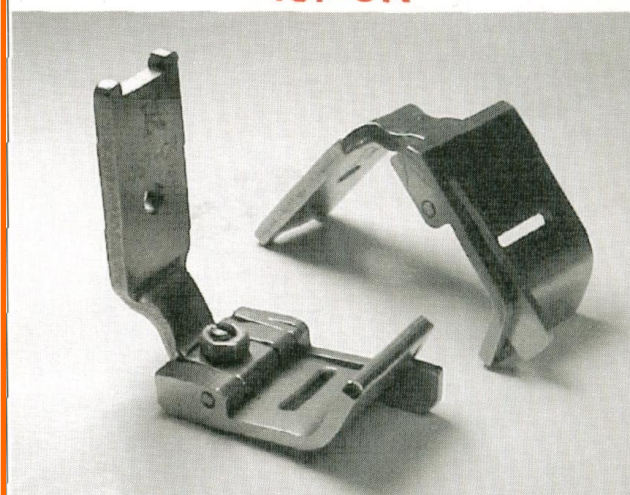

Prensateles con tope compensado derecha

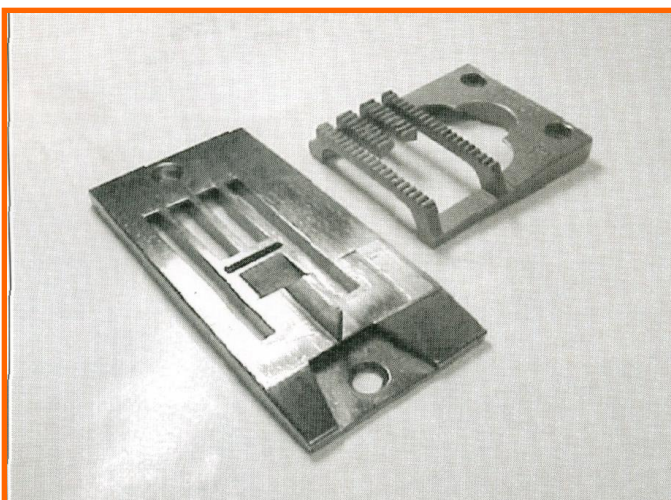

22185 Placa agujas

22223 Dientes

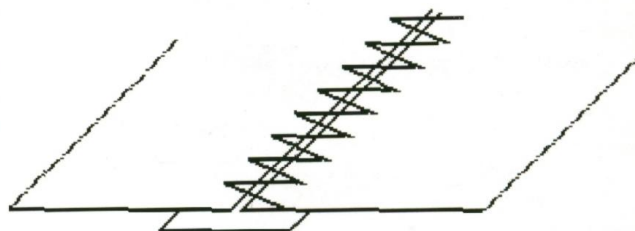

Juego para hacer la costura de la copa del sujetador

235-12551

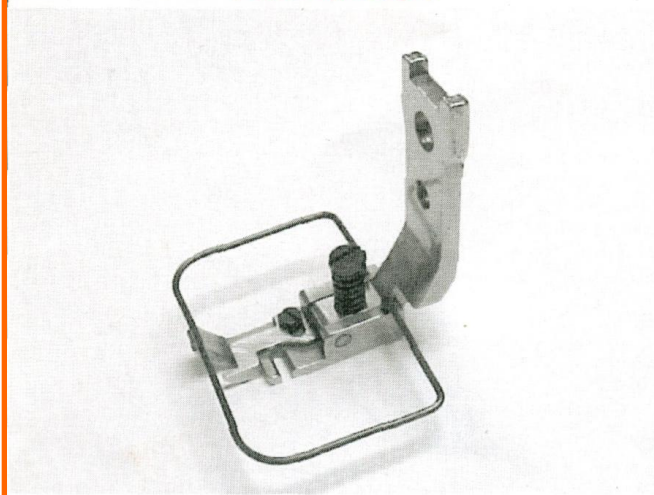

Prensateles para poner cierres sujetador

503818

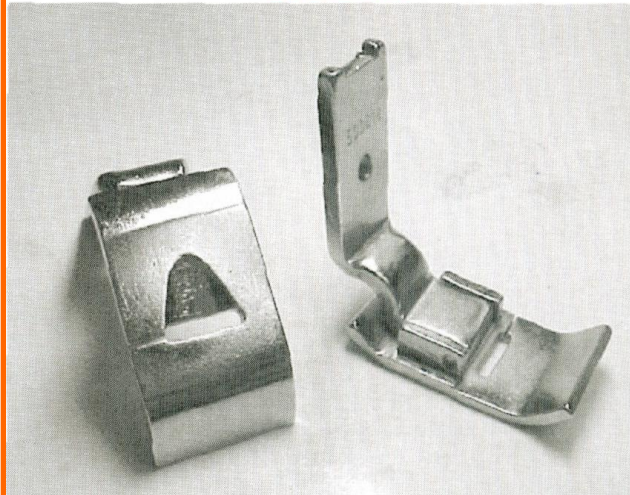

Prensateles

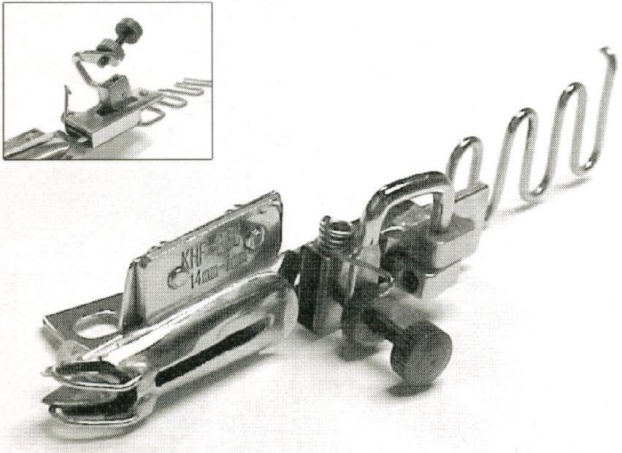
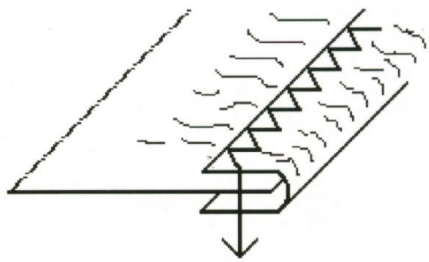

KHF36 Guía para poner goma

Entrada: 1/2", 5/8", 14 mm

KHF47 Guía tope ajustable doblando a un lado

Ajustable

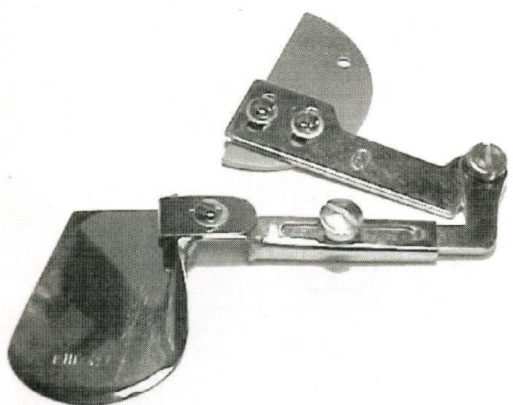
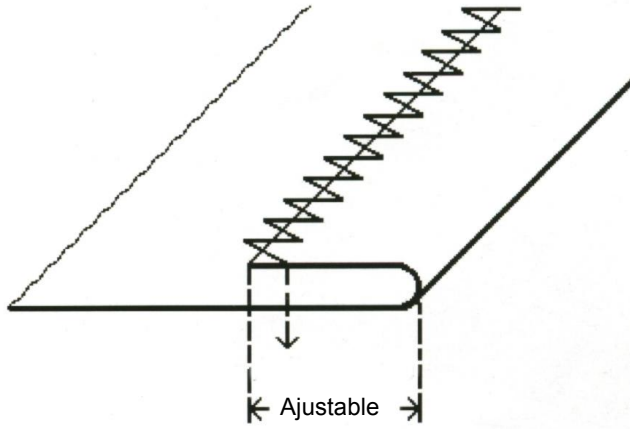
KHF59
Juego ribetear con guía boras

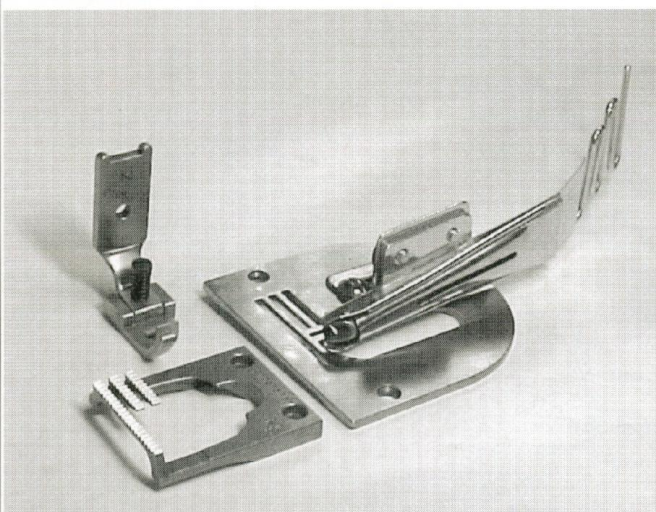

	Doblando un lado. 1/2" - 3/16" 3/4" - 1/4"
	Doblando dos lados. 1 - 1/4" 3/4" - 3/16"
	Doblando por la mitad 1/2" - 1/4" 5/8" - 5/16"



KHF76

Guía

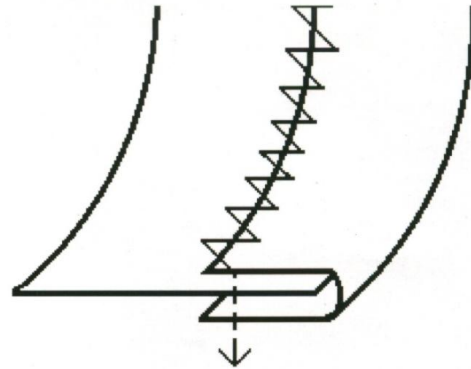
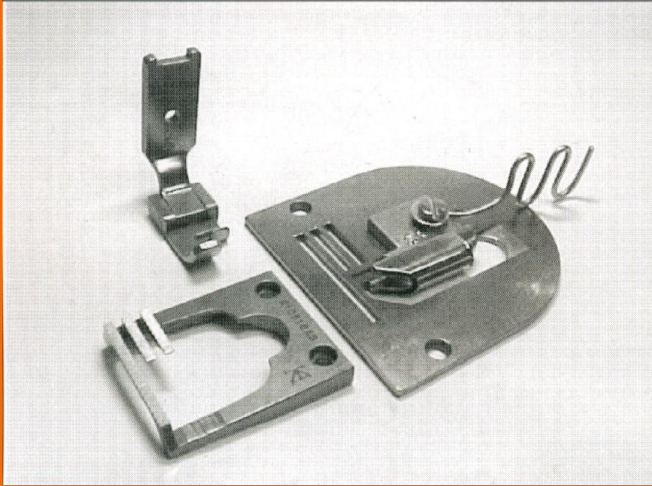

Salida: 5.2mm, 6.4mm, 8mm

KHF79

Guía

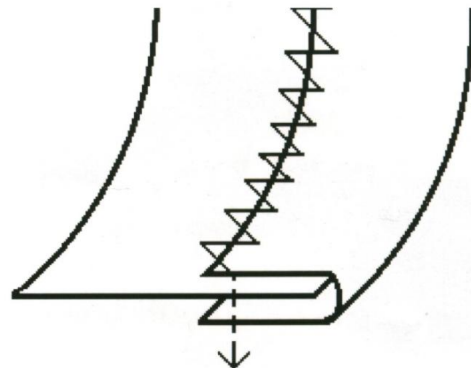
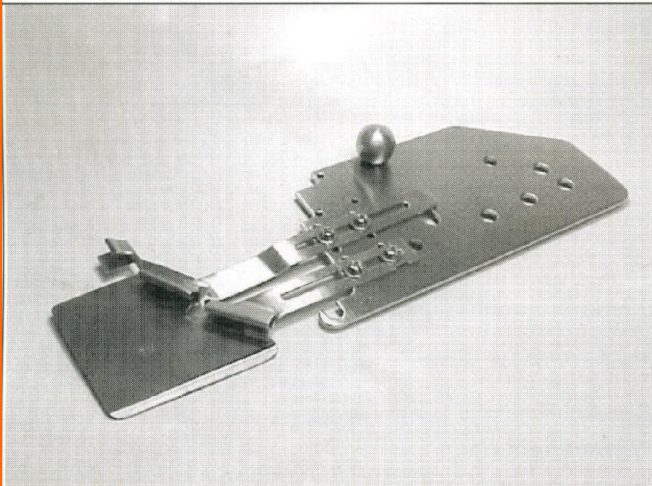

210569-A

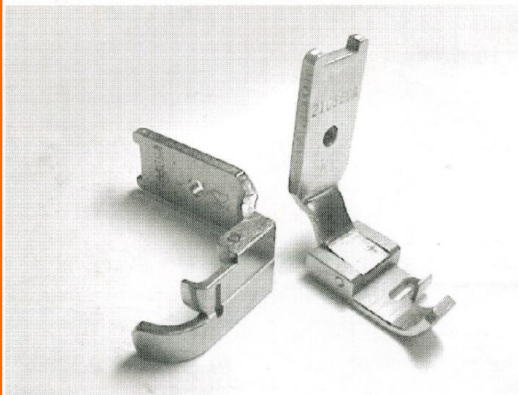

Prensateles 13 mm

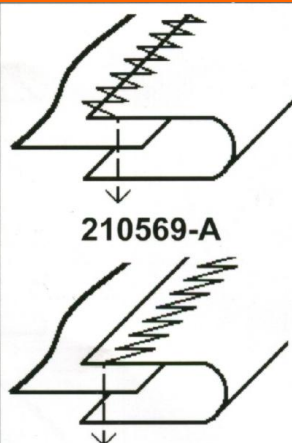

210569-A

210569-B

210569-B

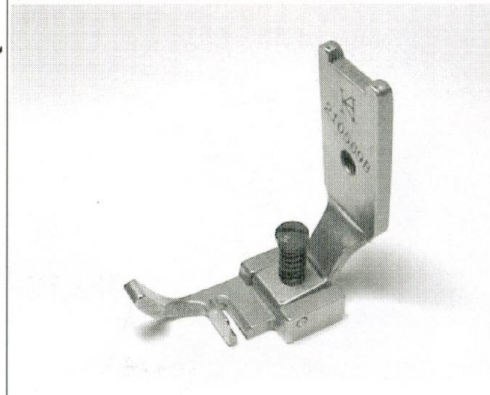

Prensateles 10,5 mm



210562A-3

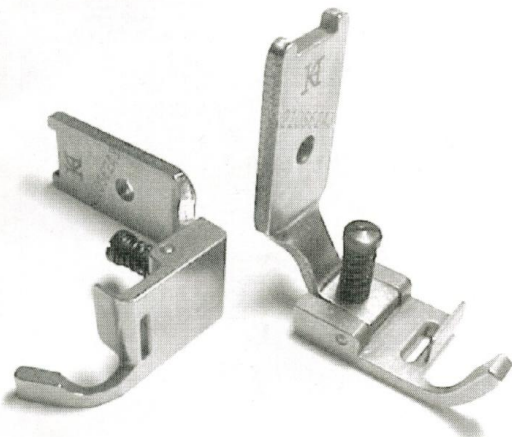

Prensateles 14,5 mm

210516A-3

210596A-3

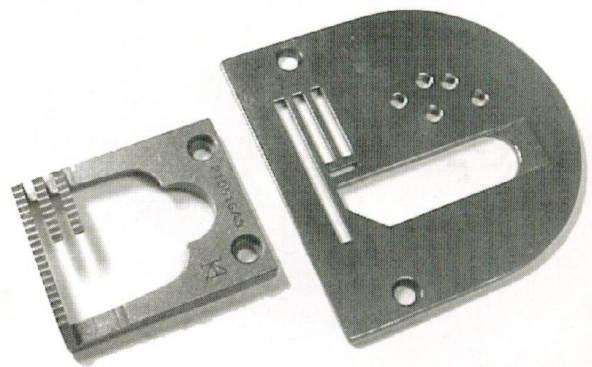

Dientes / Placa agujas:
10,5 mm

210562A-4

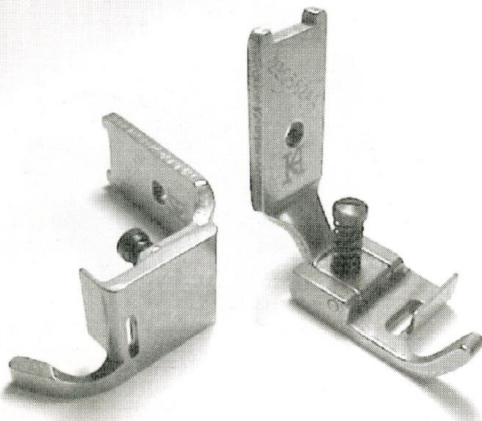

Prensateles 16 mm

210516A-4

210596A-4

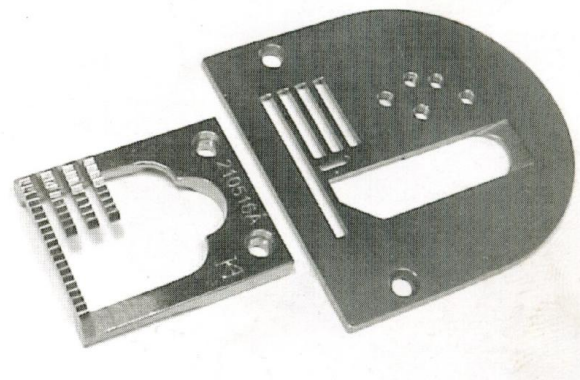

Dientes / Placa agujas:
14 mm

210562A-5

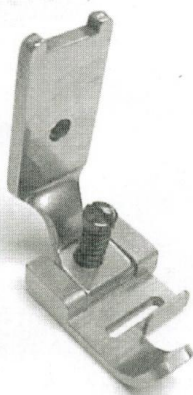

Prensateles 18 mm

210516A-5

210596A-5

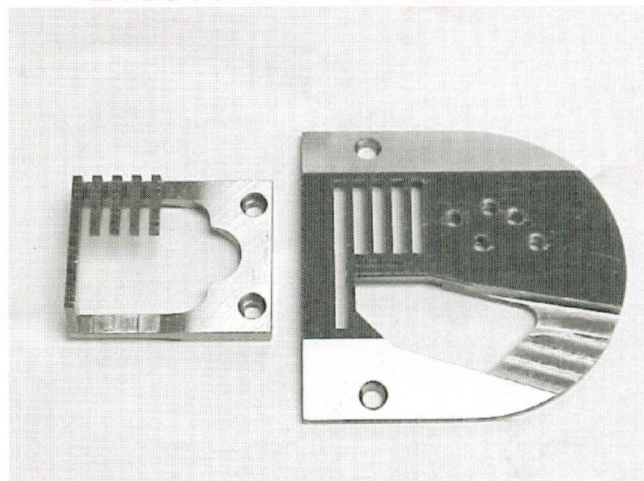

Dientes / Placa agujas:
17,5 mm



GB107



Guía

457G-188

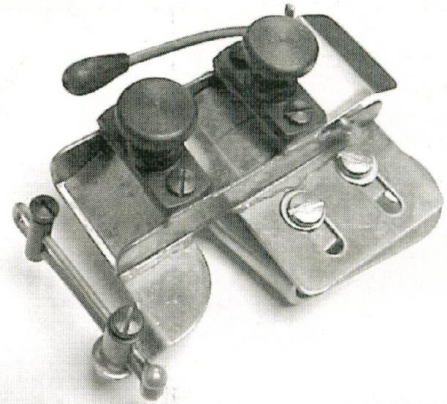

Tensor

457-T1

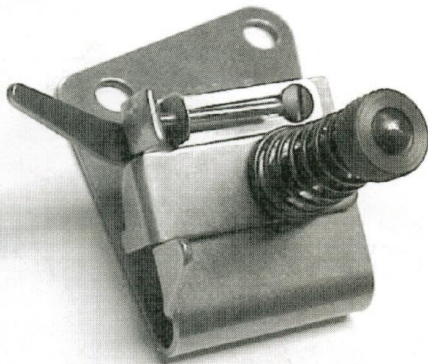

Tensor

457-T2

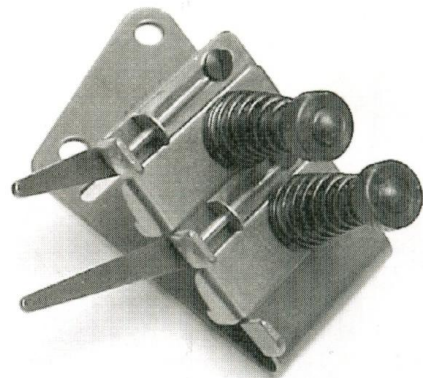

Tensor doble

KH457-T1

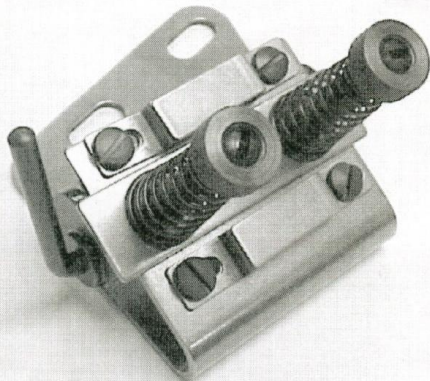

Tensor

KH457-T2

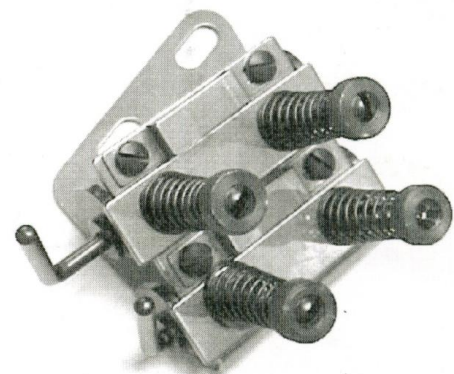

Tensor doble



Prensateles para poner tira transparente

PT-107

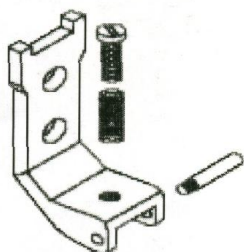

Soporte prensateles

T-086

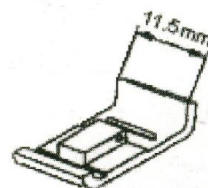

Base prensateles: 6 mm x 1,5 mm

T-254

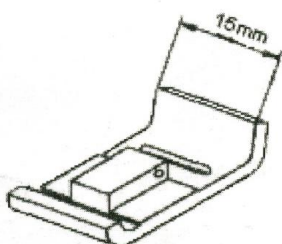

Base prensateles: 8 mm x 1,5mm

T-314

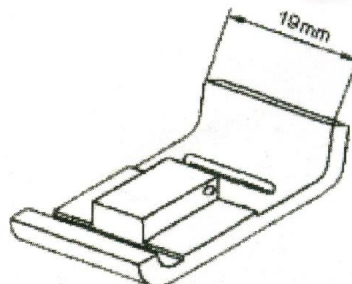

Base prensateles: 11,5 mm x 2 mm

TL-107

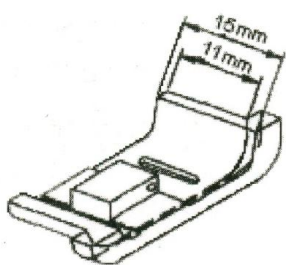

Base prensateles: 7 mm x 1,5 mm

TL-457

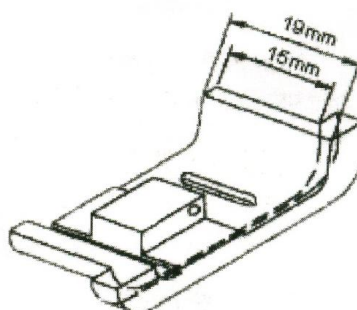

Base prensateles: 11,5 mm x 2 mm

TR-107

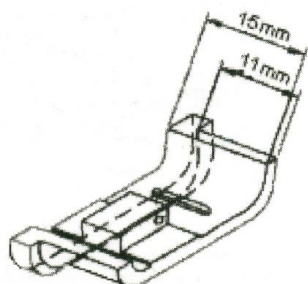

Base prensateles: 7 mm x 1,5 mm

TR-457

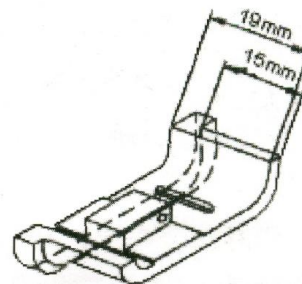

Base prensateles: 11,5 x 2 mm



ZIGZAG

Excéntricas

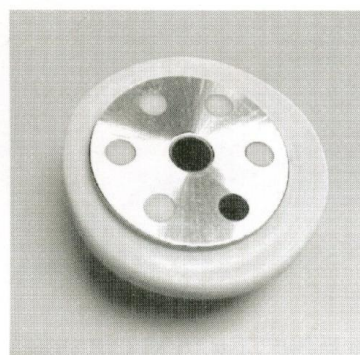

411146 (502969)



411394 (551893)

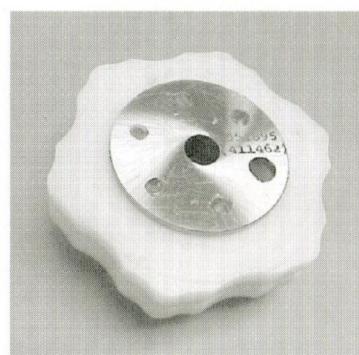

411462 (551895)

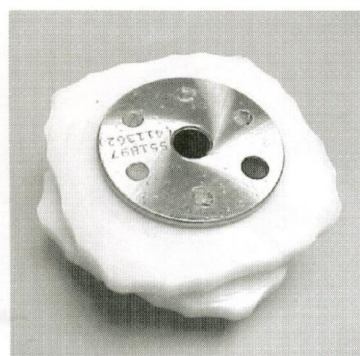

411362 (551897)

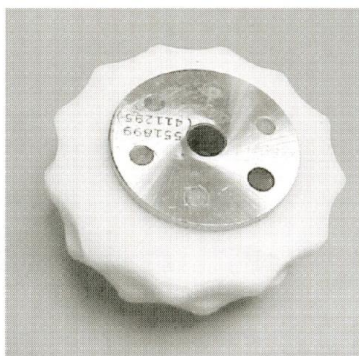

411295 (551899)

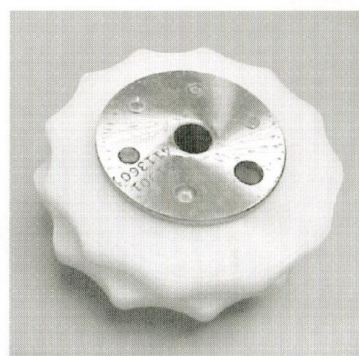

411360 (551901)

Part No.				
411146 (502969)				
411394 (551893)			5.0mm	---
411462 551895			8.0mm	---
411362 (551897)			8.0mm	---
411295 551899			8.0mm	2.6mm
411360 (551901)			8.0mm	3.6mm



Excéntricas

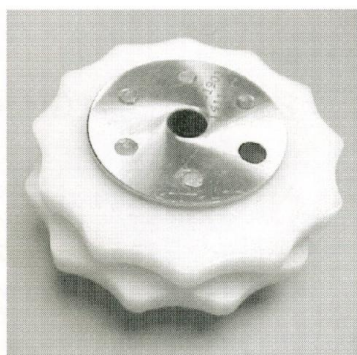

411464 (551903)

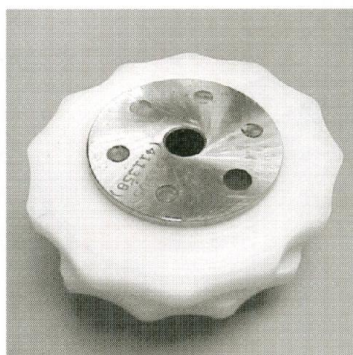

411358 (551905)

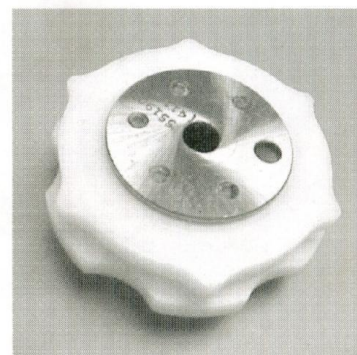

411396 (551907)



411364 (551909)

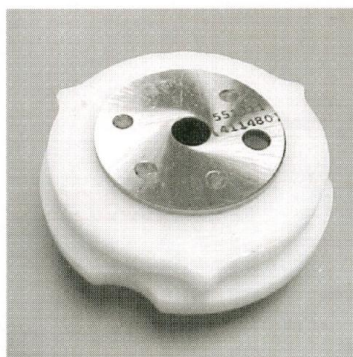

411480 (551911)

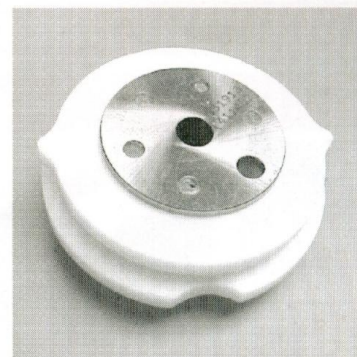

411482 (551913)

Part No.				
411464 551903			8.0mm	3.4mm
411358 (551905)			8.0mm	2.4mm
411396 551907			5.0mm	---
411364 (551909)			5.0mm	---
411480 551911			5.0mm	---
411482 551913			5.0mm	---



21010

Juego costura para poner cinta

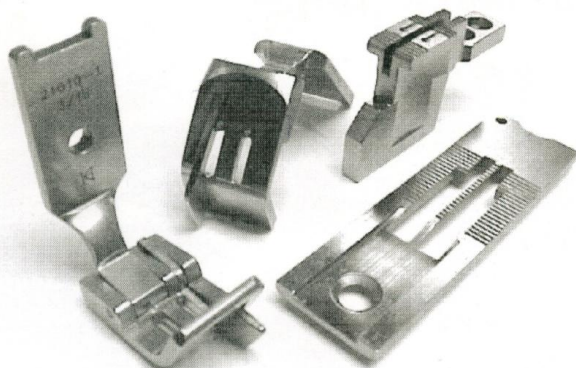

Separación agujas: 1/8", 3/16", 7/32", 1/4"

21010-1 Prensatelas

21010-2 Placa agujas

21010-3 Diente

23388

Juego costura

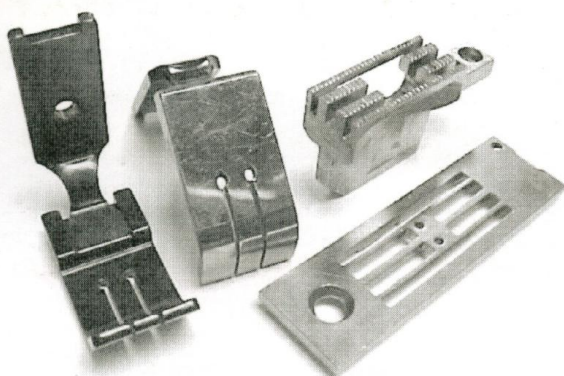

Separación agujas: 1/8", 3/16", 1/4"

23388-4 Prensatelas

23388-5 Placa agujas

23388-6 Diente

21014

Juego costura pasar aros

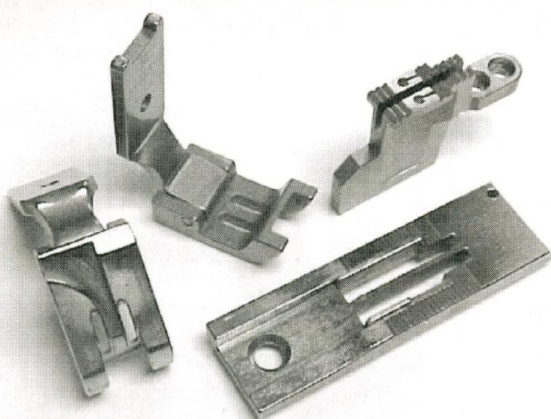

Separación agujas: 3/16", 1/4"

21014-1 Prensatelas

21014-2 Placa agujas

21014-3 Diente

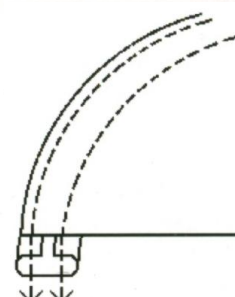

224053 Placa agujas
224029 Diente

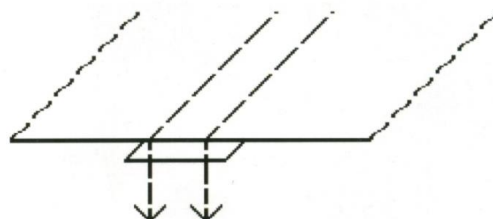
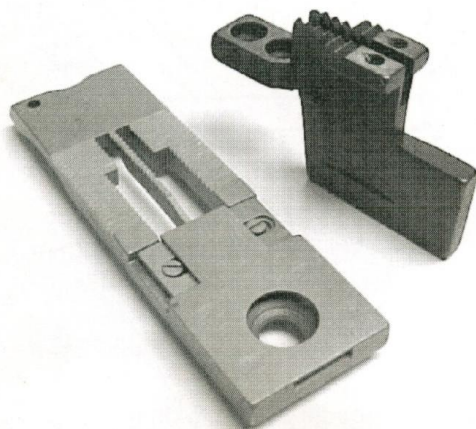

Separación agujas: 4,8 mm
 Entrada máx: 8 mm
 Separación agujas: 6,4 mm
 Entrada máx: 10 mm

Juego costura

223884H Placa agujas

223628H Diente

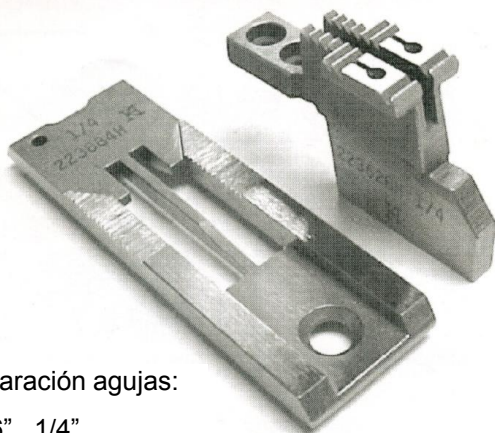

Separación agujas:
 3/16" , 1/4"

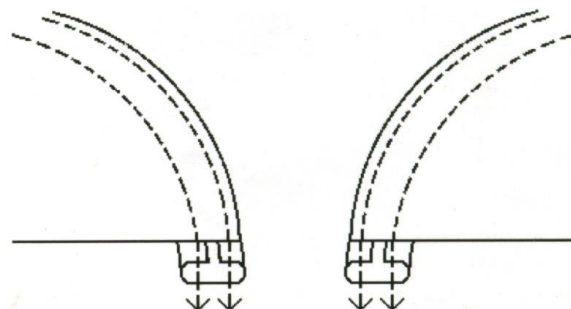

24873S

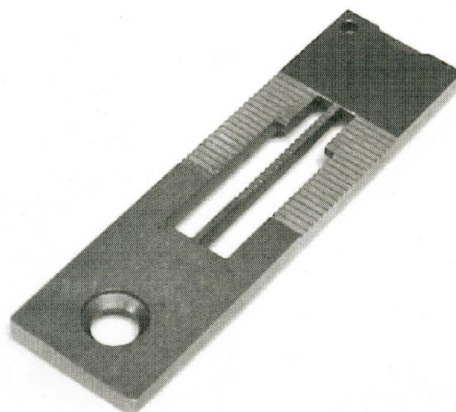

Placa agujas para género fino. 1/8"

Diente: 21010-3



212-005A





Prensateles ajustable pasar cinta.
Separación agujas: 3,2 mm, 4,8 mm, 5,6 mm

Separación agujas: 3,2 mm
Entrada: 5,5-22 mm

Separación agujas: 4,8 mm
Entrada: 6,5-22 mm

Separación agujas: 5,6 mm
Entrada: 7, 8-22 mm

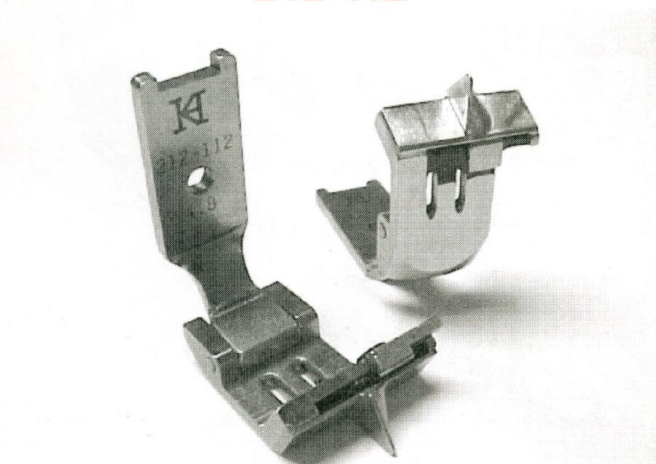
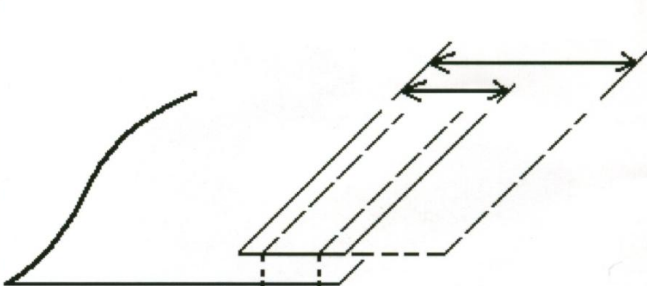
212-112

Prensateles ajustable pasar cinta.
Separación agujas: 4,8 mm, 6,4 mm

Separación agujas: 4,8 mm
Entrada: 6,5-11,2 mm

Separación agujas: 6,4 mm
Entrada: 8-11,6 mm

212-112K

Prensateles para abrir costuras

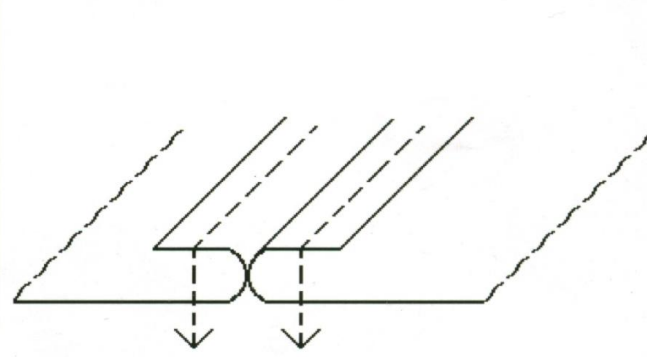
Separación agujas:
1/8", 3/16", 1/4", 3/8"



23061



Prensateles con guía

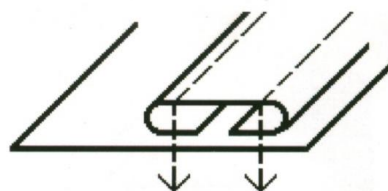

Separación agujas	ENTRADA	SALIDA
3/16"	5/8"	5/16"
3/16"	3/4"	5/16"
1/4"	3/4"	3/8"
1/4"	7/8"	3/8"

23069



Prensateles con guía ajustable para abrir costuras

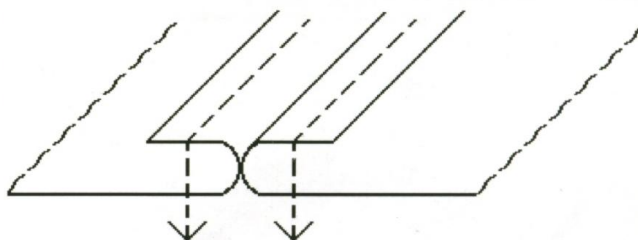

Separación agujas: 3/16", 1/4"

23071



Prensateles para abrir costuras y poner cinta

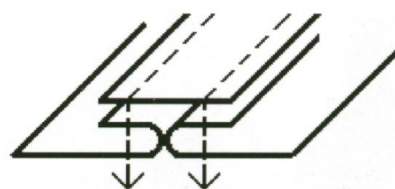

Separación agujas: 1/8", 3/16", 1/4"



23072

Prensateles con tope ajustable

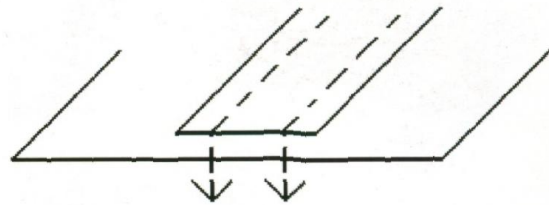
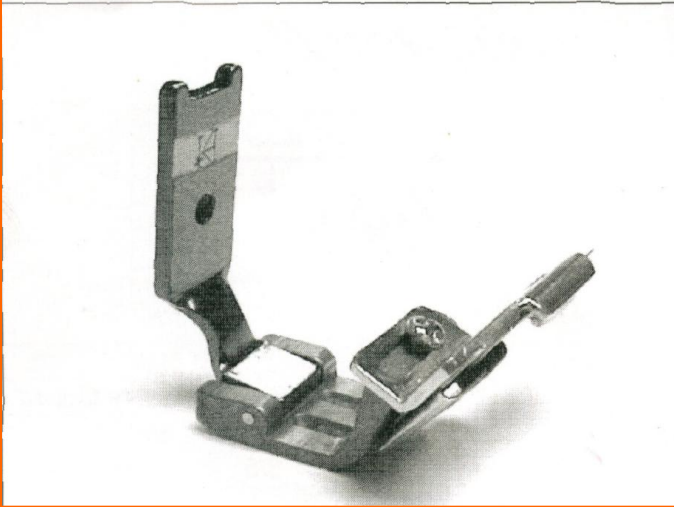

SALIDA

Ajustable. 8,5 mm-16mm

23073

Prensateles para abrir costuras con guía de boras

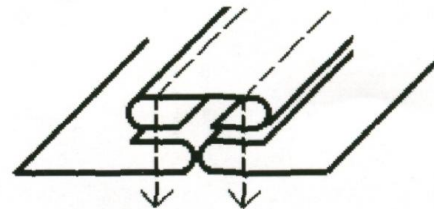
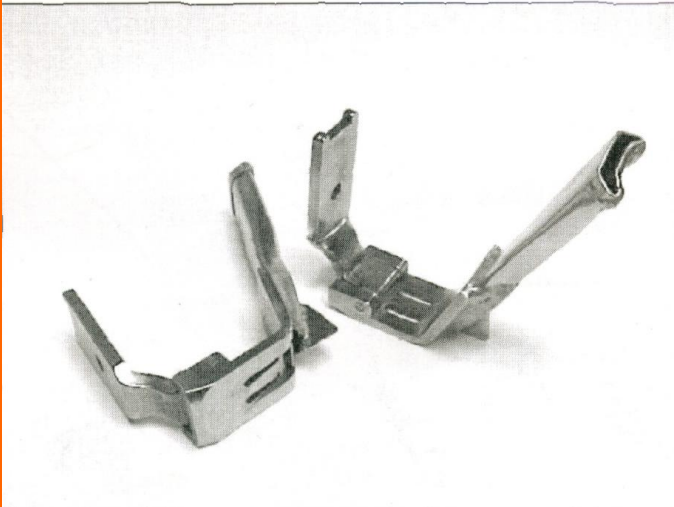

Separación agujas	ENTRADA	SALIDA
3/16"	5/8"	5/16"
1/4"	3/4"	3/8"

112W C-9



Prensateles compensado 3/16", 1/4"

223773

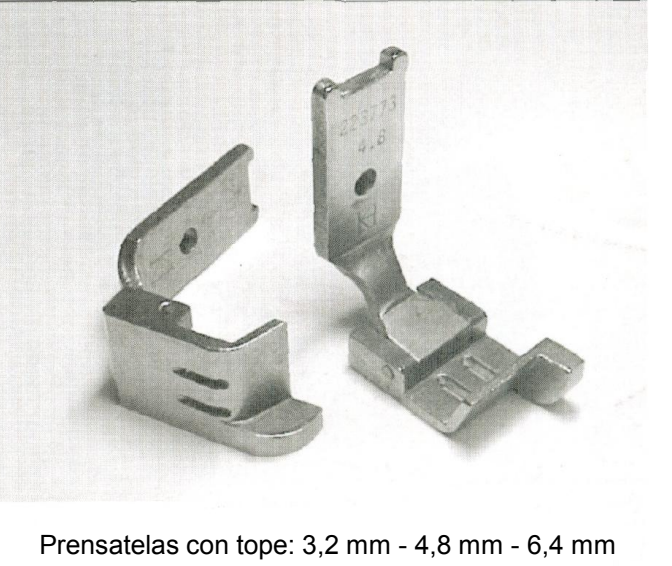

Prensateles con tope: 3,2 mm - 4,8 mm - 6,4 mm



23207

Prensateles para abrir costura y poner cinta

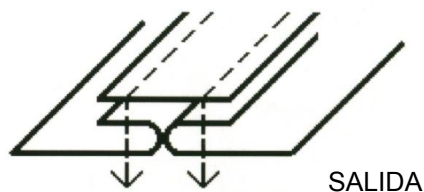
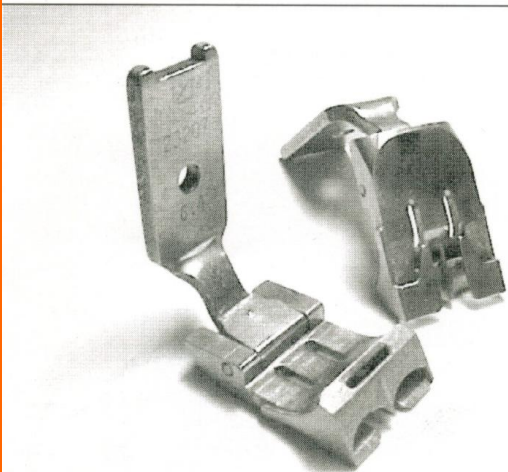

Separación agujas: 1/8", 3/16", 1/4"
Aplicable con la guía Ref. 24711

24711

Guía aérea

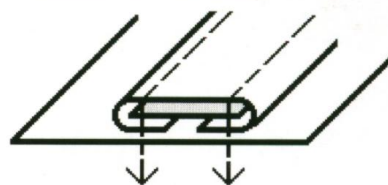
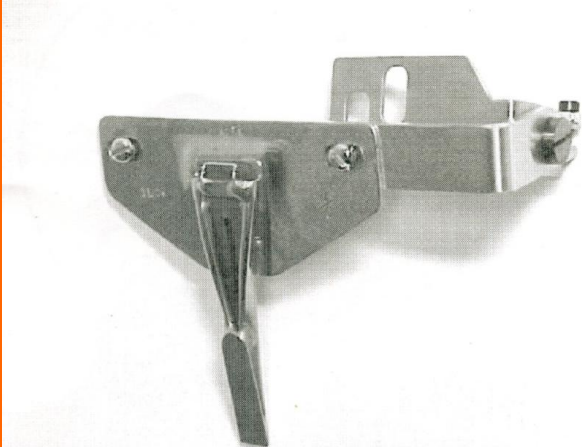

Guía Ref.24711

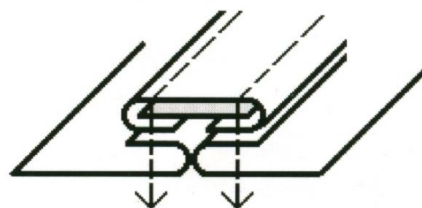

Guía Ref.24711 y prensateles 23207

21140

Guía para pasar cordón

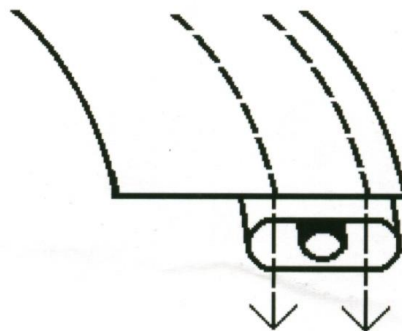
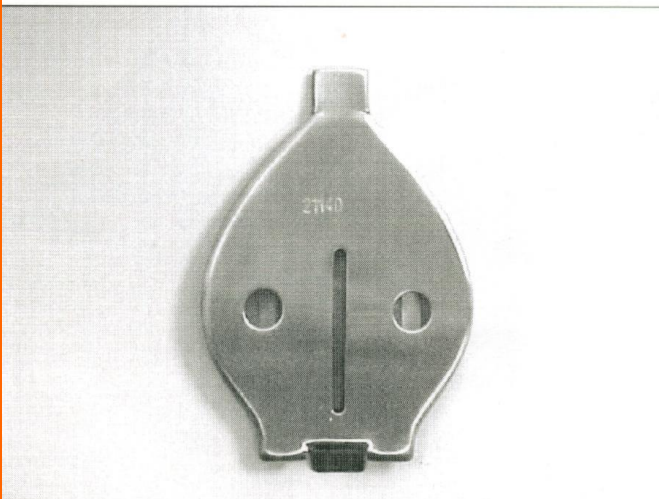

Medidas: 9mm, 10mm, 12mm



21139

21139A

Guía

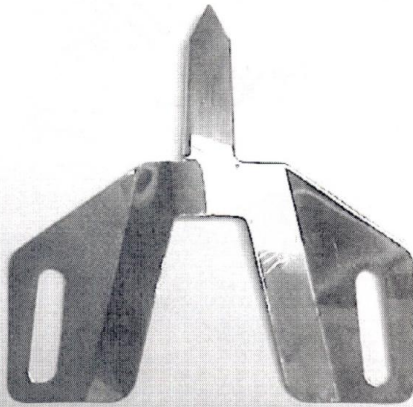

21139B

Guía

SALIDA

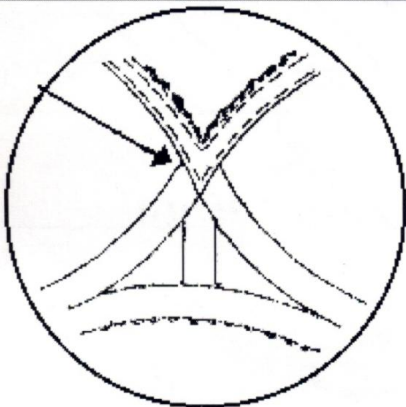
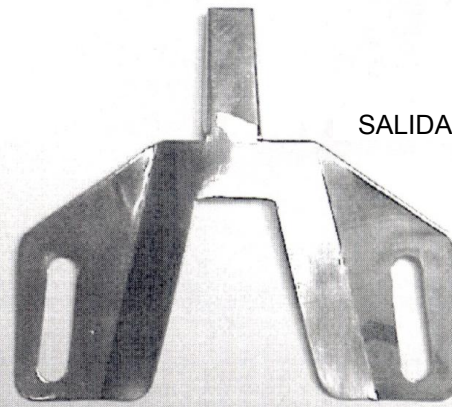

21139A

Guía



La pieza Ref. 21139A y la Ref. 21139B van aplicadas con la placa base Ref. K41B y con la guía KHF71.

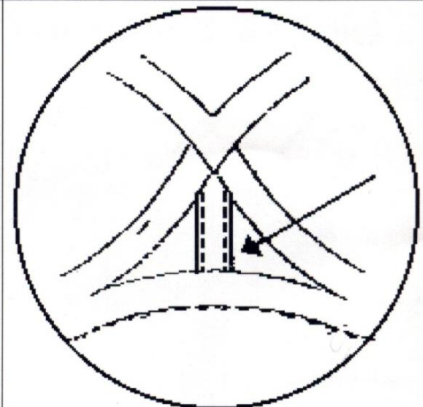

21139B
21139C

21139C

Guía

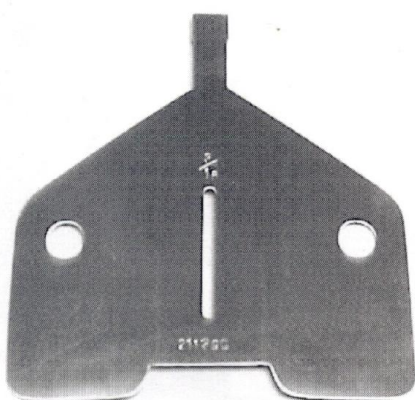

K41B

Placa Base

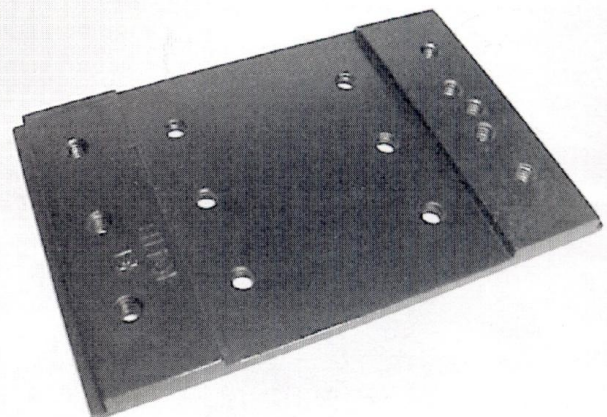

212-684

Guía aérea

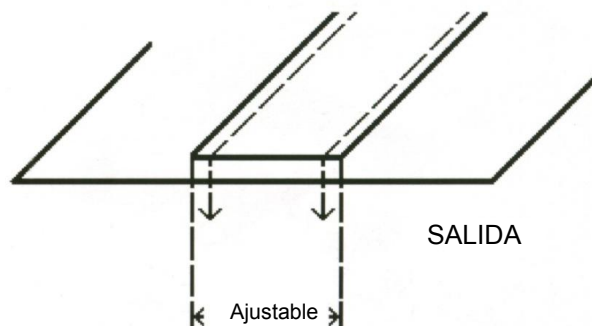
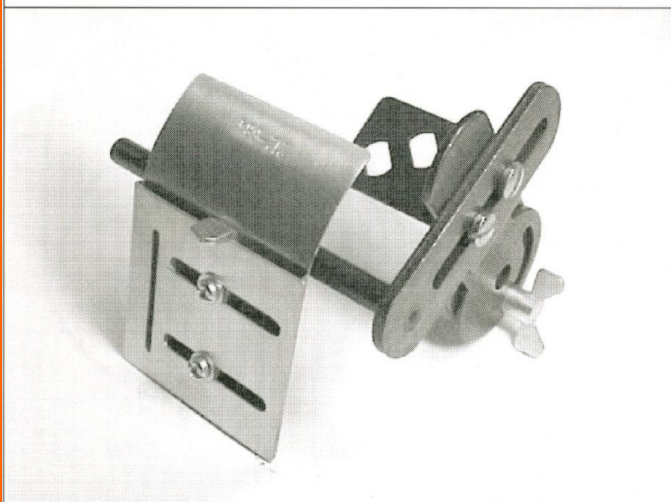

KHF38

Guía

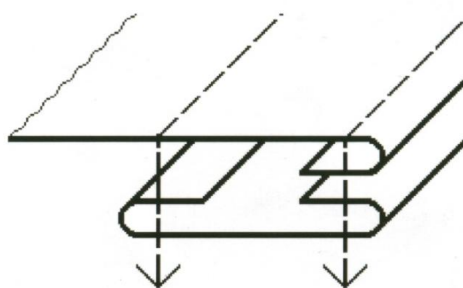

Separación agujas: 1/4"

Salida: 3/8"

KHF63

Guía

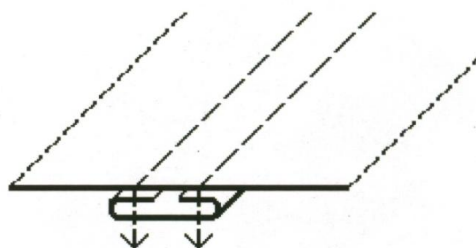
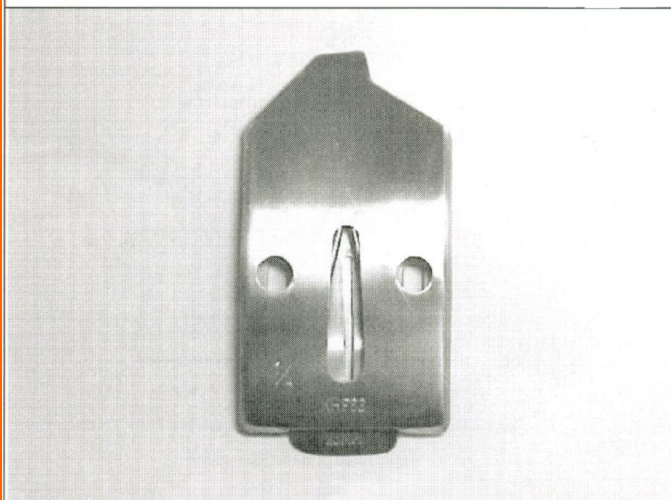

Separación agujas:

1/8", 3/16", 1/4", 5/16", 3/8", 7/16", 1/2"



KHF68

Guía para poner el forro de la copa

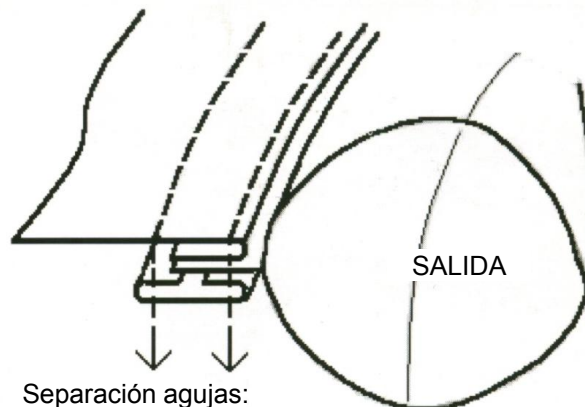
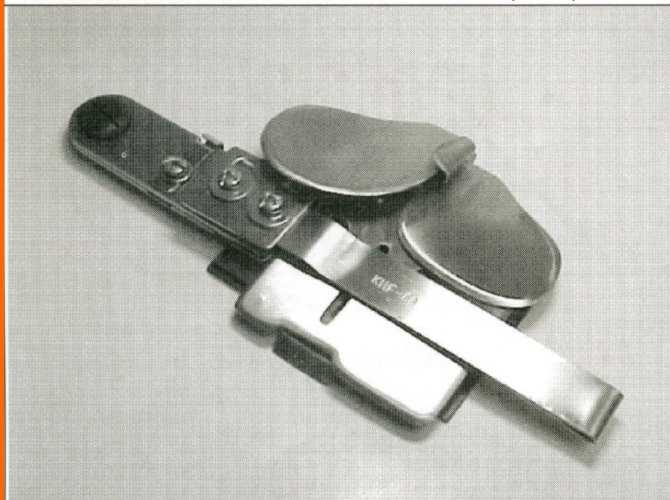

Separación agujas:
1/8", 3/16", 1/4", 5/16", 3/8"

KHF71

Guía para pasar cordón

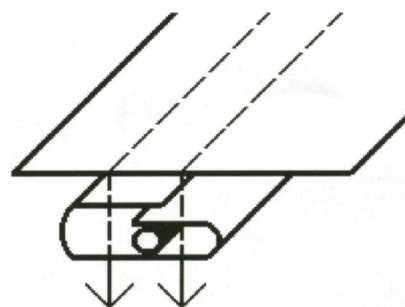
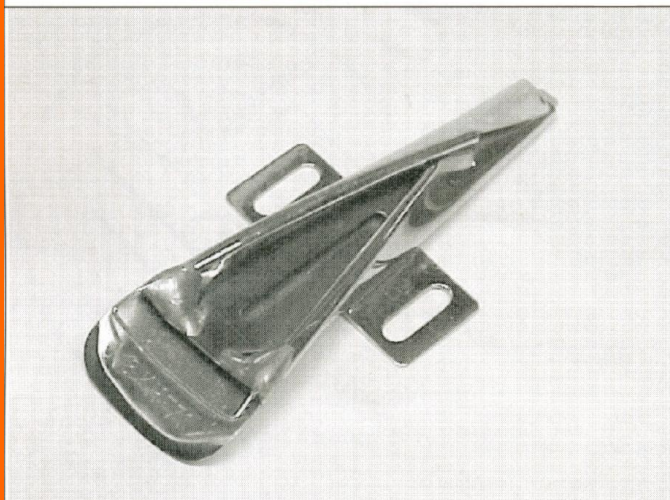

Entrada: 1-1/8" Salida: 3/8"
Entrada: 1" Salida: 3/8"

KHF77

Guía para pasar cordón con doble cinta

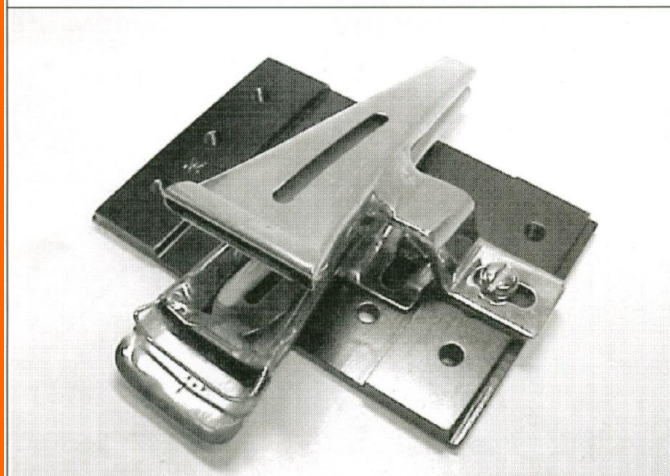

Esta guía se aplica con la placa base Ref. K41B

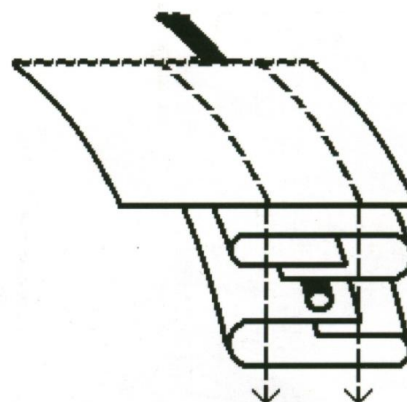

Entrada: 1" Salida: 3/8"
Separación agujas: 1/4"



KHF78

Guía para pasar cordón

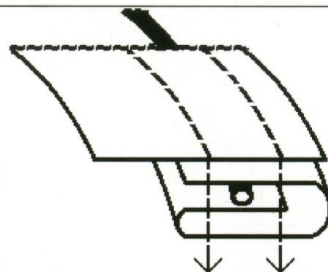
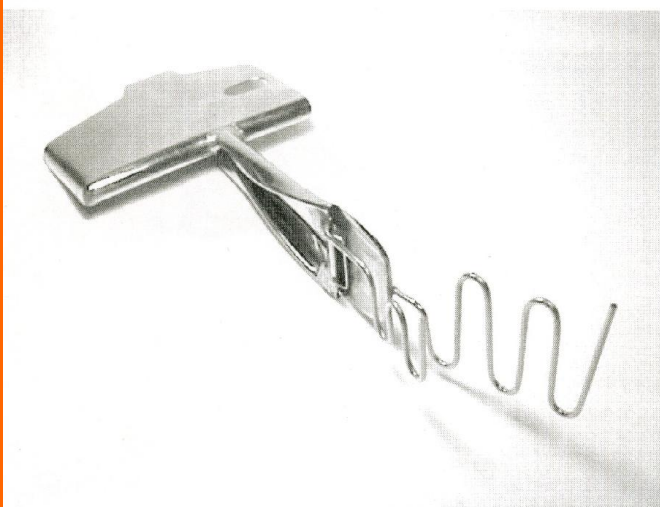

Entrada: 1-1/8"
Salida: 3/8"
Separación agujas: 1/4"

SALIDA

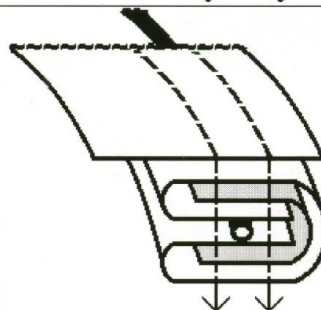

Entrada: 1-1/2"
Salida: 3/8"
Separación agujas: 1/4"

KHF81

Guía para poner puntilla

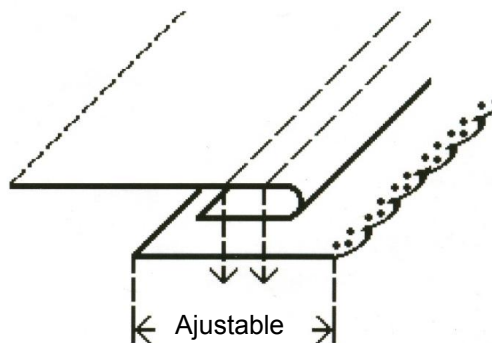
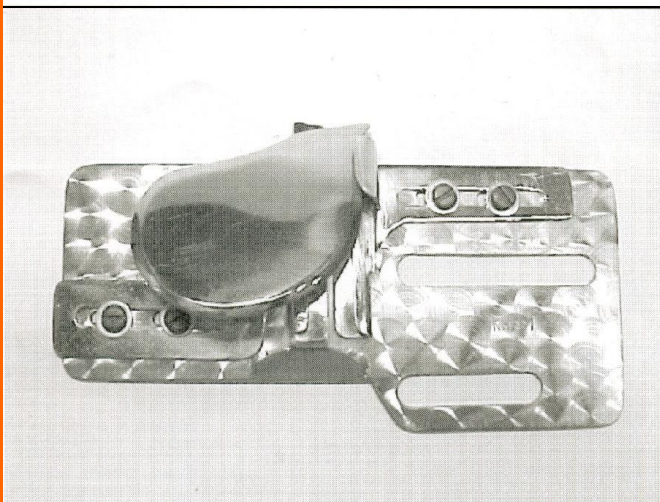

Ajustable

KHF92

Guía para pasar cordón

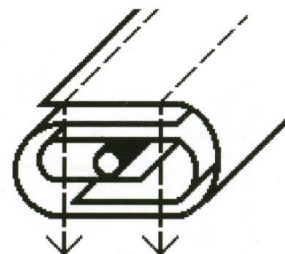
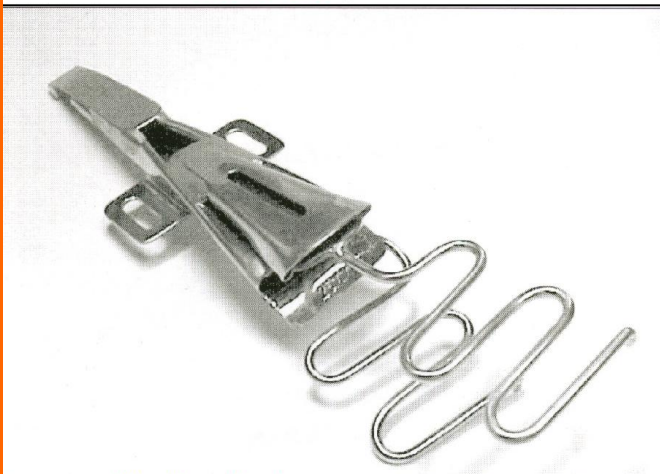

Entrada cinta exterior: 22 mm
Entrada cinta interior: 20 mm
Salida: 8 mm
Separación agujas: 1/4"



KHF96

Guía

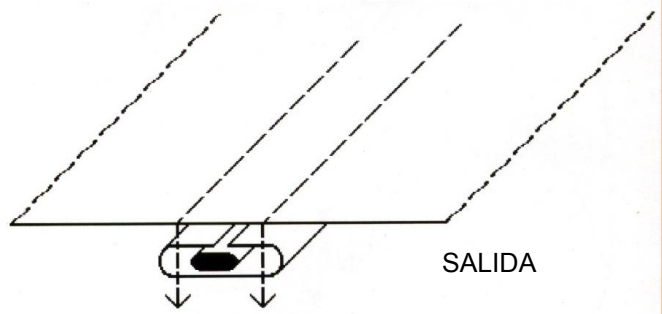
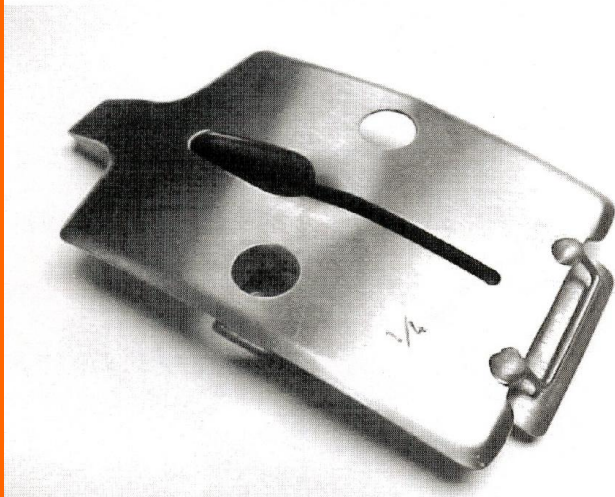

Separación agujas: 1/4"

212-96

Prensatelas con rebaje

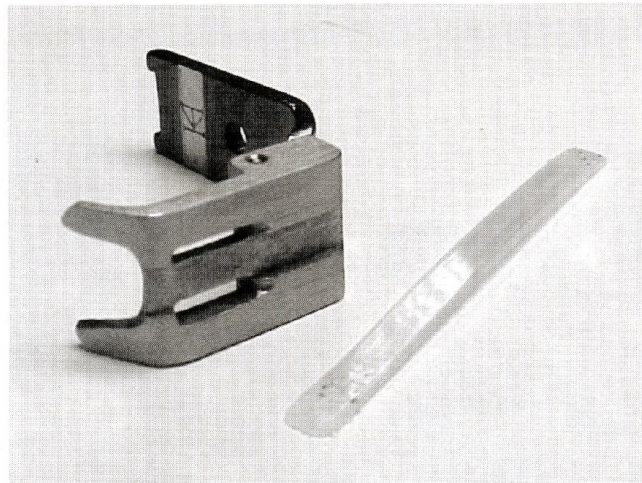

KHF97

Guía

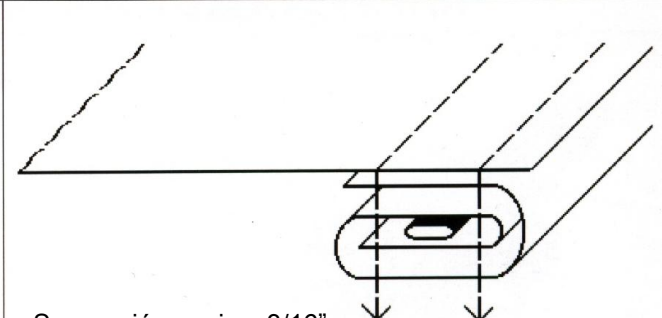
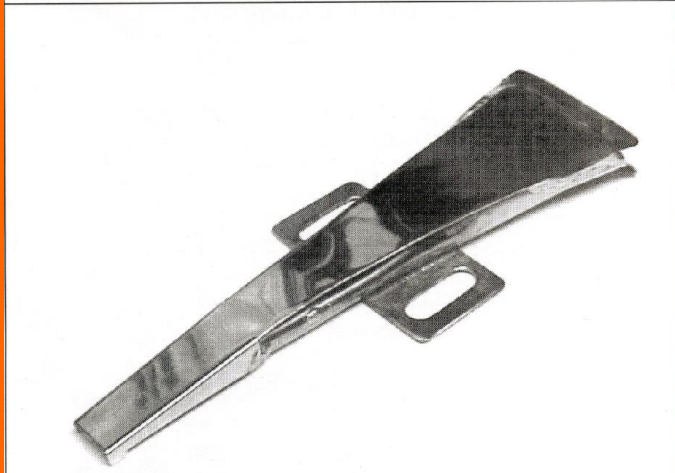

Separación agujas: 3/16"
Entrada: 30 mm
Separación agujas: 1/4"
Entrada: 40 mm



831T

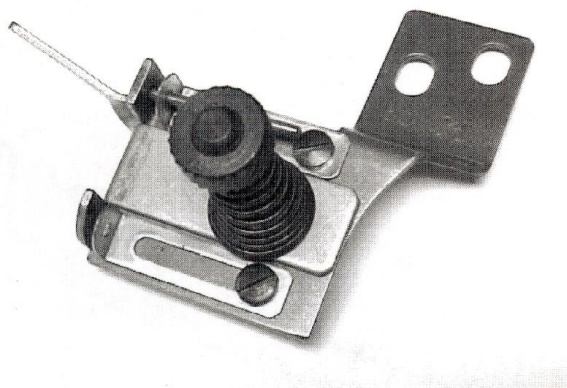

Tensor

SP-18N

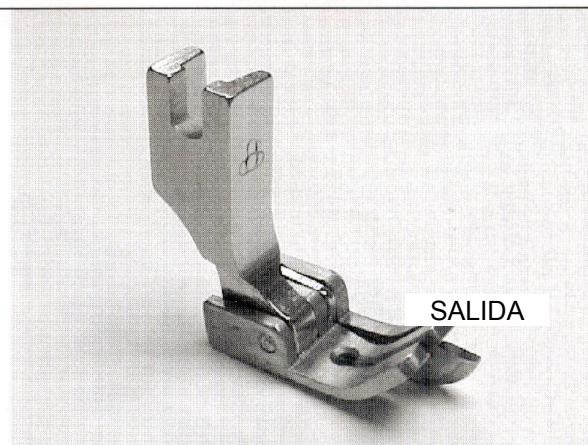

Prensateles con tope compensado a la derecha (3 mm)

K10

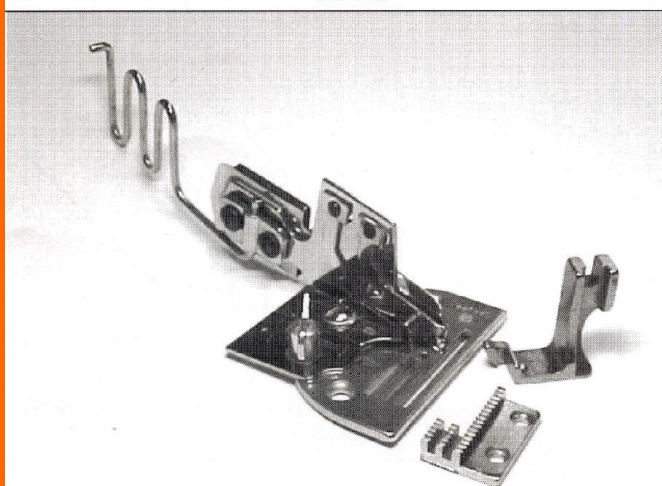

Guía

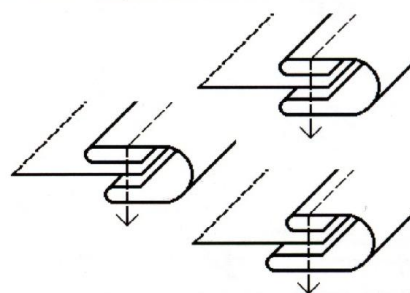

Entrada:

18 mm, 20mm, 22mm, 24mm, 26mm, 28mm, 30mm, 32mm, 34mm, 36mm, 38mm, 40mm, 42mm, 45mm, 50mm.

KHF83

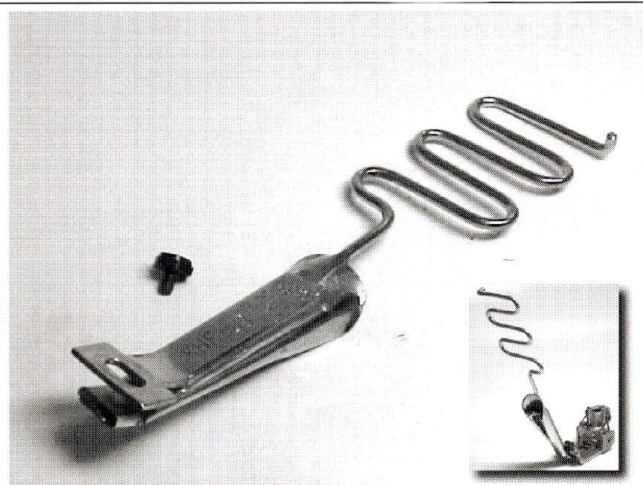

Guía

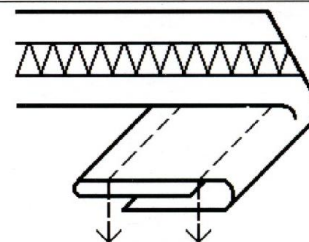

ENTRADA	SALIDA
14mm	5.6mm
15mm	6.4mm
17mm	7.2mm
19mm	8.0mm
21mm	8.8mm



KHF57

Guía de boras

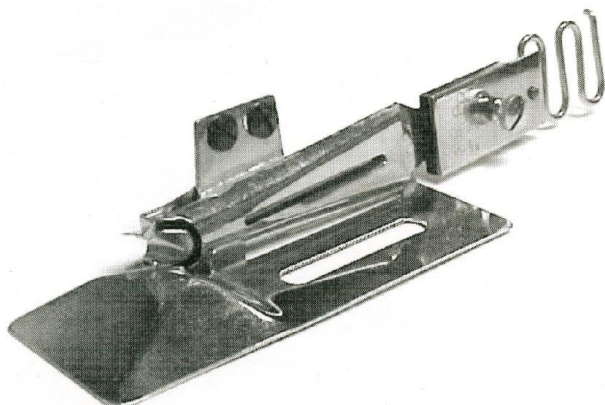

KHF62

Guía de boras

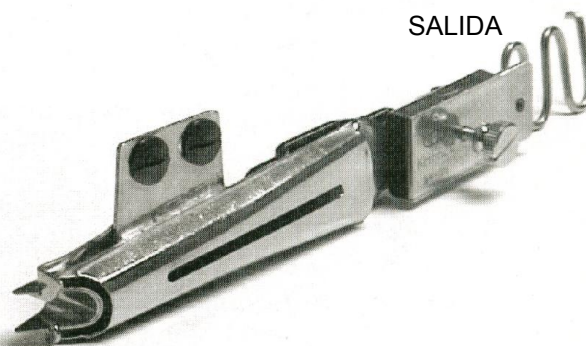

AE

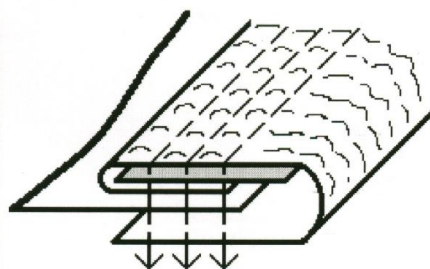

BE

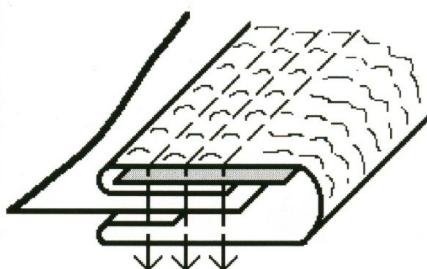

CE

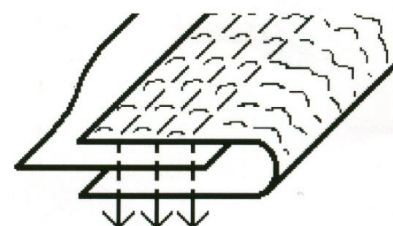

ENTRADA	SALIDA	ENTRADA	SALIDA	ENTRADA	SALIDA
3/4"	1/4"	1"	1/4"	1/2"	1/4"
15/16"	5/16"	1-1/4"	5/16"	5/8"	5/16"
1-1/8"	3/8"	1-1/2"	3/8"	3/4"	3/8"
1-3/8"	1/2"	1-3/4"	1/2"	7/8"	7/16"
1-5/8"	5/8"	2"	5/8"	1"	1/2"
1-7/8"	3/4"	2-1/4"	3/4"		
2-1/8"	7/8"	2-1/2"	7/8"		
2-3/8"	1"	2-3/4"	1"		
2-5/8"	1-1/8"	3"	1-1/8"		
2-7/8"	1-1/4"	3-1/4"	1-1/4"		
3-1/8"	1-3/8"	3-1/2"	1-3/8"		
3-3/8"	1-1/2"	3-3/4"	1-1/2"		





ADLER

**068 15 081 4
HAD-68**



MAQUINA
067;068

**069 00 581 4/ 069 15 027 4
HPF-335(5)**



MAQUINA
069;501

**098 15 007 4/ 252 781
DP2/DP2-L(N)**



MAQUINA
91;98
252;253;254;255;264

**167 00 181 4
HAD-167**



GRAN CAPACIDAD

MAQUINA
167;168
267;268

169 00 181 4



GRAN CAPACIDAD

MAQUINA
169;269

**396 15 281 4
HAD-396
HAD-196B**



MAQUINA
196;296;396

**220-181-4
HSH-445**



MAQUINA
220

**265-21-142
HSH-32**



MAQUINA
265

**467 15 009 4
HAD-467TR(Cortahilos)**



GRAN CAPACIDAD

MAQUINA
467;767

**467 15 001 4
HAD-467**



GRAN CAPACIDAD

MAQUINA
467;767

467 15 085 4/ 467 15 080 4



GRAN CAPACIDAD

MAQUINA
767



ALFA

<p>218225 DA1-B(109)</p>  <table border="1"> <tr><td>MAQUINA</td></tr> <tr><td>102;109</td></tr> </table>	MAQUINA	102;109	<p>212267G DA1-BOH(AL)</p>  <p>HILO GRUESO</p> <table border="1"> <tr><td>MAQUINA</td></tr> <tr><td>127;157</td></tr> </table>	MAQUINA	127;157	<p>212267</p>  <table border="1"> <tr><td>MAQUINA</td></tr> <tr><td>157</td></tr> </table>	MAQUINA	157	<p>127239 DA1-B</p>  <table border="1"> <tr><td>MAQUINA</td></tr> <tr><td>157</td></tr> </table>	MAQUINA	157
MAQUINA											
102;109											
MAQUINA											
127;157											
MAQUINA											
157											
MAQUINA											
157											
<p>145893 HPF-144</p>  <table border="1"> <tr><td>MAQUINA</td></tr> <tr><td>184;185</td></tr> </table>	MAQUINA	184;185	<p>145886</p>  <table border="1"> <tr><td>MAQUINA</td></tr> <tr><td>188</td></tr> </table>	MAQUINA	188	<p>214201</p>  <table border="1"> <tr><td>MAQUINA</td></tr> <tr><td>203;205</td></tr> </table>	MAQUINA	203;205			
MAQUINA											
184;185											
MAQUINA											
188											
MAQUINA											
203;205											

BARATTO

HBA-1



BARUDAN

<p>HB220010 HSM-A(MQ)</p>  <p>GRAN CAPACIDAD</p> <table border="1"> <tr><td>MAQUINA</td></tr> <tr><td>BEAM;BEAT;BEMR;BEMS</td></tr> <tr><td>BEMX;BENR;BENS;BENT;BESR</td></tr> </table>	MAQUINA	BEAM;BEAT;BEMR;BEMS	BEMX;BENR;BENS;BENT;BESR	<p>KF220880 HTH-A(MQ)TR</p>  <p>CORTAHILOS</p> <table border="1"> <tr><td>MAQUINA</td></tr> <tr><td>BEMR;BEMS;BEMX</td></tr> </table>	MAQUINA	BEMR;BEMS;BEMX	<p>KF220310 HSH-7.94A(M1Q)</p>  <table border="1"> <tr><td>MAQUINA</td></tr> <tr><td>BEAM;BEAT;BEMR;BEMS</td></tr> <tr><td>BEMX;BENR;BENS;BENT;BESR</td></tr> </table>	MAQUINA	BEAM;BEAT;BEMR;BEMS	BEMX;BENR;BENS;BENT;BESR
MAQUINA										
BEAM;BEAT;BEMR;BEMS										
BEMX;BENR;BENS;BENT;BESR										
MAQUINA										
BEMR;BEMS;BEMX										
MAQUINA										
BEAM;BEAT;BEMR;BEMS										
BEMX;BENR;BENS;BENT;BESR										



BROTHER

**153131-901
HSH-7.94BTR(R)**



CORTAHILOS

MAQUINA

BAS-23; BAS-302;DB2-B705-1,3,5
DB2-B707-3-0;-B715-1,3-0;-B716-1,3-0
DB2-B757-3-0;-B757-103,105;-B781-3-0,103
DB2-B781-104,204;-B792-3-0;-B792-400
DB2-B793-3-0;-B793-303,305,313

**159907-901
HSH-7.94B(RT)**



SINTETICOS

MAQUINA

706;714;755;757;792
793;795;758;781

**111275-001
HSH-7.94A**



GENERO GRUESO

MAQUINA

DB2-B706-5
DB2-B714-5
DB2-B755-5

**116780-901
HSH-7.94B**



GENERO MEDIO

MAQUINA

DB2-B706-3;-B714-3;-B755-3
DB2-B757-3,5;-B758;-B781,-3
DB2-B792-3;-B793-015,-017,-3;-B795-13

**143986-001/141307-901
DP2-LB**



MAQUINA

LH4-B814

**112691-901
HSH-12-15L**



MAQUINA

LT2-B831-1,-3
LT2-B832-1,-3
LT2-B833

**150371-901
HSH-12-15LC**



MAQUINA

LT2-B835-3,-5,-800

**150966-901
HSH-12-15MM(5)**



GRAN CAPACIDAD

MAQUINA

LS2-B837
LT2-B837

**153912-901
HSH-12-15MMB(5)**



GRAN CAPACIDAD

MAQUINA

LT2-B838

S07569-001



MAQUINA

845

**159155-901
DP2- 815**



MAQUINA

LH4-B815
BAS-500

**156514-901
HSH-12M(BR)**



GRAN CAPACIDAD

MAQUINA

LT2-B882



BROTHER

**S19893-901
DP2-816**



MAQUINA

LH4-B816

**150487-901
HSM-A(1)**



GRAN CAPACIDAD

MAQUINA

DB2-B745-7; BD2-B746-7; DB2-797;-5

COLUMBIA

546794



GRAN CAPACIDAD

MAQUINA

COLUMBIA 430

**272138
HSH-7.94B(451)**



SINTETICOS

MAQUINA

COLUMBIA 430



CONSEW

15040
HSH-12-15MM(5)



GRAN CAPACIDAD

MAQUINA

244, 244B, 244BL, RB, RB-1, RBL-1
254B, BH, RB-1, RB-2, RBL-2, RBH-1
255, B, BL, RB;RB-1, RBL-1

30507/15502
HSH-12-15MMB(5)



GRAN CAPACIDAD

MAQUINA

333, 333B;BL,R, RB-1, RBL-1
339RB-1, RB-2, BL, RBL-3

11124/15875
HSH-12-15L



MAQUINA

332;332 R; 332 R-1; 332 RK-1

15850
HSH-12MCA(5)



GRAN CAPACIDAD

MAQUINA

327RB-1

18033
HSM-A(5)



GRAN CAPACIDAD

MAQUINA

206RB;306RB

2110314-310
HSH-7.94C



SINTETICOS

MAQUINA

210;230;310

1166/2113004-310
HSH-7.94B



MAQUINA

210;218;219;230;231R
290;291R;310;318R

10655
HSH-11-55



MAQUINA

139;139 R-1; 224; 224 R-1; 225; 225 VM;225 VMG
226; 226 R-2;237; 245; 266 R-1;226RVM-2

HLE-170



MAQUINA

180; 180J; 181; 182

213 0104-300B
HSM-B(Z17)



GRAN CAPACIDAD / ZIG-ZAG

MAQUINA

175RB

143986-001/ 141307-901
DP2-LB



MAQUINA

7130/4

211704-340
HSH-7.94BTR



CORTAHILOS

MAQUINA

290 RATCW; 291 RATCW; 312 RATC
318-1 RATC, RH



JUKI

**B-1830-127-OAO
HSH-7.94B**



MAQUINA
DB2-B706-3;-B714-3; -B755-3
-B757-3, -5 ; -B758; -B781, -3, -B792-3
-B793-15 -17 -3 -B795-13

**B-1830-055-OAO
HSH-11-55**



MAQUINA
LU-53; LU-55, -2, -3; LU562, -3

**B-1830-512-OAO
HSH-21-40(J)**



MAQUINA
LH512, -3; 515

**B-1830-051-OAO
HSH-12-15**



MAQUINA
LH-51, -10; LH516; LH517
LH-518; LU-53-7; LU562-A

**B-1830-563-OAO
HSH-12-15MMJ**



GRAN CAPACIDAD

MAQUINA
LH-513; LU-563

**B-1830-057-SAO
HSH-445(SP)**



MAQUINA
LG-57, -1; LG-158, -1

**B-1808-761-OAO
DP2-NJ**



MAQUINA
LBH-761; LBH-762; LBH-763

**B-1808-771-OAC
DP2-NJ771(2)**



MAQUINA
LBH-771, 2,3,4; LBH-781,2,3,4

**B-1830-521-HAO
HSH-12MCA(2)**



GRAN CAPACIDAD

MAQUINA
LUH-521; LUH-527

**100-32555
DP2-57(3LP)**



MAQUINA
LZ-1280; LZ-1285, 6, 7

**137-29058
DP2-NJ(790)**



MAQUINA
LBH-790; LBH-791K

**B-1830-555-BAO
HSH-7.94BTR**



CORTAHILOS

MAQUINA
DDL-500, A; -501,A; -505,-100,-200, -300
505A-100, -200, -300; -506; 552-2/-1T/4; -553-4
-552-2, 2B-2, 2B-555-4; -5570M; DLD-432-2,-3,-4,-5
DLN-412-2;-415-2,-4;DLU-3,-4;-591;DMN-530-5,-531-5



JUKI

101-10062
HSH-12(2)TR



CORTAHILOS

ANIQM
021HL

102-07959
HSH-12-62C(L)



IZQUIERDA

ANIQM
281HL

102-08056
HSH-12-62C(R)



DERECHA

ANIQM
281HL

101-31058
HSH-12M-82CTR(L)



IZQUIERDA
CORTAHILOS

ANIQM
542HL

102-31157
HSH-12M-82CTR(R)



DERECHA
CORTAHILOS

ANIQM
542HL

100-78954



ANIQM
02HL

225-25059
DP2-57(3LP2R)



ANIQM
02 02



MITSUBISHI

**P975007X10/MF16A0120
HSH-7.94B**



MAQUINA

DB120-1, -2; -126-10; -130-10, -11; 130G-10
DB-130GM-10; -132G-10; -170-10, -11; -171;
LS2-130-M; -MOB; -150MOB
DB-680-MOB; -1130-M; -1130-MOB

**A190D11DP01/MN10A0120
HSH-12-15M**



MAQUINA

DB-286, -10; DN-260, -7, -10; -265, -10
LT2-220-M, -MOB; -2220-L, -LOB, -M, -MOB

**A190D111P01/MN12B0120
HSH-12-15MM**



GRAN CAPACIDAD

MAQUINA

DN-260-22; -262; -265-22; 267; LT-220-BOB
LT2-2220-B, -BOB

**P975033X01/MF25B0120
HSM-A**



GRAN CAPACIDAD

MAQUINA

CU-865-22FP; DB-130-22, -130E-22; -132G-22
'-325-22; -327; DX-370-20; -377; DY-330-22
DY-337; -340-22; LS2-130- BOB

**MT70A0120
DP2-57(2)**



MAQUINA

LZ-720, -11; -780, -11; -790

**A190D177P01/MG44B0120
HSM-A1HTR**



**GRAN CAPACIDAD
CORTAHILOS**

MAQUINA

DY-339; -340-22BZ; -349-22BZ; DB-189-22BZ

**A190D091P01/MN62E0120
HSH-12MC(3)**



GRAN CAPACIDAD

MAQUINA

LT2-250-A/B, -A1T, -B1T; LT2-2250A, B,
A1T, B1T; PLY-1185; -7181; -7182; -7204; -7206,



NECCHI

221525-4-00
HNE-835/ HNE-830



MAQUINA
802; 812; 830; 832; 835; 881; 885; 883-100, -101 -260; 891-100, -260, -261, -570, -571; 895-100 -101, -103, -104, -110; 895-256, -260, -261, -263 -264, -265, -570, 571; SG; SM; UAN-1531

971312-6-02



MAQUINA
902-155; 931-100; -101; 932-100

114524-6-02



MAQUINA
910-113, -159, 911-113; 930-113; -159

8250
HPF-3114



MAQUINA
403; 408; 411; 412; 413; 414 416; VAN1405, 1416

227525-4-00



GRAN CAPACIDAD

MAQUINA
891-104, -264; 895-108, -111; 895-266 895-267, -268, -566, -567, -568

971903-4(10)



MODELO ANTIGUO

MAQUINA
400

554575-4-00
DA1-BOH(AL)



MAQUINA
860

121525-4-00
HNE-835/ HNE-830



MAQUINA
802; 812; 830; 832; 835; 881; 885; 883-100, -101 -260; 891-100, -260, -261, -570, -571; 895-100 -101, -103, -104, -110; 895-256, -260, -261, -263 -264, -265, -570, 571; SG; SM; UAN-1531

971903-4



MAQUINA
400.401, 402; UAN1401; UAN1601; UAN1602

971842-4



MAQUINA
527; 529; 533; 720; 721; 840



PFAFF

**8250
HPF-3114**



MAQUINA
110, 111, 112, 113, 114, 115, 116; 3114

**120710
HPF-3116**



MAQUINA
3116

**10165
HPF-151**



MAQUINA
120; 122; 141 A, B; 142 A, B; 142-721/01
145-H3B; 146-H3; 191; 192 A, B; 192-721/01
193 A, B; 194 B; 195-H3B; 196-H3B, 292 B, BN
9491;9493

**10896
HPF-114**



MAQUINA
120; 122; 141 A, B; 142 A, B, C; 143-944/01
144-720/02; 144-944/01 A, B; 145-H3B, 146-H3
191; 192 A, B, C; 193 A, B; 194 BC
194-720/02-944/01; 194-944/01 A, B; 195-H3B
-H3C, -H3D; 196-H3B, H3C; 292B, BN, C; 293
294; 892 A, B, L; 893 A, B, L; 9491; 9493

**10850
HPF-145**



MAQUINA
142C, D; 143-705/03C; 192C; 194C
194-944/01C; 195-H3C, -H3D; 292C

**119386
HPF-490**



MAQUINA
471 A, B; 472; 474 A, B; 491 A, B

**18340
HPF-545**



GRAN CAPACIDAD

MAQUINA
541 C, D; 542 C; 543 C; 544-720/02 (2,4-7,2)
544-944/01 C, C/D; 545-H3C, D; 546-H3C, D
593-944/01 C; 594-720/02-944/01; 594-944/01
595-H3S; 596-H3; 1244 D; 1245-706/47; 1291 C;
1293; 1294; 1295 C, D; 1296 C, D

**168885/167600
HPF-438**



MAQUINA
437; 437-900/...; 438; 438-716/... (-900/...); 438-900
439; 439-900/...838; 838-900; 937; 937-900/...; 938
938-716/...(-900/...); 938-900; 939; 939-900; 3844-1/01

**105490
HPF-335**



MAQUINA
134-O-92; 138; 230; 260; 331

**63090
HPF-234**



MAQUINA
234

**171820/ 171910
HPF-480**



MAQUINA
432; 461-469; 480-489; 560; 561

**91-168888-91
HPF-418**



GRAN CAPACIDAD
MAQUINA
417, -900; 418, -900; 419, -900



PFAFF

**91-629677-91
HPF-3518**



GRAN CAPACIDAD

MAQUINA
3518

**14192
HPF-345**



MAQUINA
341-6 A, B; 345-H3; 345-6S; 353; 354

**118876
HPF-442**



MAQUINA
441-0; 442; 442-720/04; 442-0-R; 444 A, B 444-0, -R; 448-0; 457-0

**118419
HPF-442TR**



CORTAHILOS

MAQUINA
441-0-900/...; 442-0-900/ ...; 442-R-900/11; /51 444-900/ A, B, ; 444-0-900/...; 444-R-900/...
448-0-900/...; 457-R-900/...

**140538
HPF-1242**



GRAN CAPACIDAD

MAQUINA
1241 B, B/C; 1242-732/09 B; 1242-748/01 B 1245 B; 1246 B; 1246-720/...(3,2-7,6); 1441 B 1442 B; 1442-720/04 B; 1445 B; 1446 B

**140539
HPF-1242(A)**



GRAN CAPACIDAD

MAQUINA
1241 C, D; 1242; 1242-748/01 B, C; 1243 1244 C; 1245 C; 1246 C, D; 1441 C; 1442 C 1442-720/04 B/C, C; 1445 C; 1446 C

**140540
HPF-1242TR**



**GRAN CAPACIDAD
CORTAHILOS**

MAQUINA
1241-900/...B, B/C; 1242-732/09-900/B 1245-900/...B; 1246-900/...B; B/C; 3802; 3826-2/01

**140451
HPF-1242(A)TR**



**GRAN CAPACIDAD
CORTAHILOS**

MAQUINA
1242-900/...; 1243-900/...; 1244-900/...C 1245-900/...C; 1246-900/...C



SINGER

**410019/541674
DB1-BZ(20)**



MAQUINA
20U

**244088
HSH-8-20**



MAQUINA
61W; 108K

**142019/ 52089
DA2-A(TA1-A)**



MAQUINA
95-10; 96-16; 103K

**144830FG/127119FG
DA1-B**



MAQUINA
95-40; 9-40

**224460/ 210533
DP2/DP2-L(N)**



MAQUINA
107G; 107W1; 517

**240207
HSH-11-53**



MAQUINA
111W 100-103; 113; 154; 154

**240240
HSH-11-51**



MAQUINA
111W 150, 151

**240558
HSH-11-55**



MAQUINA
111W 155, 156; 211G 155, 156; 211U 165, 166
341; 365; 211UX 165, 166; 211W 151, 155

**224016/ 237204
HSH-12-15**



MAQUINA
112W 115-139

**248463/248445
HSH-12-40**



MAQUINA
112W 140, 145, 146

513170/ 522540



DOBLE ARRASTRE

MAQUINA
770; 771G

**522454
HSM-A/ HSM-B**



GRAN CAPACIDAD

MAQUINA
121C 300; 121 D300; 121C 330; 121D 330



SINGER

**103123
HSH-32**



AN I LQAM
541 1441

**265361
HSH-445**



AN I LQAM
541 1441

**514236
HPF-545(S)**



GRAN CAPACIDAD

MAQUINA
211G351, 357, 358, 465, 466, 765, 766; 211GX102 212GX108; 212G641; 212GXB, 102, 104, 108, 110

**267357/244711
HSH-21-40**



MAQUINA
211G 146, 151, 157, 157A, 158, 166, 265, 266 211GX 110, 115; 211U 157, -257; 211UX 157 212G 140, 141, 145, 440; 212GX4-6; 212LX 670 212 U 41, 442; 212W 140, 145, 146

**512555/34804
HSH-21-40TR**



CORTAHILOS

MAQUINA
211G451, 457; 212G440, 441; 212U441

**510008
HSH-12-15MM(S)**



GRAN CAPACIDAD

MAQUINA
211G 557, -558, -566, -566A-866, -866A, -867A 211GX104, 106, 109, 114, 117; 211U566; 211U866 212G539, 541; 212GX-106, 114; 212U 541A, 841A

**34803
HSH-21-40TR(S)**



CORTAHILOS

MAQUINA
211GX101, 103, 112, 211, G665, 666, 212 G440, 441, 212GX45, 101, 103, 107

**412433
HSH-21-40(S)C**



MAQUINA
212 U 143A, 144, 443, 444

**106268/ 271575
DP2-71**



MAQUINA
271K

**143342FG
HSH-7.94B**



MAQUINA
241;251;366

**149172
HSH-7.94B(AC)**



**REFRIGERADO POR AIRE
ALTA VELOCIDAD**

MAQUINA
281

**502718
DP2-57(2)**



MAQUINA
457



SINGER

**508508
DP2-57(2)COB**



**PUNTA EXTRADURA
TUNGSTENO**

MAQUINA

457G

**509083/ 34802
DP2-57(2LP)COB**



PUNTA LARGA

MAQUINA

457; DZ S310

**540733
HSH-7.94BTR(491)**



CORTAHILOS

MAQUINA

491D; 591D

**544784
HSH-7.94BTR(591D)**



CORTAHILOS

MAQUINA

591D 200, 210BD, GD, BF, GF, 0 215BD, GF; 240BD
GD; BF; GF; 300BD; GD; BF; GF; 310BD; GD; BF; 315BD
GD; BF; GF; 318BD; D; BF; GF; 591DX 200GX; 210G, GA, 300G, GA
310GA, GAC; 591E 210G; 591F 200B, G; 591U 313GAE, 320GF;
591UX 100BF; GF; 200 GF; 312 BF; GF; BF; GF; 320GF; 591 V 200B
300B; 601D 100AD; AF; BD; BF; GD; GF

**282293
DP2-457U(T)**



CORTAHILOS TITANIO

MAQUINA

457A

**239780/ 530199
HSM-B(Q)TR**



**GRAN CAPACIDAD
CORTAHILOS**

MAQUINA

121C 300, -330; 121D 300, -330; 369W

**414430
HSH-7.94BTR(591DT)**



CORTAHILOS TITANIO

MAQUINA

491D; 591D

HTH-A(MQ)TR



MAQUINA

191D



REFREY

**90-112-40
HPF-144**



MAQUINA
901; 902

**127239
DA1-B**



MAQUINA
906; 910; 918

**91-12-00
HDU-211**



MAQUINA
920; 921; 925

92-12-00



CORTAHILOS

MAQUINA
920/3; 921/3; 925/3; 927/3

901 240



MAQUINA
906

B-814-1



MAQUINA
427-430

**1920 1200
HSM-B(OP)**



GRAN CAPACIDAD

MAQUINA
1920; 1922; 1923; 1925; 1927

931240



MAQUINA
930

1901 1200



GRAN CAPACIDAD

MAQUINA
1901; 1902

1901 1200/41



CORTAHILOS

MAQUINA
1901/41; 1902/41

B-814-1-930N



MAQUINA
930

**9051240
HSM-A**



GRAN CAPACIDAD

MAQUINA
905



U. SPECIAL

61407B/61207D
HUN-614C



MAQUINA

61200, 300, 400, 900; 63400, 900

29474H/29474AC
HUN-622



MAQUINA

61800; 62200

61407BFG
HUN-614B



MAQUINA

61200, 300, 400, 900; 63400, 900



ALFA

2515



MAQUINA
20

125292



MAQUINA
40

ADLER

20-195
HSH-7-3



MAQUINA
20; 21

048-00125-2
TF1



MAQUINA
48

005002904



MAQUINA
104; 105

204150104
HAD-204



MAQUINA
204; 205; 504

BROTHER

152685-001



MAQUINA
430

152687-001
TEJIDOS GRUESOS



MAQUINA
430H

CONSEW

40028



MAQUINA
7140

DÜRKOPP

570 1242



MAQUINA
560; 570



JUKI

B1818-280-000
HLK-280



MAQUINA
LK280; 980; 1850

B1818-282-N00



GENEROS GRUESOS

MAQUINA
LK282; 980; 1850

B1823-232-000



MAQUINA
LK232-322

NECCHI

11540
DD1-NECCHI



MAQUINA
630~633; 640~644

PFAFF

6560



TEJIDOS FINOS

MAQUINA
34 A, B; 3125, 35, 36; 3331, 34, 35

6694



TEJIDOS GRUESOS

MAQUINA
34 C; 3125, 35, 36; 3331, 34, 35

1371117



MAQUINA

3336 A, B; 3337 A, B; 3370 A,

MITSUBISHI

MS01A0120



MAQUINA
PLK-109

MS17A1120



MAQUINA
PLK-1006

SEIKO

8028
TF1



MAQUINA
TE-2,5,6; TF-5,6

35224



MAQUINA
SLH-2B



SINGER

2515



MAQUINA

15K, 16K, 16V, 68-39, 69

125292



MAQUINA

15-88, -90, -91

6028
TF1



MAQUINA

17-16, 17, 17U

58669
HSH-7-3



MAQUINA

7-31, 33, 56

12393



MAQUINA

31-15, 31, 331K

CS-028091-00C



MAQUINA

45B6BT; 45B8BT

98622
DD1



MAQUINA

45K

40028



MAQUINA

269W

418045



MAQUINA

469U



ADLER

098151784



MAQUINA

91, 98

068150784



MAQUINA

0,67 0,68

068150804



MAQUINA

0,67 0,68

9076



MAQUINA

0,69-1296

9076MF



MUELLE DE FRENADO

MAQUINA

0,69-1296

167001784



MAQUINA

167,168,268

396150784



MAQUINA

196, 296, 396

103118



MAQUINA

265



ALFA

112327



INCLINADA

MAQUINA
127, 157, 205, etc.

112255



RECTA

MAQUINA
127,157

114757



MUELLE DE FRENADO

MAQUINA
201, 204, 205, etc.

18348



MAQUINA
188

10159



MAQUINA
184

218210



MAQUINA
102,109

218232



MAQUINA
102,109

125291



MAQUINA
40

15277



MAQUINA
20



BARATTO

BC-HBA-1



MAQUINA
FESTONES

BARUDAN

KF220302



MAQUINA
BEMR, BEMS, BEMX

KF220370



MAQUINA
BEL,BELL,BEM,BEH,
BEJ,BEU,BEUF

KF220370S



MUELLE DE FRENADO

MAQUINA
BEL,BELL,BEM,BEH,
BEJ,BEU,BEUF

KF220890



MAQUINA
BEMR,BEMS,BEMX



BROTHER

100369-001



MUELLE DE FRENADO

MAQUINA
714, 715, 716, 755, 790, 791

148350-101



MAQUINA
714, 715, 716, 755, 790, 791

107097-101



MAQUINA
814

147790-001



GRAN CAPACIDAD

MAQUINA
745, 797

152688-001



MAQUINA
430, 430H

**S07741-001
CP-G12C**



MAQUINA
845

**159157-001
BC-DP815**



MAQUINA
815

**151041-001
CP-12C**



MAQUINA
835

COLUMBIA

52237



MAQUINA
430

52237NBL



MUELLE DE FRENADO

MAQUINA
430



CONSEW

43725



MAQUINA
7140

18045



GRAN CAPACIDAD

MAQUINA
206RB

52237



MAQUINA
210, 230, 310

52237NBL



MUELLE DE FRENADO

MAQUINA
210, 230, 310, 290

35575



**MUELLE DE FRENADO
GRAN CAPACIDAD**

MAQUINA
175

502530



MAQUINA
347

224441NBL



MUELLE DE FRENADO

MAQUINA
7130/4

15850-09
CP-12MC(5)



GRAN CAPACIDAD

MAQUINA
327RB-1



DÜRKOPP

2111115 CLOSED



CERRADA

MAQUINA
211, 212, 213, 214, 215,
218, 265

2111115MF CLOSED



CERRADA
MUELLE DE FRENADO

MAQUINA
211, 212, 213, 214, 215,
218, 265

265965
BC-HDU265



ABIERTA

MAQUINA
211, 212, 213, 214, 215,
218, 265

2111115MF



ABIERTA
MUELLE DE FRENADO

MAQUINA
211, 212, 213, 214, 215,
218, 265

211-275



MAQUINA

211, 213, 214, 215, 218

211-275MF



MUELLE DE FRENADO

MAQUINA
211, 213, 214, 215, 218

211-926
BC-HDU211(1)



MUELLE DE FRENADO

MAQUINA
271

249-369
BC-HDU249



MAQUINA

248,249,543,549,380

265772



GRAN CAPACIDAD

MAQUINA
265

271771 / 271150144



MAQUINA

271, 272

2711034



GRAN CAPACIDAD
MUELLE DE FRENADO

MAQUINA
271

5701243/A



MUELLE DE FRENADO

MAQUINA
560, 570



DÜRKOPP

BC-HDU511



MAQUINA

551,555

5565044
BC-HDU556



MAQUINA

556

ELTAC

522456
BC-HSM



GRAN CAPACIDAD

MAQUINA

1250, 1600

BC-DBM 1



GRAN CAPACIDAD

MAQUINA

LSC-8BLV

HUSQVARNA

52237NBL



MUELLE DE FRENADO

MAQUINA

263

52237
BC-TA1



MAQUINA

263



JUKI

B-1810-761-OAO
BC-DP2(2)



MAQUINA
761, 762, 763

B-1828-980-OAO



MAQUINA
LK280,980

B-1828-980-OAB



MAQUINA
LK1850

B-1837-201-OAO
BC-HSM



MAQUINA
227,552,553,555

B-1837-201-OAOS



MUELLE DE FRENADO

MAQUINA
227,552,553,555

B-1836-232-OAO



MAQUINA
LK232-322

B-1837-526-OAO
CP-12MC



MAQUINA
LH-527, LUH-521,526,527

137-29769



MAQUINA
LBH-790-4

B-1810-771-OAO
BC-DP2(771)



MAQUINA
LBH-771-774,781-784

102-08254
CP-62C



MAQUINA
LH1162

101-10252
CP-12(2)



MAQUINA
LH-1152-4

102-31553
CP-M82 C



MAQUINA
LH-1182



JUKI

BC-DBM(Z1)NBL



**GRAN CAPACIDAD
MUELLE DE FRENADO**

MAQUINA
LZH-1290

100-80059



CORTAHILOS

MAQUINA
LZH-1290-4

**100-34056
BC-D57**



MAQUINA
LZ-1280-1285-1287

MITSUBISHI

**P976015/MF25E0125
BC-HSM**



GRAN CAPACIDAD

MAQUINA
DY330-22, DY337

**MN28B0125
CP-12MC**



MAQUINA
DN275-20
LT2-240-BOB

**W461742/MF10E0125
BC-TA1**



MAQUINA
DB126,130,170,189

**MG40E0125
BC-TA1 (NBL)**



**MUELLE DE FRENADO
GRAN CAPACIDAD**

MAQUINA
DY-340-22BZ,
DB-189-22BZ

MS17A0125



GRAN CAPACIDAD

MAQUINA
PLK-1006

MSO1A0125



MAQUINA
PLK-109

CP-12MC (3)



MAQUINA
LT2-250



NECHI

971927-4-00



MAQUINA
902,931,932

971923-4-00



MAQUINA
910,911,930

971849-4-00



MAQUINA
840

227526-4-00



MUELLE DE FRENADO

MAQUINA
885

554577-4-00
BC-HDU211(NBL)



MUELLE DE FRENADO

MAQUINA
880

971878-4-00



MAQUINA
802,812,830,881,885

222528-4-00



MUELLE DE FRENADO

MAQUINA
802,812,830

971964-4-00
BC-HP3114



MAQUINA
400-408,1601,1602



PFAFF

8243
BC-HPF3114



MAQUINA

114, 115, 116, 3114

3115, 3116

10159
CP-HPF151



MAQUINA

141-146,191-196

441-448, 471-493

18348
CP-HPF545



GRAN CAPACIDAD

MAQUINA

540, 546, 551, 555, 591,

596, 720, 1241-1246

9076
BC-HPF134



MAQUINA

234, 331, 335, 463, 480,

461,, 561, 563

9076MF
~~BC-HPF134(NBL)~~



MUELLE DE FRENADO

MAQUINA

234, 331, 335, 463, 480,

461,, 561, 563

629679



MAQUINA

417-419, 3518

24423



MAQUINA

3135, 3136, 3334, 3335

130590



MAQUINA

3337

91-262377-91



MAQUINA

1183

118414
CP-HPF442TR



CORTAHILOS

MAQUINA

441-900 - 448-900

140287
CP-HPF1242



CORTAHILOS
GRAN CAPACIDAD

MAQUINA

1242, 1244, 1246



REFREY

9011260
CP-HPF151



MAQUINA
901, 902

901260
BC-TA1(NBL)



MAQUINA
906,910,918

901260S



MUELLE DE FRENO

MAQUINA
906,910,918

911260
BC-HDU211(NBL)



MAQUINA
920 a 923, 925, 927

BC-HSM



MUELLE DE FRENO
GRAN CAPACIDAD

MAQUINA
905

911260S



MUELLE DE FRENO

MAQUINA
920 a 923, 925, 927

530198
BC-HSM(NBL)



MUELLE DE FRENO
GRAN CAPACIDAD

MAQUINA
1920-1923, 1925, 1927

931260
BC-DP2(2)



MAQUINA
930

19011260/41



MAQUINA
1901, 1901/41

B-815-1



MAQUINA
430, 427



RIMOLDI

8243
BC-HPF3114



MAQUINA

800

9076
BC-HPF134



MAQUINA

100, 120, 140, 180

9076MF



MUELLE DE FRENADO

MAQUINA

100, 120, 140, 180

SANTONI

CT00789/0 MF



MUELLE DE FRENADO

MAQUINA

MFA-84

63913B



MAQUINA

MFA-84



SEIKO

9076
BC-HPF134



MAQUINA
LSC

BC-DBM 1



GRAN CAPACIDAD

MAQUINA
LSC-8BLV

18045
BC-STH



GRAN CAPACIDAD

MAQUINA
STH

69672



TEFLON

MAQUINA
LSC



SINGER

15277
BC-HA1



ANIQM
9,88,5

62740



ANIQM
K3, B

541678
BC-TAZ14



ANIQM
U02

52237
BC-TA1



ANIQM
2,20,55
5,3,3,6

52237MF



MUELLE DE FRENADO

ANIQM
2,20,55
5,3,3,6

224441
BC-DP2(2)



ANIQM
V01, G01

43725



ANIQM
V062

173058



ANIQM
0,9,6

530198



0,9,6

ANIQM
0,9,6, 0,9,6

502530
BC-DP57



ANIQM
G754

418047



ANIQM
L064

1650-519/239728



ANIQM
V063



SINGER

125291



MAQUINA
15-88,15-90,15-91

39624



MAQUINA
71

522533MF



**DOBLE ARRASTRE
MUELLE DE
FRENADO**

MAQUINA
121C,121D,770D,43

149063



MAQUINA
121D200A,300A

103005



MAQUINA
132K, 133K

514241
CP-HPF545S



MAQUINA
211G, 212G

512551
CP-212



MAQUINA
212G, 440

271785
BC-271



MAQUINA
271K



TAJIMA

BC-HTH (NBL)



MAYOR CAPACIDAD
70%>N

MAQUINA
191D

143390



APERTURA ANCHA
MUELLE DE FRENADO

MAQUINA
591D

522456
BC-HSM



GRAN CAPACIDAD

MAQUINA
TMM

H-15



GRAN CAPACIDAD
MUELLE DE FRENADO

MAQUINA
TMM

UNION SPECIAL

CP-12C



MAQUINA
62000

63913A



MAQUINA
61900, 63900

61413E
BC-HUN614



MAQUINA
61200, 61300, 61400 63400

CT00789/0



MUELLE DE FRENADO

MAQUINA
61900, 63900



YAKUMO

52237
BC-TA1



MAQUINA
DSN-178-1

52237NBL



MUELLE DE FRENADO

MAQUINA
DSN-178-1

BC-NJ380



MAQUINA
380, 380B

522456
BC-HSM



GRAN CAPACIDAD

MAQUINA
DSN-178L-3

ADLER

68180



MAQUINA
067, 068

9033



MAQUINA
1296, 069

167180



MAQUINA
167, 168, 267, 467, 767

9033A



ALUMINIO

MAQUINA
069, 1296

61-056



MAQUINA
196, 296, 396

97949



MAQUINA
265

210530



MAQUINA
91, 98

502526



ALUMINIO

MAQUINA
91, 98

220-180



MAQUINA
220

95093

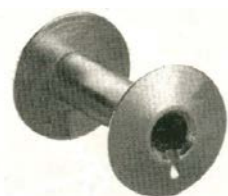

MAQUINA
104, 105

167150270



ALUMINIO

MAQUINA
167, 267, 467, 767

SB-34



MAQUINA
204



ALFA

2518



MAQUINA
20, 40

SB-ALFA



MAQUINA
102, 109

10672



MAQUINA
127, 157, SERIE 200

10672A



ALUMINIO

MAQUINA
127, 157, SERIE 200

45506

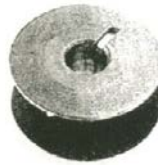

MAQUINA
196, 296, 396

45741



GRAN CAPACIDAD

MAQUINA
265

BARUDAN

KF220410



MAQUINA
BEL, BELL, BEM

H-16



GRAN CAPACIDAD

MAQUINA
BEH, BEJ, BEU, BEUF



BROTHER

117132-001



MAQUINA
755, 756, 757, 781, 790

100376-001



ALUMINIO

MAQUINA
755, 756, 757, 781, 790

117480-001



MAQUINA
814

112781-001



MAQUINA
831, 832, 835

117061-001



MAQUINA
745, 797

150971-001



GRAN CAPACIDAD

MAQUINA
837, 838

100117.001



MAQUINA
430, 430H

145265-001



ALUMINIO

MAQUINA
430, 430H

159158-001



MAQUINA
815



COLUMBIA

204230



MAQUINA

430

204230A



ALUMINIO

MAQUINA

430

CONSEW

15041



GRAN CAPACIDAD

MAQUINA

244, 254, 255, 327RB, 333

10656



MAQUINA

332, 327, 328, 244, 225

18034

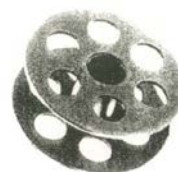

GRAN CAPACIDAD

MAQUINA

206RB, 175

270010

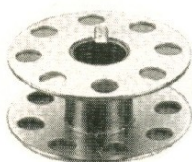

MAQUINA

210, 230, 310

204230A



ALUMINIO

MAQUINA

210, 230, 310

210530



MAQUINA

347

502526

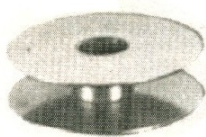

ALUMINIO

MAQUINA

7130/4

23500



MAQUINA

7140



DÜRKOPP

204230



MAQUINA
211, 212, 218, 265

204230A



ALUMINIO

MAQUINA
211, 212, 218, 265

245 1660A



ALUMINIO

MAQUINA
244

249-372



MAQUINA
248, 259, 380, 543, 549

265 789



GRAN CAPACIDAD

MAQUINA
265

555919



MAQUINA
551, 555

556 1603

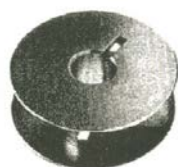

MAQUINA
556

570/1050



ALUMINIO

MAQUINA
560, 570



ELTAC

SB-AL-HSM (CUT)



ALUMIINIO

MAQUINA
1250, 1600

H-16



MAQUINA
1250, 600

HUSQVARNA

204230



MAQUINA
263

204230A



ALUMINIO

MAQUINA
263



JUKI

A-9117-001-000



MAQUINA
232, 222

B-1827-280-000

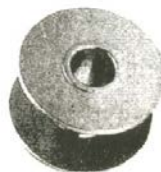

ALUMINIO

MAQUINA
280, 290, LK1850

B-9117-012-000



MAQUINA
227, 552, 553, 555

B-9117-051-000



MAQUINA
512, 515, 517, 518, 562

B-9117-563-000



MAQUINA
LU563

B-1809-761-000



ALUMINIO

MAQUINA
761, 762, 763, LZ-1280

B-9117-057-000



MAQUINA
158, 777, 778

B-1811-771-000



ALUMINIO

MAQUINA
771, 777, 773, 790

100-80604

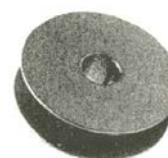

MAQUINA
LZH 1290



MITSUBISHI

W462632



MAQUINA

DB 126, 130, 170

W445964



MAQUINA

DB 286, DN 260, 265

510007



GRAN CAPACIDAD

MAQUINA

DN260, 262, 265

W470215



GRAN CAPACIDAD

MAQUINA

DY 330-22, 337

MA10A0123



**ALUMINIO
GRAN CAPACIDAD**

MAQUINA

PLK-1006

MS01A0123



MAQUINA

PLK - 109



NECCHI

10079



MAQUINA
902, 910, 911,
930, 931, 932

167180



GRAN CAPACIDAD

MAQUINA
910, 916, 925, 955,
956, 957, 977, 928

502526



ALUMINIO

MAQUINA
SERIE 400, 1405
1416, 1601, 1602

210530



MAQUINA
SERIE 400, 1405
1416, 1601, 1602

204230



MAQUINA
802, 812, 830, 832, 835,
860

204230A



ALUMINIO

MAQUINA
802, 812, 830, 832, 835,
860

95093



MAQUINA
631, 632, 633, 640,
641, 642, 643, 644



PFAFF

20240



MAQUINA
3114, 3115, 3116

2030

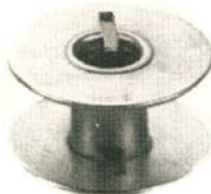

MAQUINA
3334, 3335, 3337

2030A



ALUMINIO

MAQUINA
3334, 3335, 3337

10079



MAQUINA
140, 190, 142, 442, 470, 471, 493

18339



MAQUINA
540, 541, 544, 590, 591, 720

9033



MAQUINA
234, 331, 335, 461, 463, 480, 481, 487, 438, 563

9033A



ALUMINIO

MAQUINA
234, 331, 335, 461, 463, 480, 481, 487, 438, 563

10079A



ALUMINIO

MAQUINA
140, 190, 142, 442, 470, 471, 493

91-120054-05



ALUMINIO

MAQUINA
3116

91-168634-05



ALUMINIO
GRAN CAPACIDAD

MAQUINA
418, 3518

18339A



ALUMINIO
GRAN CAPACIDAD

MAQUINA
1241-1246

91-262437-05



ALUMINIO

MAQUINA
1183



REFREY

9011280



MAQUINA
901, 902

901280



MAQUINA
906, 920, 922, 925, 927

911280



ALUMINIO

MAQUINA
906, 920, 922, 925, 927

18034



GRAN CAPACIDAD

MAQUINA
1920, 1922, 1923, 1925
1927

B-880



MAQUINA
427, 430, 930

931280



GRAN CAPACIDAD

MAQUINA
930

931280A



GRAN CAPACIDAD
ALUMINIO

MAQUINA
930

B-880-AL



ALUMINIO

MAQUINA
427, 430, 930



RIMOLDI

20240



MAQUINA

800

9033



MAQUINA

100, 120, 140

9033A

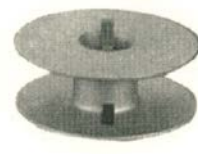

ALUMINIO

MAQUINA

100, 120, 140

SANTONI

204230



MAQUINA

263

204230A



ALUMINIO

MAQUINA

263



SINGER

2518



MAQUINA
15K, 16K, 15-88

2996



MAQUINA
16, 16U, 331K

2073



MAQUINA
17, 17U, 18, 18U.

95093

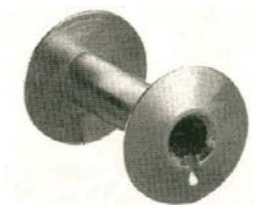

MAQUINA
45K

233939



MAQUINA
51W, 52W, 52K, 118W

40264

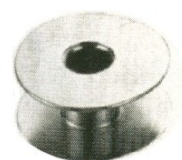

MAQUINA
95, 96, 196, 281, 291,
366, 400, 451, 600

55623



MAQUINA
95, 96, 196, 281, 291,
366, 400, 451, 600, 20U

210530



MAQUINA
107G, 107W

203470



MAQUINA
11W, 211G, 211W
212G, 212W

244750



ALUMINIO
MAQUINA
11W, 211G, 211W
212G, 212W

514201



GRAN CAPACIDAD
MAQUINA
11W, 211G, 211W
212G, 212W

97949



MAQUINA
132K, 133K



SINGER

264645



MAQUINA
144W - 145W

23500



MAQUINA
269W

23500A

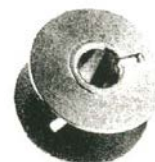

ALUMINIO

MAQUINA
269W

270010



MAQUINA
95, 96, 196, 281, 291, 399,
400, 451, etc.

239729

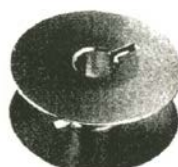

ALUMINIO

MAQUINA
369W141

502526



ALUMINIO

MAQUINA
457G, 271K

418046



ALUMINIO

MAQUINA
469U

BO-HTH (2) AL



MAYOR CAPACIDAD
70% >N

MAQUINA
191D



SEIKO

15041



GRAN CAPACIDAD

MAQUINA
LLW, LLWH, LSW

9033



MAQUINA
LSC

10656



MAQUINA
STW

18034



GRAN CAPACIDAD

MAQUINA
STH

UNION SPECIAL

61212



MAQUINA
61200, 61300, 61400
61900, 63400, 63900

204230A



ALUMINIO

MAQUINA
61200, 61300, 61400
61900, 63400, 63900

62212



MAQUINA
61800, 62200



TAJIMA

18034



GRAN CAPACIDAD

MAQUINA
TMM

YAKUMO

204230



MAQUINA
DSN-178-1, 380(B)

18034



GRAN CAPACIDAD

MAQUINA
DSN-178L-3





MAQUINA DE CORTAR TIRA MS-911B



MÁQUINA DE CORTAR TIRA
MS-911B

Esta máquina automática de corte por
control de longitud y tiene el ajuste a
proporcionar la longitud automática
para asegurar la precisión y la potencia de
corte.
Operación sencilla y rápida de montaje y fácil
mantenimiento. Para trabajos de alto volumen, tanto
de corte como de embalaje.

Modelo	MS-911B
Material	Acero inoxidable
Longitud de corte	0 a 1000 mm
Velocidad de corte	0 a 100 mm/min
Peso	150 kg
Consumo eléctrico	1500 W

MÁQUINA SU LEE ST-360



MAQUINA MANUAL PARA EXTENDER TEJIDOS MR-96



SIERRA CINTA CONTÍNUA MR-92





MAQUINA DE CORTE ALL-STAR AS-100

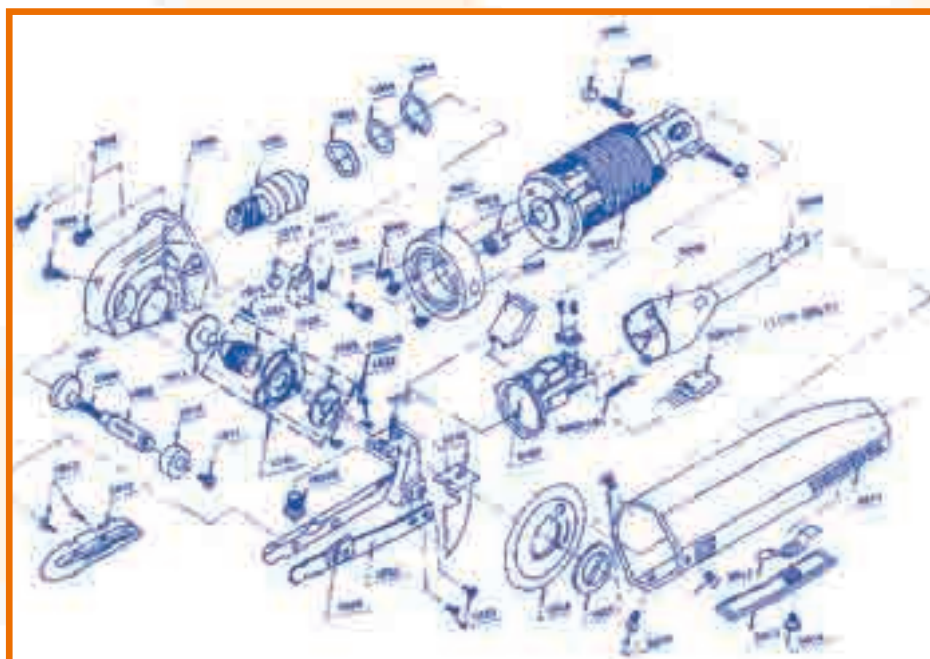

PART NO.	QTY.	DESCRIPTION	PART NO.	QTY.	DESCRIPTION
AS-1000	1	GEAR CASE	AS-1024	1	HELIX GEAR
AS-1001	1	WORM GEAR & BEARING ASSY	AS-1025	1	HELIX GEAR SUPPORT
AS-1002	1	UNDILATED WASHER	AS-1026	1	HEXAGONAL KNIFE
AS-1003	1	WASHER	AS-1027	1	KNIFE LOCK SCREW
AS-1004	1	RETAINING RING	AS-1028	1	KNIFE SUPPORT
AS-1005	2	GEAR CASE TO BODY SCREW	AS-1029	1	TEACHER LASH
AS-1006	1	SHARPENER SHAFTSCREW	AS-1031	1	HELIX GEAR ASSY
AS-1007	1	SHARPENER CAP			
AS-1008	1	SHARPENER SPRING	AS-5000	2	DISC SCREW
AS-1009	1	SHARPENER SHAFT	AS-5001	1	DISC
AS-1010	1	SHARPENER STONE	AS-5002	1	SHAFT COUPLING
AS-1011	1	STONE SCREW	AS-5003	1	MOTOR ASSY (110V or 220V)
AS-1012	1	SHOE	AS-5004	2	MOTOR BRUSH SCREW
AS-1013	2	SHOE SCREW	AS-5005	2	MOTOR BRUSH
AS-1014	1	HELIX GEAR SHAFT	AS-5006	1	MICRO SWITCH
AS-1015	1	OILER SUPPORT PIN	AS-5007	1	MICRO SWITCH HOUSING
AS-1016	1	OILER FELT	AS-5008	1	SHEATH
AS-1017	1	OILER HOUSING	AS-5009	1	POWER SUPPLY CABLE
AS-1018	1	OILER SPRING	AS-5010	1	HOUSING MOUNTING SCREW
AS-1019	1	OILER SCREW	AS-5011	1	HOUSING
AS-1020	1	LEG	AS-5012	1	ON-OFF HANDLE SPRING
AS-10205	1	LEG SCREW	AS-5013	1	ON-OFF HANDLE
AS-1021/28	1	CUTTING BLADE W CARBIDE	AS-5014	1	ON-OFF HANDLE SCREW
AS-1022	2	KNIFE SUPPORT TO CASE SCREW	AS-5003-18	2	MICRO SWITCH HOUSING SCREW
AS-1023	1	KNIFE SUPPORT SCREW	AS-5003-21	1	BRIDGE RECTIFIER
AS-1023	2	CUTTING BLADE SCREW			



MAQUINA CUT-AIR

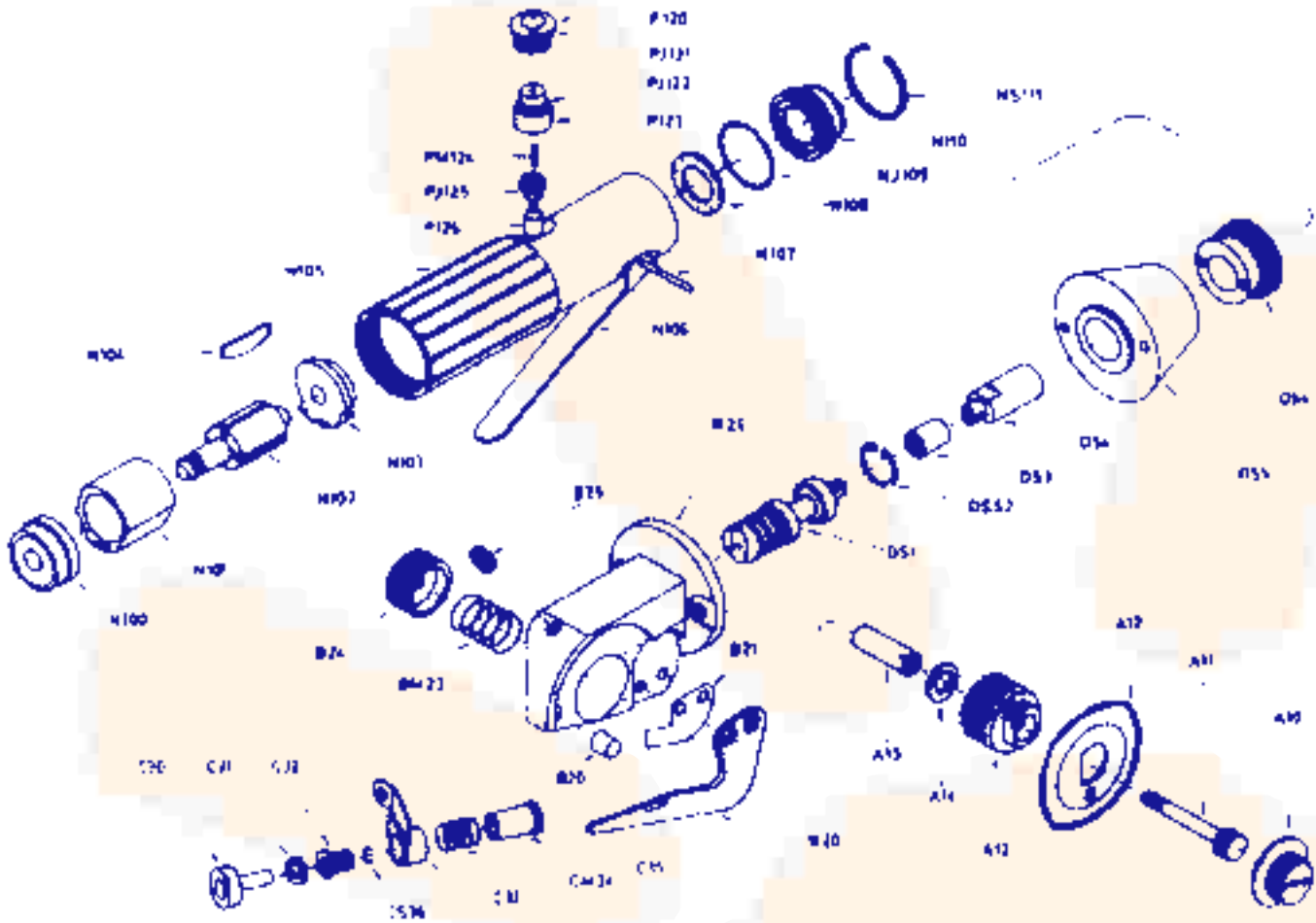

MARCA	Nº PIEZA	MARCA	Nº PIEZA	MARCA	Nº PIEZA	MARCA	Nº PIEZA
A10	4C1-194	B20	726C1-5	C30	541C1-22	D51	653C1-1
A1	720C1-42	B21	120C1-40	C31	12C15-57	DS2	18C6-35
A12	80C1-123	B22		C32	21C5-4	D53	822C1
A13	524C1-10	BM23	34C10-140	C33	636C1-3	D54	200C1-11
A14	12C15-74	B24	4C3-12	CM34	34C10-131	D55	29C6-142
A15		B25	54C4-35	C35	63C3-21	D56	
		B26	647-C1-4	C36	18C6-23		



RSD-100



CDZ-3



SC-500

MAQUINA DE CORTE ALL-STAR AS-100





CUCHILLAS SIERRA CINTA CONTINUA



Filo liso

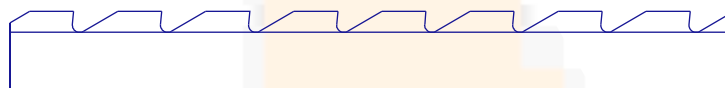

Filo mixto



Filo sierra



Filo cóncavo

RACODI M.R92	4,88 m.
OTEMAN	3,84 m.
RIBA-120	4,90 m.
RIBA-B	3,42 m.
RIBA-E110	4,25 m.
RIBA-E125	5,23 m.
RIBA-P	2,57 m.
RIMOLDI	4,92 m.
ROVI	3,75 m.
ROVI-ML	4,15 m.
SERTEX	3,88 m.
FERLUS-100U	4,20 m.
AUTEX-A75	4,46 m.
AUTEX-A105	5,03 m.
BULLMER	2,88 m.
BULLMER-770	4,05 m.
BULLMER-778	5,28 m.
BYX	3,23 m.
BYX	3,75 m.
BYX	3,90 m.
HOGGS	4,60 m.
HOGGS	5,50 m.
KURIS	4,92 m.

LIMAS DIAMANTADAS

PLANA PARALELA
VA4099801 5297

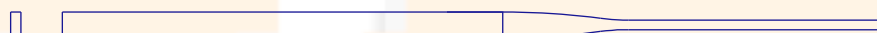

TRIANGULAR
VA40998011 5271



CUADRADA
VA4099803 5481

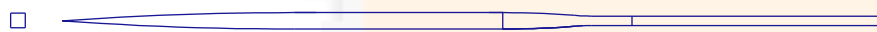

MEDIA CAÑA
VA4099804 5335



REDONDA
VA4099805 5333



FORMA CUCHILLO
VA40998010





CUCHILAS

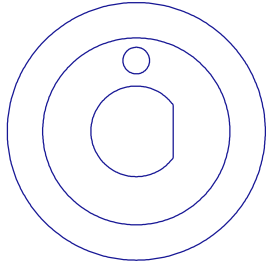

EASTMAN
REF. 80C1-114
CH622

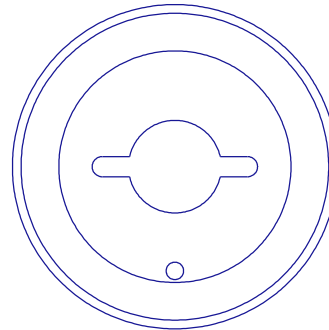

REF. CH-1656-C
CH996

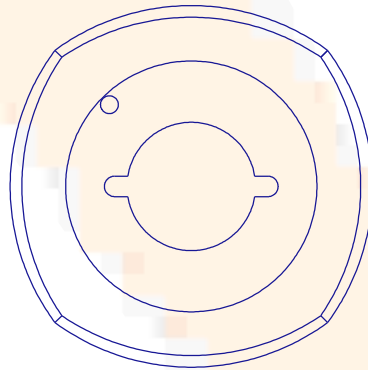

KURIS
REF. BOM-60
CH632

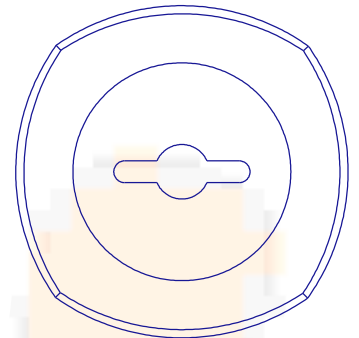

WOLF-HOOGS
REF. SF-201
CH651

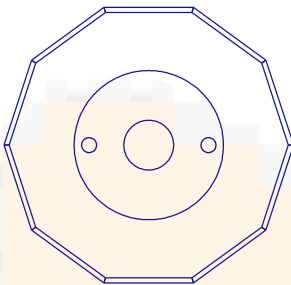

BULLMER
REF. 0470/1
CH691

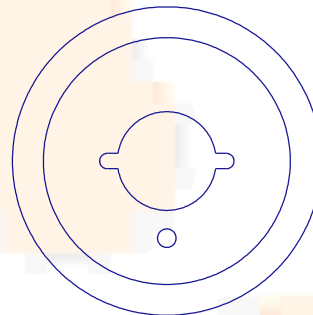

SUPREMA
M-702
CH623

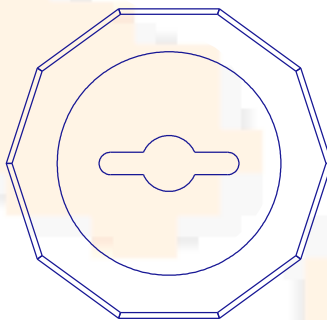

HOOGS
REF. GOLIATH
REF. CH641

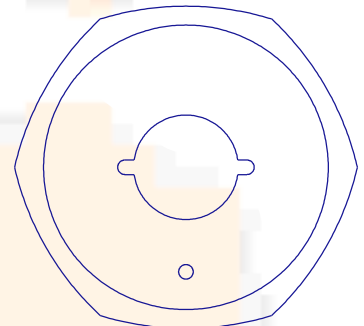

KURIS
REF. 15210
CH992

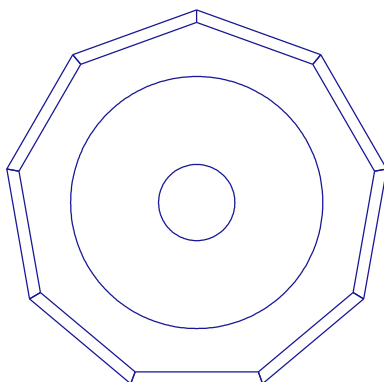

CH991

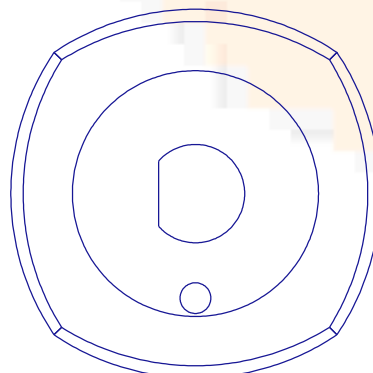

CH995

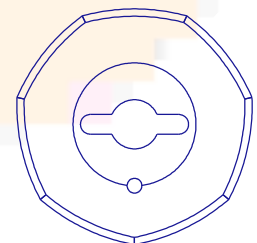

HOOGS
MS-90/1-MS-55
CH672



CUCHILLAS

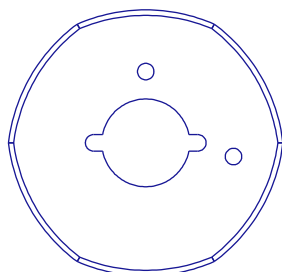

MAIMIN RS-232
KURIS NOVITA
CH631

M-700
CH3201
SUPREMA

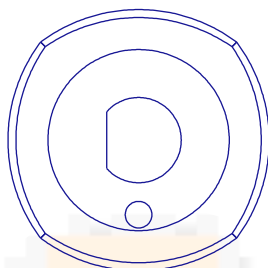

EASTMAN
BOCI-123
CH621

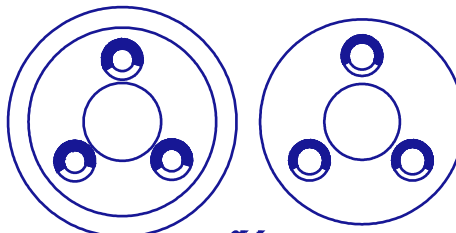

CF-3
CH998

MS-911-B1
MA00002

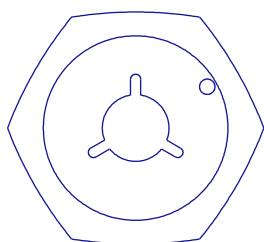

AS-1026
CH997



TORRES
CH624



Moleteada



Lisa



CV4099801



LECTRA
CH999

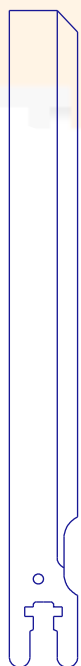

MAIMIN
CV6806HSS 6"
CV6808HSS 8"
CV6810HSS 10"

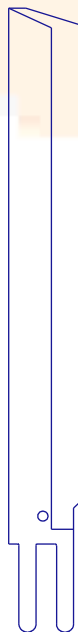

EASTMAN
HITAKA KM
CV6205HSS 6"
CV6206HSS 6"
CV6208HSS 8"
CV6210HSS 10"
CV6208R 6"
CV6208R 8"
CV6210R 10"



WOLF
CV6506HSS 6"
CV6508HSS 8"
CV6510HSS 10"



EASTMAN
HITAKA KM
CV62W06HSS 6"
CV62W08HSS 8"
CV62W10HSS 10"

C U C H I L L A S V E R T I C A L E S



CUCHILLAS CIRCULARES

Bullmer

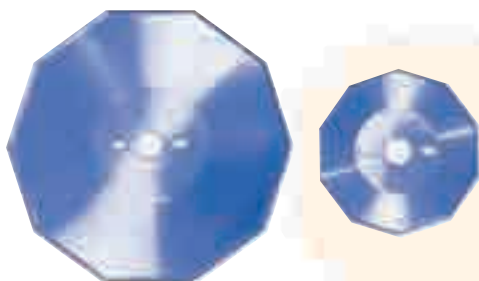

Eastman

Diverse

Hoogs



Máquina modelo	Tipo	Forma de la cuchilla	Ø est. mm	Taladro	Espesor
602	0250/1	10 cantos	50	14x8x2,5	1,0
604,801	0470/1	10 cantos	59	10	1,0
601,605	0570/1	10 cantos	79	10	2,0
607	0674/1	circular	100	10	1,5
606,607,AV300	0670/1	10 cantos	100	10	2,0
	675/1	4 arcos	100	10	2,0
	970	4 arcos	11	15	1,5
	840R	circular	126	45	1,0
	840K	10 cantos	126	45	1,0

Máquina modelo	Tipo	Forma de la cuchilla	Ø est. mm	Taladro	Espesor
123	Buzzaird	4 arcos	48,8		
147	2 1/4"	Chickadee	circular	57	
149	2 1/4"	Chickadee	6 arcos	57	
114	2 1/2"	BBB 25/			
	BBR25	circular	63,5		
84	3 1/4"	Falcon III			
	BBB 32	circular	82		
	3 1/2"	circular	90		
59	4 "	Falcon IV			
	Track,Robin	circular	101,6		
101	5"	circular	127		
60	5 1/4"	548	circular	133,6	
	5 1/2"	circular	140		
39	6"	548,562, 547	circular	152,6	
	7"	circular	178		
77	7 1/2"	562,567	circular	190	

Máquina modelo	Tipo	Forma de la cuchilla	Ø est. mm	Taladro	Espesor
Consew Tuffy 508		4 arcos	65		
Caron		circular	100		
KM (RS100)		circular	100		
KM (RS100) OCTA		8 arcos	100		
Allstar 100		6 arcos	50		

Máquina modelo	Tipo	Forma de la cuchilla	Ø est. mm	Taladro	Espesor
Piccolo, Liliput, Favorit		circular	50	25x10x4	1,2
Piccolo, Liliput, Favorit		10 cantos	50	25x10x4	1,2
Piccolo, Liliput, Favorit		4 arcos	50	25x10x4	1,2
Piccolo, Liliput, Favorit		7 arcos	50	25x10x4	1,2
IAK,IAG,Goliath		circular	50	25x10x4	1,2
IAK,IAG,Goliath		4 arcos	60	25x10x4	1,2
IAK,IAG,Goliath		10 cantos	60	25x10x4	1,2
Z+St		circular	60	25x10x4	1,5
Z+St		4 arcos	11	20x10x4	1,5
Z+St		10 cantos	11	25x10x4	1,5
X-130, X-130-N		circular	11	25x10x4	1,5
X-130, X-130-N		4 arcos	130	25x10x4	1,5
X-130, X-130-N		10 cantos	130	25x10x4	1,5



CUCHILLAS CIRCULARES

Kuris



Máquina modelo	Tipo	Forma de la cuchilla	Ø est. mm	Taladro	Espesor
Novita	15780	circular	50	1	1,0
Novita	16110	6 arcos	50	1	1,0
Novita	16120	8 arcos	50	1	1,0
BOM 60		circular	60	22	1,0
BOM 60	16000	4 arcos	60	22	1,0
BOM 30/80		circular	80	22	1,0
BOM 30/80	16010	4 arcos	80	22	1,0
BOM 30/80		6 arcos	80	22	1,0
BOM 30/80		8 arcos	80	22	1,0
BOM 100		circular	100	22	1,0
BOM 100	16022	4 arcos	100	22	1,0
BOM 100		6 arcos	100	22	1,0
KRH 10	15710	circular	100	35	1,2
KRH 10		4 arcos	100	35	1,2
KRH 12, KRT 120	15720	circular	120	35	1,2
KRH 12		4 arcos	120	35	1,2
KRH 15	15730	circular	150	35	1,6
KRH 15		4 arcos	150	35	1,6
KRH 20	15740	circular	200	40	2,2
KRH 20		4 arcos	200	40	2,2
Champion CRA		circular	100	8	1,3

Maimin

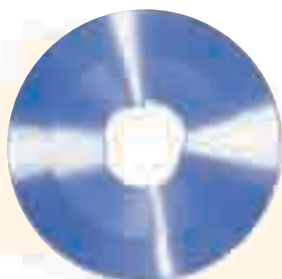

Máquina modelo	Tipo	Forma de la cuchilla	Ø est. mm	Taladro	Espesor
Minishear		circular	50	16	
Minishear		6 arcos	50	16	
Minishear		8 arcos	50	16	
ACD 2 1/2"		circular	63,6	21,6	1,0
ACDC 4"		circular	102	40	1,0
ACDC 5"		circular	127	40	1,2
ACDC 5 1/4"		circular	133,5	51,8	1,3
ACDC 6"		circular	152,5	58,2	1,4
ACDC 7"		circular	178	58,2	1,4

Suprema

Máquina modelo	Tipo	Forma de la cuchilla	Ø est. mm	Taladro	Espesor
M 702		circular	50		
M 700		6 arcos	50		
M 703		8 arcos	50		
R742		circular	80		
R741		6 arcos	80		
R740		8 arcos	80		
R 1512		circular	100		
R 1514		4 arcos	100		
R 1513		6 arcos	100		

Wolf



Máquina modelo	Tipo	Forma de la cuchilla	Ø est. mm	Taladro	Espesor
PUP 25260		4 arcos	52,5	17,6	1,0
SRN 2 1/2"		circular	64		1,0
Clipper 4"	23	circular	102	31,75	1,0
Clipper 4 2/4"	22	circular	121	42,5	1,0
Blazer 5 1/4"	21	circular	134	42,5	1
SLIM JIM 5 1/4"	24	circular	134	50	1,0
Blazer 6"		circular	153	40	1,2
Blazer-0 6"	16	circular	153	50,8	1,2
Blazer 7"	18	circular	178	50,8	1,4
Blazer-0 8"		circular	203	50,8	1,4
BIG-0 10"		circular	254	50,8	1,7



MAQUINA DE REPUNTAR

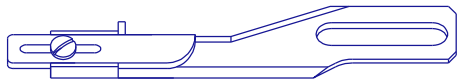

VA1113801

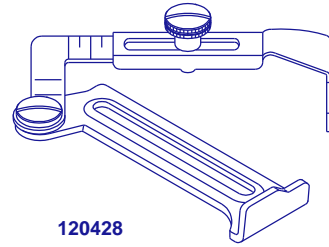

120428
VA40998049



G-20
VA40998202

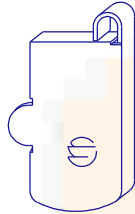

MG25873
VA73013

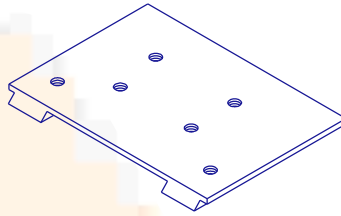

VA4070801

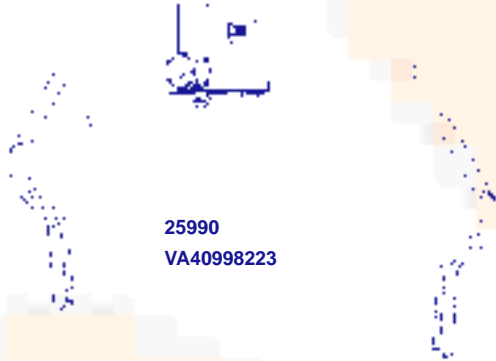

25990
VA40998223

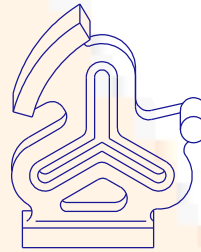

25873
VA40998217

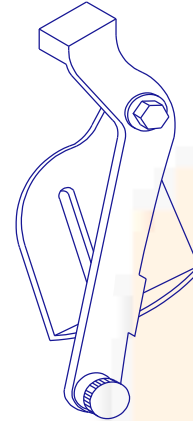

VA40998024

...DE MORRONGAR

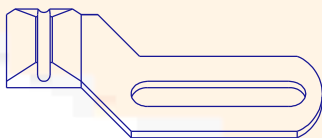

VA4040201

...DE SOBRECARGA

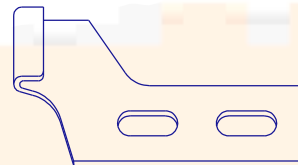

VA4040202

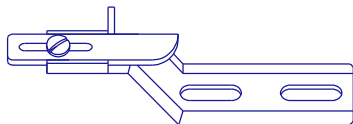

RIMOLDI
VA1112801

...DE BORAS

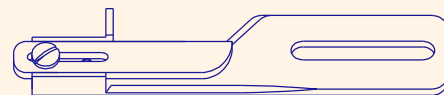

RIMOLDI. MAQ. MORRO
VA1199147

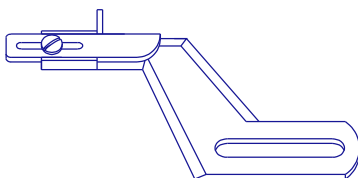

YAMATO
VA2240201

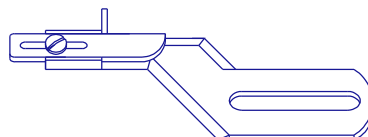

KANSA
VA2040803

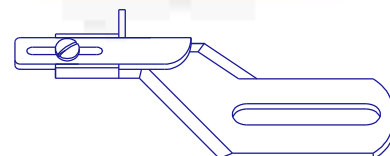

PEGASUS
VA2940201



GUIA DE TIRA EMPOTRADA

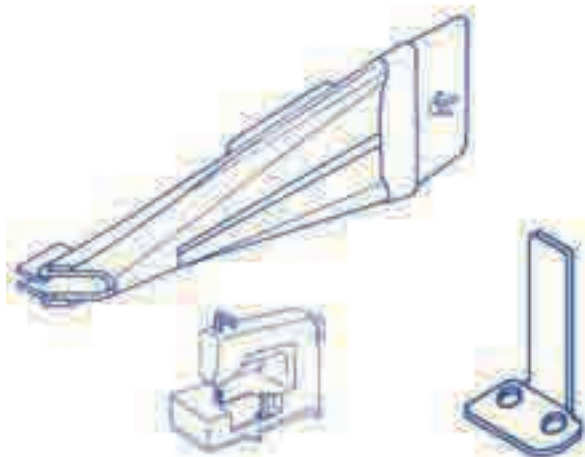

- B12-3E/25x9
- B12-3E/30x11
- B12-3E/35x14
- B12-3E/40x16
- B12-3E/45x19
- B12-3E/50x21
- B12-3E/55x24
- B12-3E/60x26
- B12-3E/65x29
- B12-3E/70x31
- B12-3E/75x34
- B12-3E/80x36
- B12-3E/85x38
- B12-3E/90x40
- B12-3E/100x45

- B12-4E/25x7
- B12-4E/30x9
- B12-4E/35x10
- B12-4E/40x12
- B12-4E/45x14
- B12-4E/50x17
- B12-4E/55x20
- B12-4E/60x23
- B12-4E/65x25
- B12-4E/70x27
- B12-4E/75x29
- B12-4E/80x32
- B12-4E/85x34
- B12-4E/90x36
- B12-4E/100x40

GUIA DE TIRAS DE SOBREPILATO

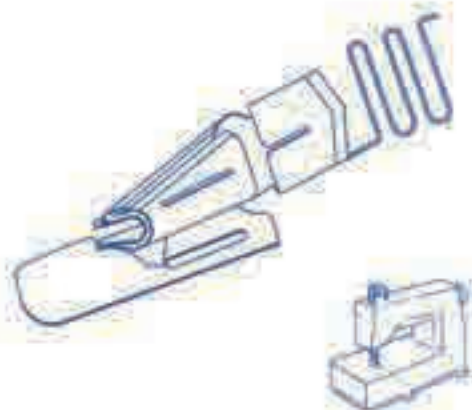

- B12-3/25x9
- B12-3/30x11
- B12-3/35x14
- B12-3/40x16
- B12-3/45x19
- B12-3/50x21
- B12-3/55x24
- B12-3/60x26
- B12-3/65x29
- B12-3/70x31
- B12-3/75x34
- B12-3/80x36
- B12-3/85x38
- B12-3/90x40
- B12-3/100x45

- B12-4/25x7
- B12-4/30x9
- B12-4/35x10
- B12-4/40x12
- B12-4/45x14
- B12-4/50x17
- B12-4/55x20
- B12-4/60x23
- B12-4/65x25
- B12-4/70x27
- B12-4/75x29
- B12-4/80x32
- B12-4/85x34
- B12-4/90x36
- B12-4/100x40



AT24711

CODIGO	PULGADAS	MEDIDA
VA4099848	1/8"	3,2 mm
VA4099847	3/16"	4,8 mm
VA4099852	1/4"	6,4 mm



S123A / S124A			S123B / S124B		
MEDIDA	SALIDA	ENTRADA	MEDIDA	SALIDA	ENTRADA
1/4"	6 mm	18 mm	1/4"	6 mm	24 mm
5/16"	8 mm	24 mm	5/16"	8 mm	32 mm
3/8"	10 mm	28 mm	3/8"	10 mm	38 mm
1/2"	13 mm	34 mm	1/2"	13 mm	44 mm
5/8"	16 mm	42 mm	5/8"	16 mm	52 mm
3/4"	20 mm	50 mm	3/4"	20 mm	60 mm
7/8"	23 mm	56 mm	7/8"	23 mm	66 mm
1"	25 mm	60 mm	1"	25 mm	70 mm



GUIA DE VIVOS DE OWERLOCK



REFERENCIA

- B65-14
- B65-16
- B65-18
- B65-19
- B65-20
- B65-22
- B65-25
- B65-30
- B65-35
- B65-40
- B65-45

GUIA DE VIVOS DE OWERLOCK CON OREJA

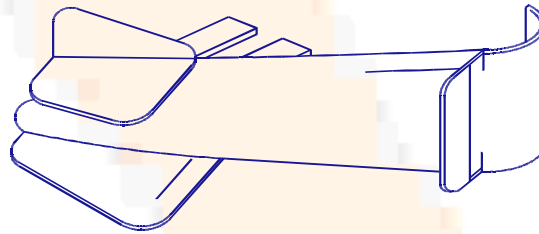

REFERENCIA

- B65-E-14
- B65-E-16
- B65-E-18
- B65-E-19
- B65-E-20
- B65-E-22
- B65-E-25
- B65-E-30
- B65-E-35
- B65-E-40
- B65-E-45
- B65-E-50

GUIA DE VIVOS AEREA

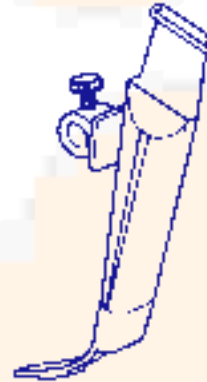
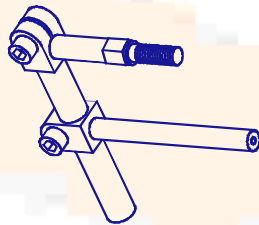

REFERENCIA

- B67-15
- B67-20
- B67-25
- B67-30

SOPORTES GUIA DE VIVOS OWERLOCK

RIMOLDI
G0432
VA4040207

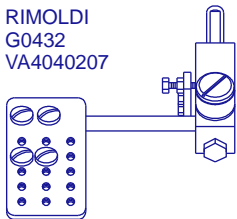

BROTHER
G0439
VA4040208

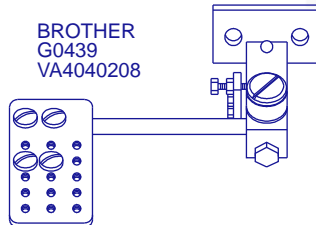

JUK
G0443
VA4040209

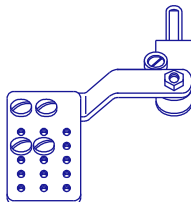

W&G
G0446
VA4040200

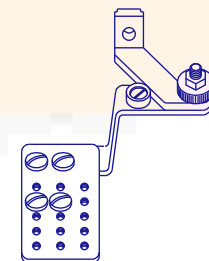
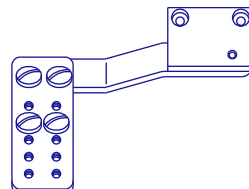

PEGASUS
SIRUBA
WILLCOX & GIBBS (Nueva)
G0447
VA4040210



GUIA PARA BANDAS

REFERENCIA

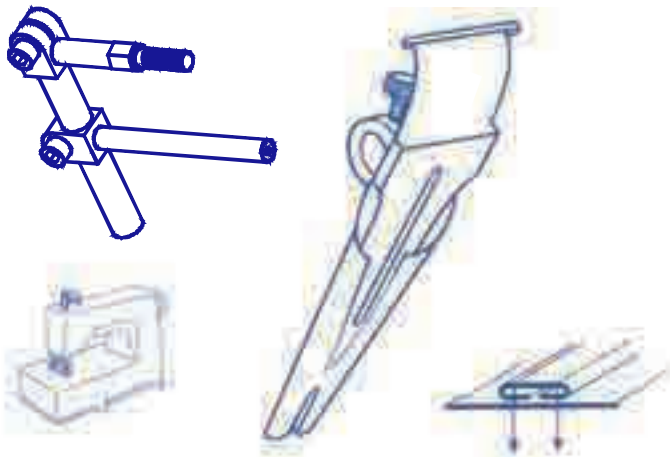

B68/12x6	B68/35x17
B68/14x7	B68/38x19
B68/16x8	B68/40x22
B68/18x9	B68/44x26
B68/20x10	B68/47x29
B68/22x11	B68/48x31
B68/24x12	B68/50x32
B68/25x12	B68/51x34
B68/26x13	B68/54x36
B68/28x14	B68/58x41
B68/30x15	B68/60x42
B68/32x16	B68/73x55

GUIA DE BORAS PARA BAÑO

AJUSTABLE DE:

10 mm hasta 20

REFERENCIA

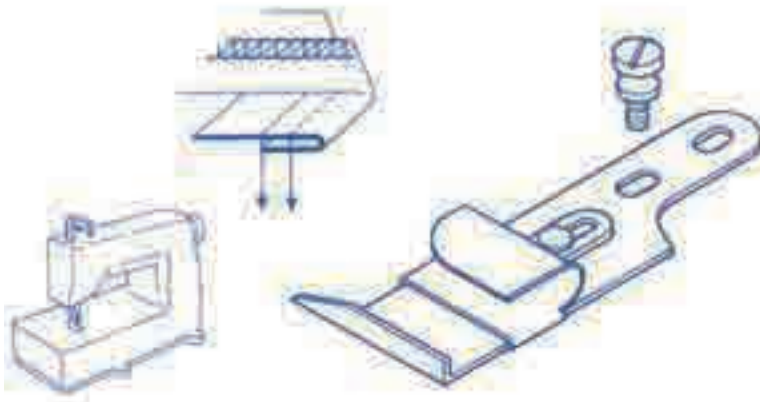

G-G0209—>310030
G-300920-0—>300920-0-10

GUIA DE CAMALES



MR23



**GUIA DE CAMALES YAMATO
- U.SPECIAL**

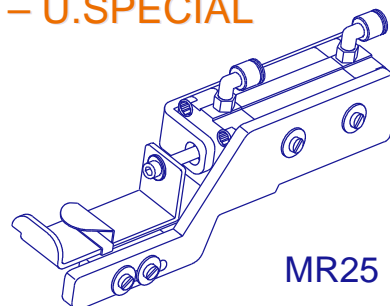

MR25

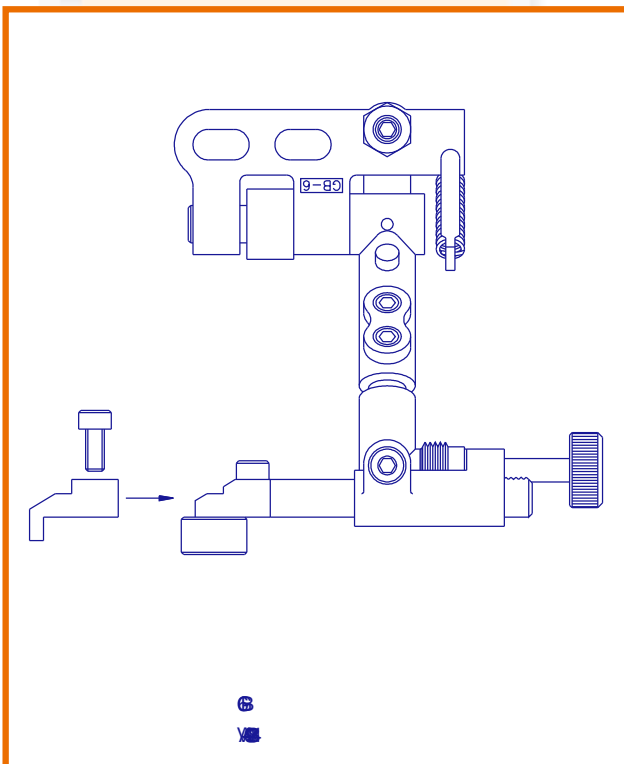

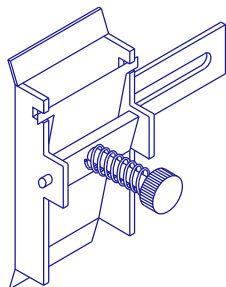

REFERENCIA	MEDIDA	PULGADAS
G0431-8	8 mm	5/16"
G0431-10	10 mm	3/8"
G0431-12	12 mm	1/2"
G0431-15	15 mm	5/8"
G0431-20	20 mm	3/4"
G0431-25	25 mm	1"
G0431-30	30 mm	1-3/16"
G0431-35	35 mm	1-3/16"
G0431-40	40 mm	1-9/16"

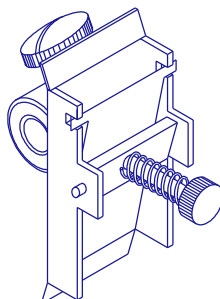

REFERENCIA	MEDIDA	PULGADAS
G0431/1-8	8 mm	5/16"
G0431/1-10	10 mm	3/8"
G0431/1-12	12 mm	1/2"
G0431/1-15	15 mm	5/8"
G0431/1-20	20 mm	3/4"
G0431/1-25	25 mm	1"
G0431/1-30	30 mm	1-3/16"
G0431/1-35	35 mm	1-3/16"
G0431/1-40	40 mm	1-9/16"

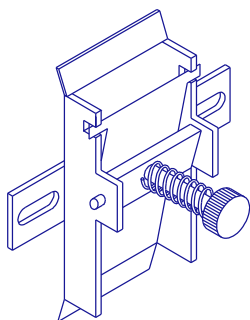

VA40998017

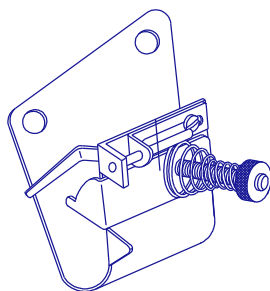

457T-1
VA4099815

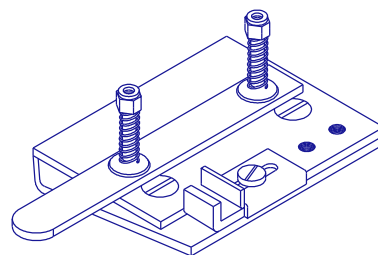

VA40998022

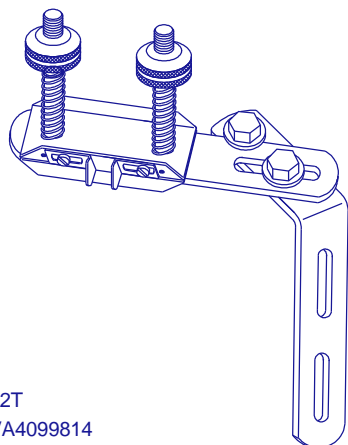

12T
VA4099814

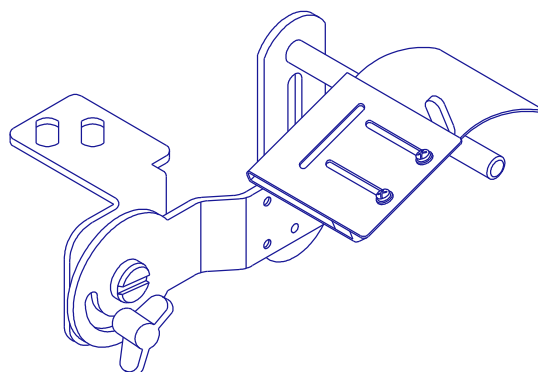

212TA
VA4099830

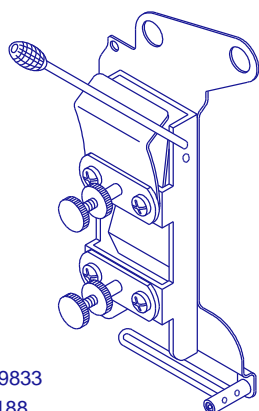

457ET
VA4099833
457G-188
VA4099832

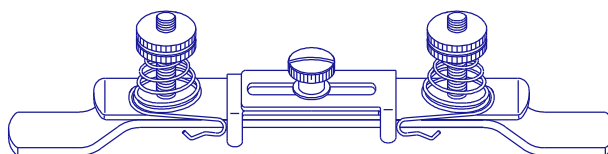

AP-11E
VA40998222

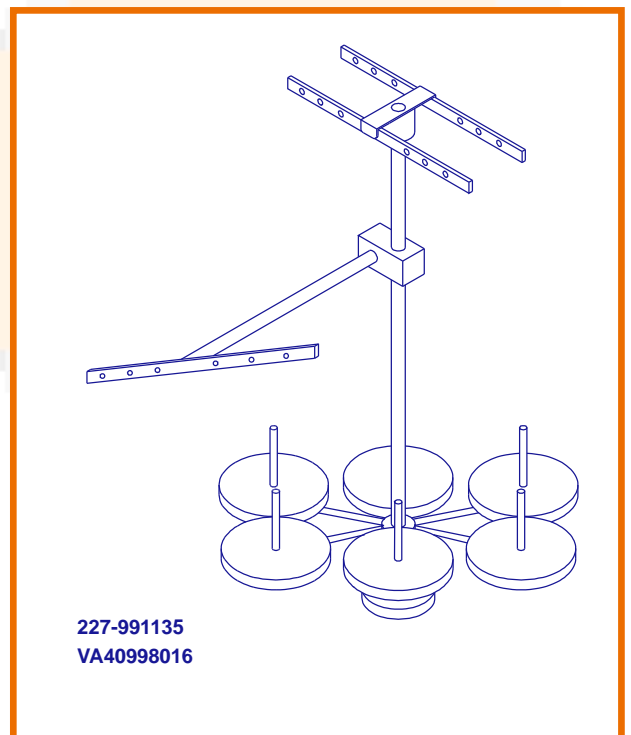
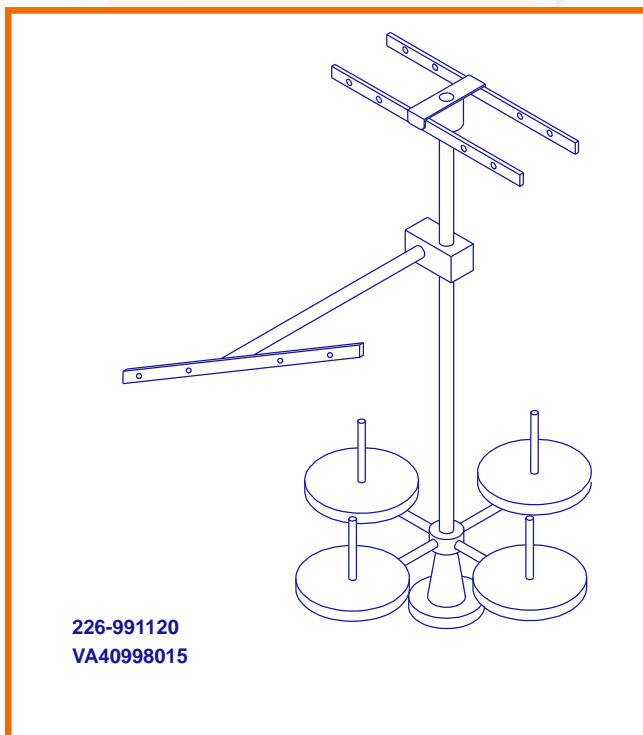
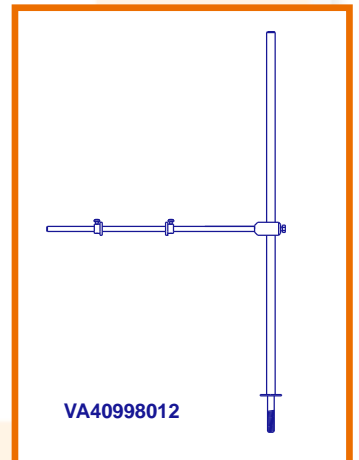
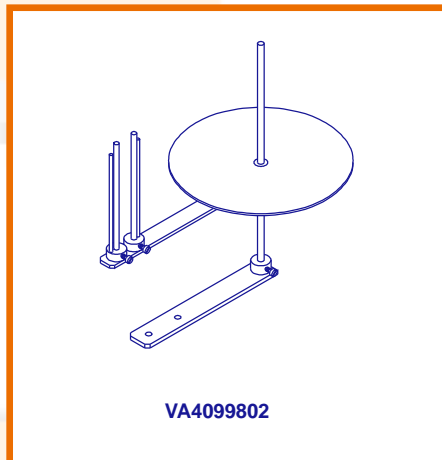
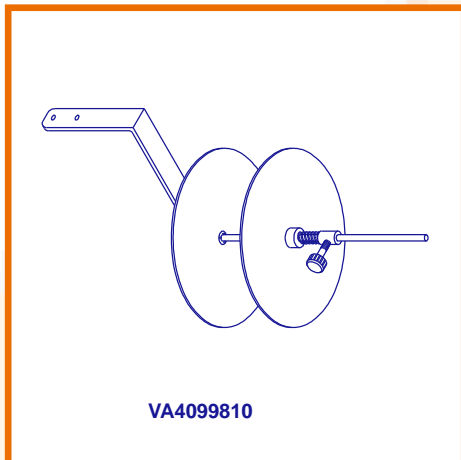
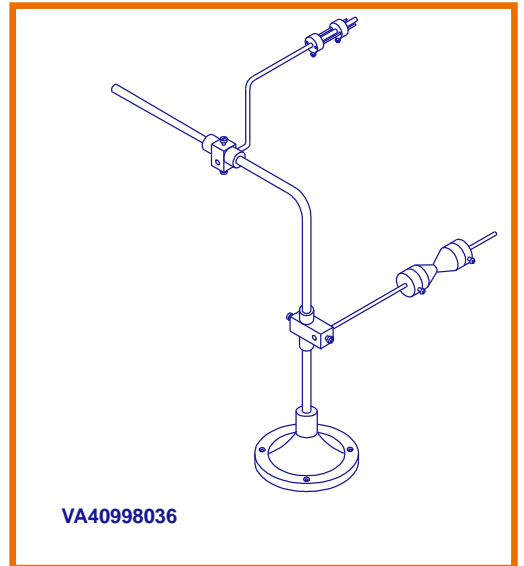
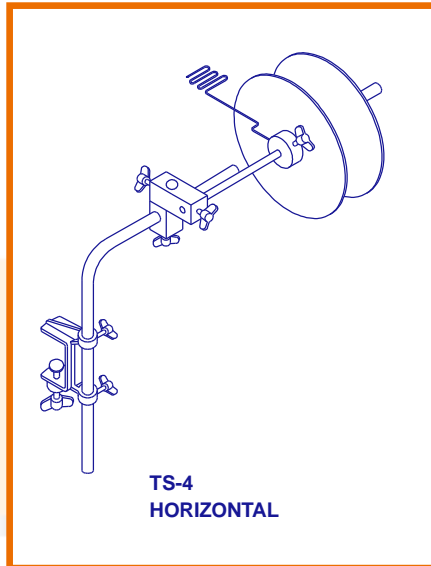
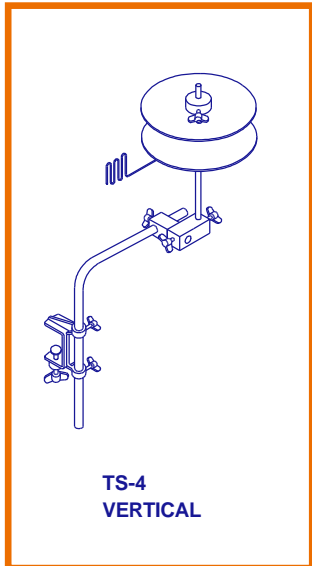



VA170012

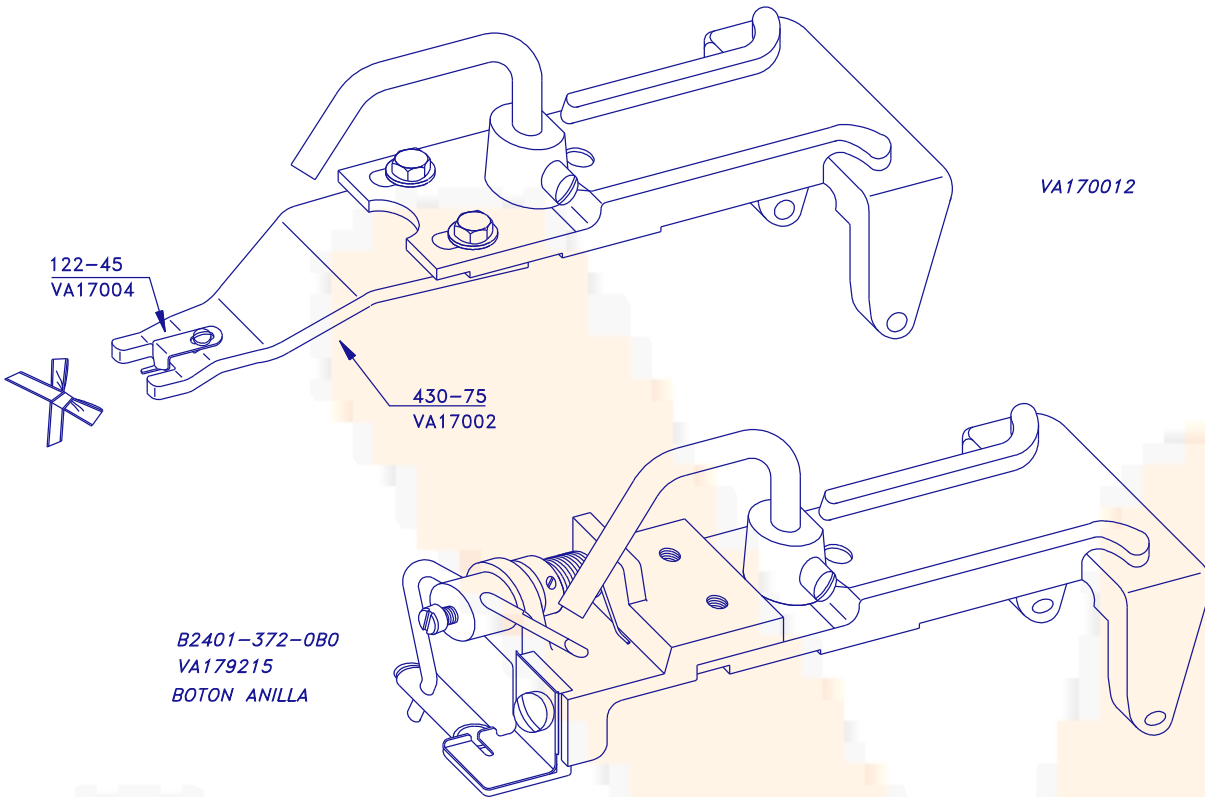

S07877-0-01
VA150122
BOTON ANILLA BROTHER

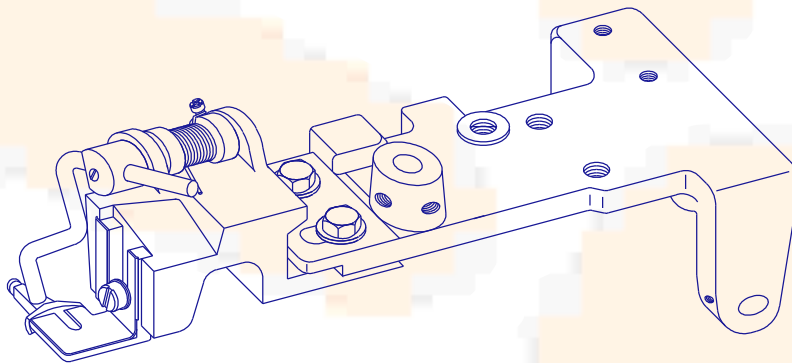

430-63-6
VA179216
BOTON PLANO

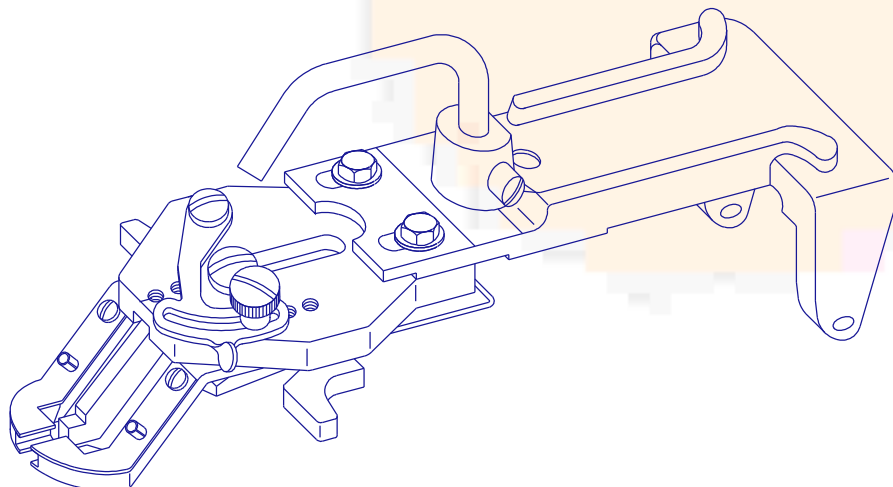

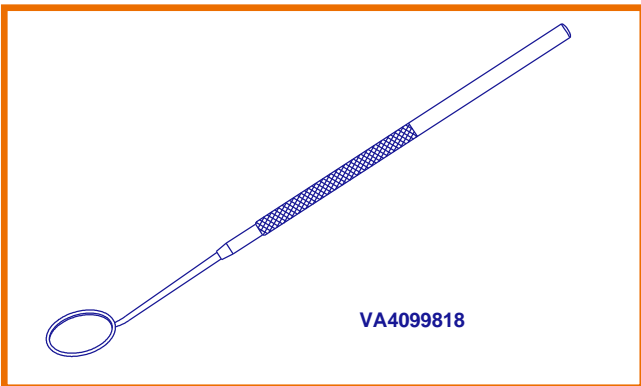

VA4099818

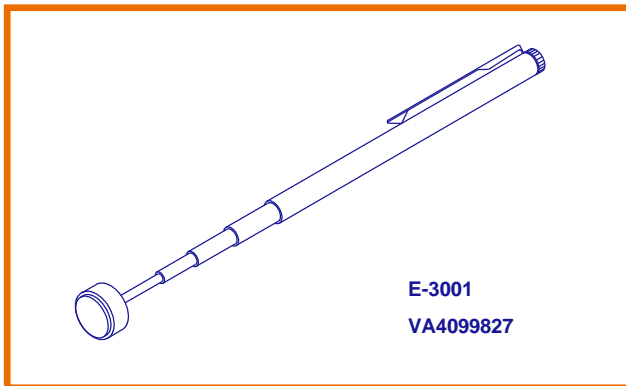

E-3001

VA4099827

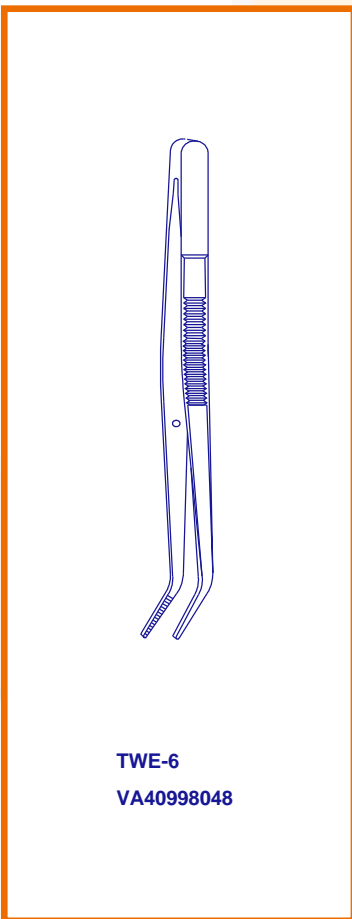

TWE-6

VA40998048

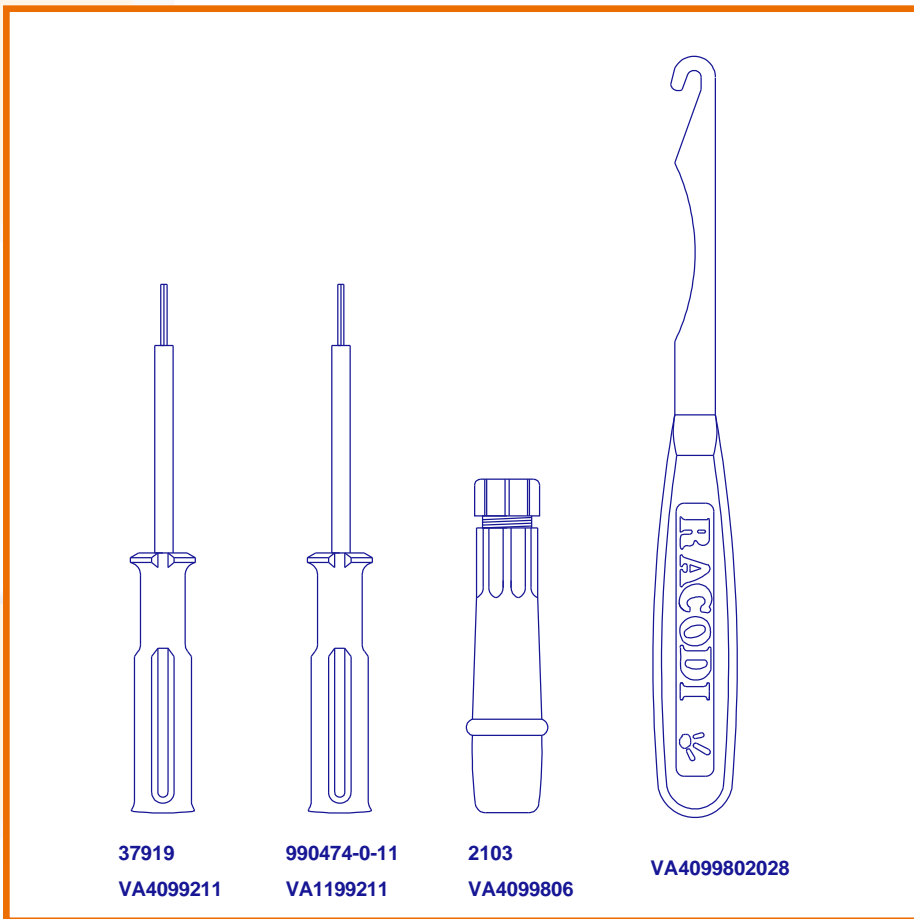

37919

VA4099211

990474-0-11

VA1199211

2103

VA4099806

VA4099802028

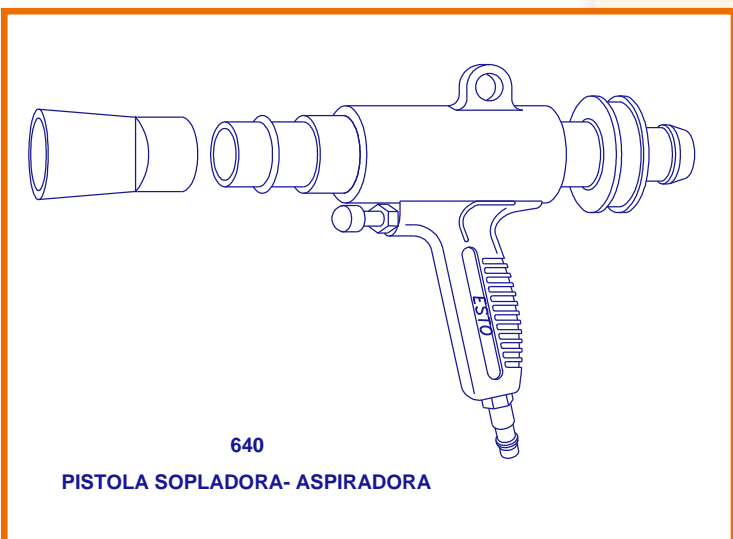

640

PISTOLA SOPLADORA- ASPIRADORA



SOPORTE CREMALLERAS

VA4099817



PALANCA MOTOR EFKA

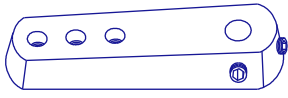

VA110045
 1200638
 VA110046
 1200001
 VA110047
 1200196



Interruptor
 VA409990

PROTECTOR OJOS

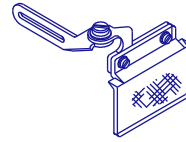

VA1202813

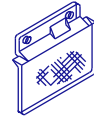

KC-19F
 VA1202801



259431
 VA4099811

LUPAS



SM-049



SM-048



SM-020

T-6-100



PRENSAS

T-6-190





VALVULA PEDAL



VA409982 ABRE AL SOLTAR
VA409981 ABRE AL PISAR



VA409983 DOBLE

VA409980



ACCESORIO ACCIONADO POR PEDAL QUE INCORPORA UN DETECTOR PARA COMANDAR COMPONENTES NEUMATICOS

ALFOMBRA



VA4099219

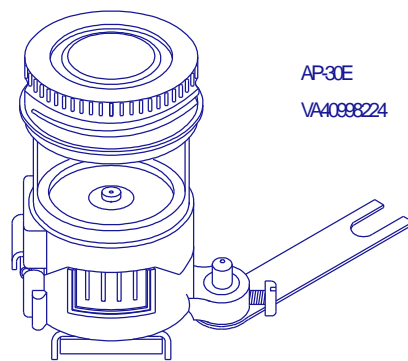

AP30E
VA40998224

LUZ FRIA



MR26

Se coloca en el plato de la máquina, delante del placa agujas, para poder ver la costura al trasluz





CUERDAS Y CINTAS ABRASIVAS



Flexibles para desbarbar, esmerilar y pulimentar zonas difíciles de alcanzar

Cuerdas y cintas abrasivas

Modelo	Longitud	Anch.	Velocidad	Grado	Superficie	Material
001	1000	100	1000	100	100	100
002	1000	100	1000	100	100	100
003	1000	100	1000	100	100	100
004	1000	100	1000	100	100	100
005	1000	100	1000	100	100	100
006	1000	100	1000	100	100	100
007	1000	100	1000	100	100	100
008	1000	100	1000	100	100	100
009	1000	100	1000	100	100	100
010	1000	100	1000	100	100	100
011	1000	100	1000	100	100	100
012	1000	100	1000	100	100	100
013	1000	100	1000	100	100	100
014	1000	100	1000	100	100	100
015	1000	100	1000	100	100	100
016	1000	100	1000	100	100	100
017	1000	100	1000	100	100	100
018	1000	100	1000	100	100	100
019	1000	100	1000	100	100	100
020	1000	100	1000	100	100	100

Las especificaciones técnicas de los productos pueden variar sin previo aviso. Reservados todos los derechos. No se permite la explotación económica ni la transformación de esta obra. Queda permitida la impresión en su totalidad.

TIJERAS



S105 VA7099806

CINTAS DE MEDIR



LR	GB	ES
32	30M	30M
N22	30M	30M
42	40M	40M

LAMPARA ARTICULADA



- OPCIÓN LED'S
- ARTICULACIONES POR ROTULA DE AMPLIO GIRO.
- ENCENDIDO SIN CEBADORES.
- FLUORESCENTE DE 11 w DE DOBLE TUBO.
- ALTO RENDIMIENTO LUMINICO.

VA409988

ALIMENTADORES TIRA



TFU-15-3..... 70 mm



TFS-25-3..... 70 mm

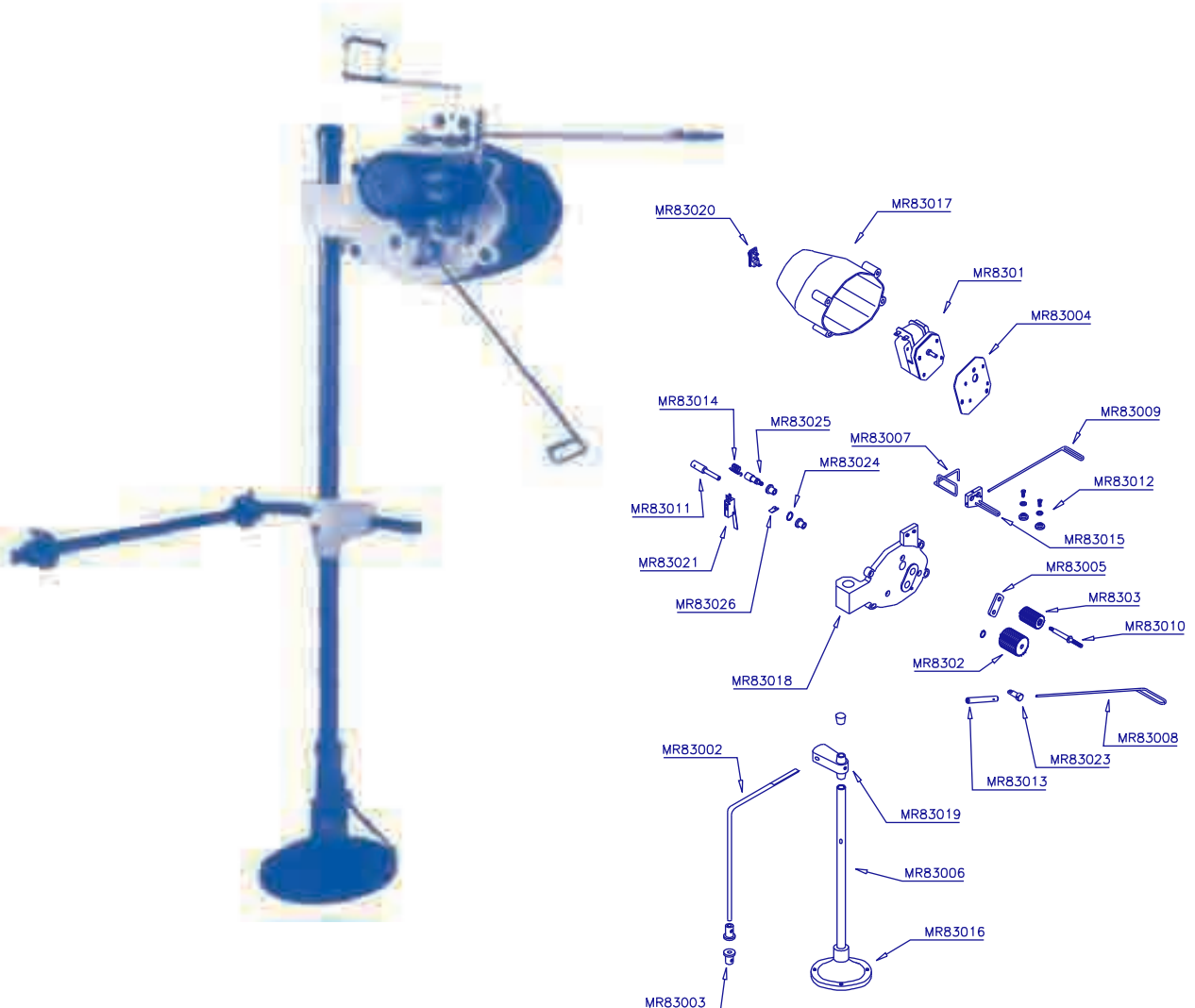



MAQUINAS DE AFILAR TIJERAS



MR-94

UNA SOLUCIÓN SENCILLA Y ECONÓMICA

La máquina MR 94 sirve para el afilado y pulido de cualquier tipo de tijeras, tanto de uso doméstico como profesional. Gracias a su brazo móvil, que permite deslizar fácilmente las tijeras, se consigue un acabado perfecto.



AX1210

Máquina de afilar tijeras

MAQUINA DE AFILAR CUCHILLAS



MR-811
MR-812

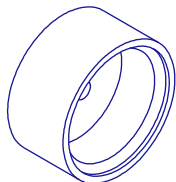

MUELA DIAMANTE
MR81101

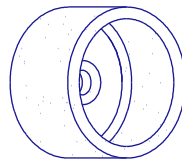

99000950-10
VA119989

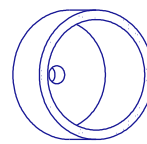

MUELA DE VASO
MR81103

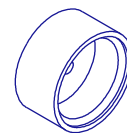

MUELA DIAMANTE
VA40988013

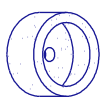

MCD20N
VA40988213

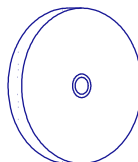

MUELA PLANA
MR81102

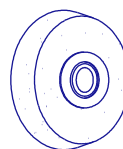

RFN05098
VA1199802



BRU ÑDORA
MR81104

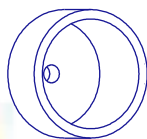

AX1010
MUELA DE VASO
100x10x20

AX1110

Máquina de afilar cuchilla con mola de vaso y mola de esmerilar



AX1310

Máquina de afilar cuchillas-tijeras

SOPORTES PARA AFILAR CUCHILLAS DE LAS MAQUINAS AX1110 Y AX1310

- AX2010-RIMOLDI27
- AX2012-RIMOLDI29
- AX2210-SIRUBAKR-35
- AX2212-SIRUBAKR-23
- AX2310-BROTHER SO20582
- MAUSSER 210755
- AX2312-BROTHER 144074-0-01
- AX2316-BROTHER SO20987
- BROTHER 144074 / 140
- AX2410-YAMATO 1
- AX2412-YAMATO 2
- AX2822-JUKI 118-45708
- AX2824-JUKI 118-45807
- AX2826-JUKI 118-45609
- AX2820-JUKI 118-45906



PIEDRAS DE PULIR

TAMAÑO	GRANO	REFERENCIA
6x13x150	100	5004
6x13x150	150	5104
6x13x150	220	5204
6x13x150	320	5304
6x13x150	400	5404
6x13x150	500	5504
6x13x150	600	5604



TAMAÑO	GRANO	REFERENCIA
10x10x150	100	5008
10x10x150	150	5108
10x10x150	220	5208
10x10x150	320	5308
10x10x150	400	5408
10x10x150	500	5508
10x10x150	600	5608

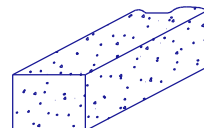

TAMAÑO	GRANO	REFERENCIA
2x6x150	220	5215
2x6x150	320	5315
2x6x150	400	5415
2x6x150	500	5515
2x6x150	600	5615

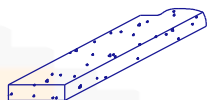

TAMAÑO	GRANO	REFERENCIA
6x25x150	100	5012
6x25x150	150	5112
6x25x150	220	5212
6x25x150	320	5312



COLGADORES

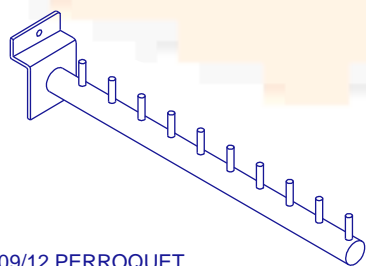

09/12 PERROQUET

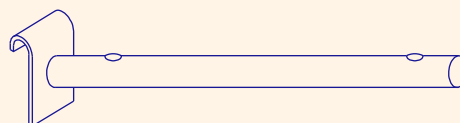

0670-SOPORTE ESTANTE



0210- BARRA CONFECCION

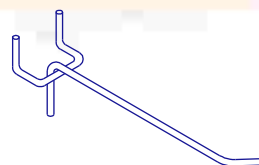

1070-GANCHO BLISTER

GUIA DE BORAS PARA BAÑO

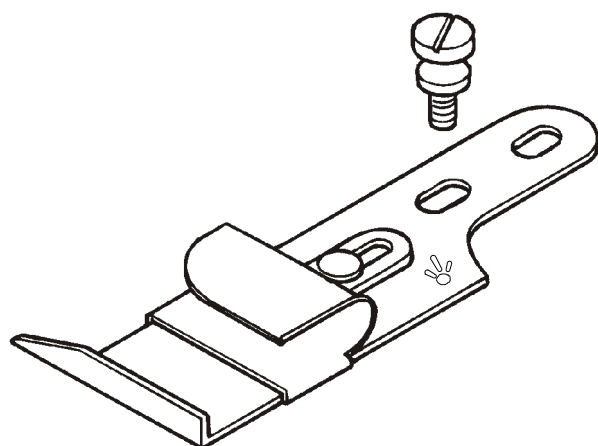

AJUSTABLE DE:

10 mm hasta 20

REFERENCIA

G-G0209 ----> 310030

G-300920-0 ----> 300920-0-10

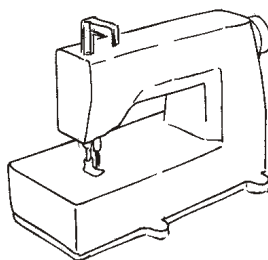
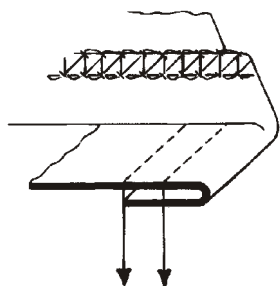

GUIA DE TIRAS DE SOBREPLATO

GUIA DE TIRAS DE SOBREPLATO

S124

S124B

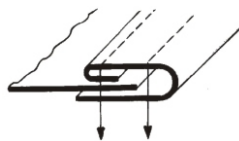

- B12-3/25x9
- B12-3/30x11
- B12-3/35x14
- B12-3/40x16
- B12-3/45x19
- B12-3/50x21
- B12-3/55x24
- B12-3/60x26
- B12-3/65x29
- B12-3/70x31
- B12-3/75x34
- B12-3/80x36
- B12-3/85x38
- B12-3/90x40
- B12-3/100x45

- B12-4/25x7
- B12-4/30x9
- B12-4/35x10
- B12-4/40x12
- B12-4/45x14
- B12-4/50x17
- B12-4/55x20
- B12-4/60x23
- B12-4/65x25
- B12-4/70x27
- B12-4/75x29
- B12-4/80x32
- B12-4/85x34
- B12-4/90x36
- B12-4/100x40

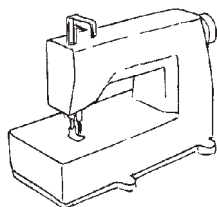
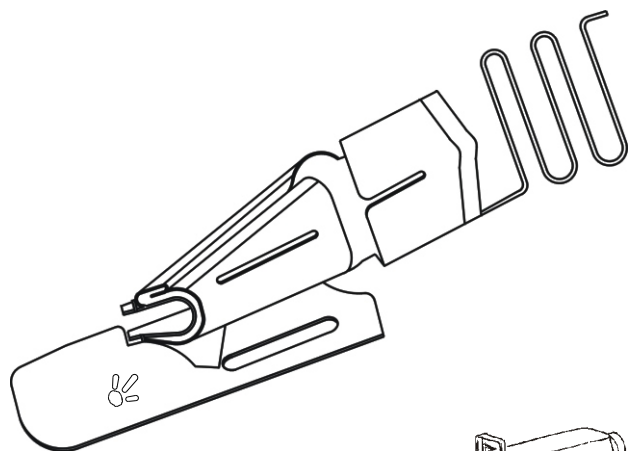

GUIA DE TIRA EMPOTRADA

GUIA DE TIRA EMPOTRADA

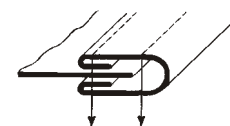
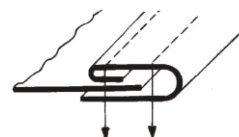

- B12-3E/25x9
- B12-3E/30x11
- B12-3E/35x14
- B12-3E/40x16
- B12-3E/45x19
- B12-3E/50x21
- B12-3E/55x24
- B12-3E/60x26
- B12-3E/65x29
- B12-3E/70x31
- B12-3E/75x34
- B12-3E/80x36
- B12-3E/85x38
- B12-3E/90x40
- B12-3E/100x45

- B12-4E/25x7
- B12-4E/30x9
- B12-4E/35x10
- B12-4E/40x12
- B12-4E/45x14
- B12-4E/50x17
- B12-4E/55x20
- B12-4E/60x23
- B12-4E/65x25
- B12-4E/70x27
- B12-4E/75x29
- B12-4E/80x32
- B12-4E/85x34
- B12-4E/90x36
- B12-4E/100x40

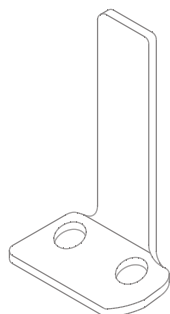
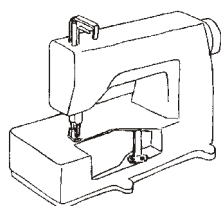
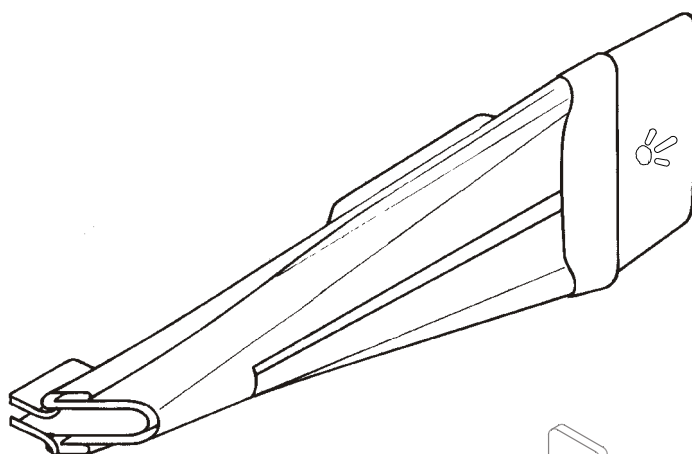

GUIA DE TIRAS DE SOBREPLATO

GUIA DE TIRAS DE SOBREPLATO

S124

S124B

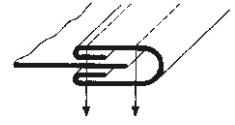
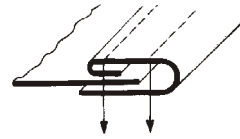
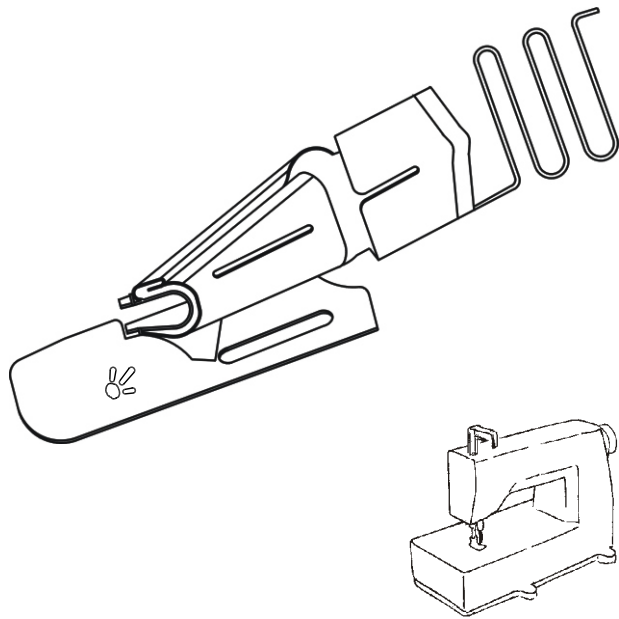

- B12-3/25x9
- B12-3/30x11
- B12-3/35x14
- B12-3/40x16
- B12-3/45x19
- B12-3/50x21
- B12-3/55x24
- B12-3/60x26
- B12-3/65x29
- B12-3/70x31
- B12-3/75x34
- B12-3/80x36
- B12-3/85x38
- B12-3/90x40
- B12-3/100x45

- B12-4/25x7
- B12-4/30x9
- B12-4/35x10
- B12-4/40x12
- B12-4/45x14
- B12-4/50x17
- B12-4/55x20
- B12-4/60x23
- B12-4/65x25
- B12-4/70x27
- B12-4/75x29
- B12-4/80x32
- B12-4/85x34
- B12-4/90x36
- B12-4/100x40

GUIA DE TIRA EMPOTRADA

GUIA DE TIRA EMPOTRADA

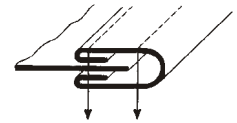
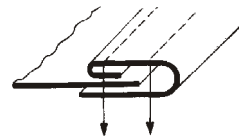
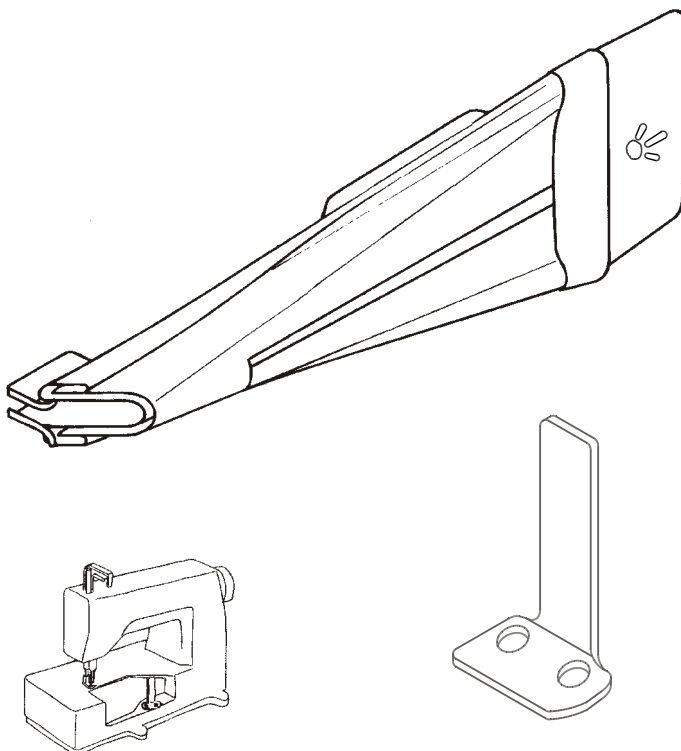

- B12-3E/25x9
- B12-3E/30x11
- B12-3E/35x14
- B12-3E/40x16
- B12-3E/45x19
- B12-3E/50x21
- B12-3E/55x24
- B12-3E/60x26
- B12-3E/65x29
- B12-3E/70x31
- B12-3E/75x34
- B12-3E/80x36
- B12-3E/85x38
- B12-3E/90x40
- B12-3E/100x45

- B12-4E/25x7
- B12-4E/30x9
- B12-4E/35x10
- B12-4E/40x12
- B12-4E/45x14
- B12-4E/50x17
- B12-4E/55x20
- B12-4E/60x23
- B12-4E/65x25
- B12-4E/70x27
- B12-4E/75x29
- B12-4E/80x32
- B12-4E/85x34
- B12-4E/90x36
- B12-4E/100x40

GUIA DE VIVOS DE OWERLOCK

GUIA DE VIVOS DE OWERLOCK

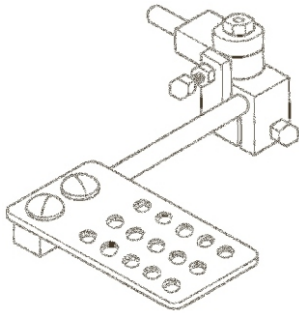

REFERENCIA

B65-14
B65-16
B65-19
B65-20
B65-22
B65-25
B65-30
B65-35
B65-40
B65-45

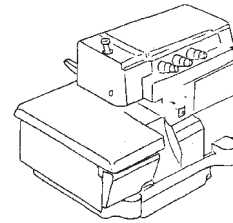
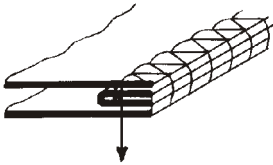
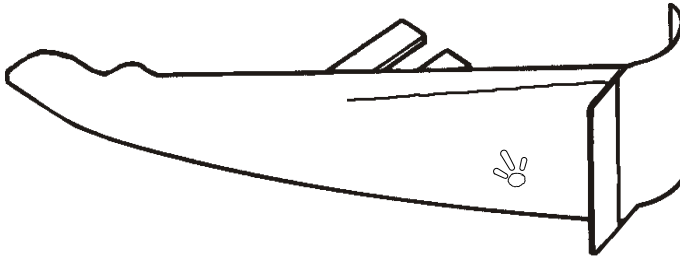

GUIA DE VIVOS DE OWERLOCK CON OREJA

GUIA DE VIVOS DE OWERLOCK CON OREJA

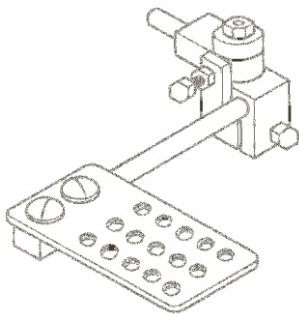

REFERENCIA

B65-E-14
B65-E-16
B65-E-19
B65-E-20
B65-E-22
B65-E-25
B65-E-30
B65-E-35
B65-E-40
B65-E-45

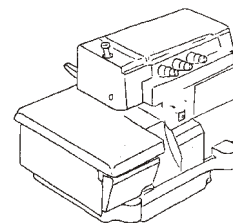
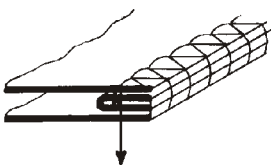
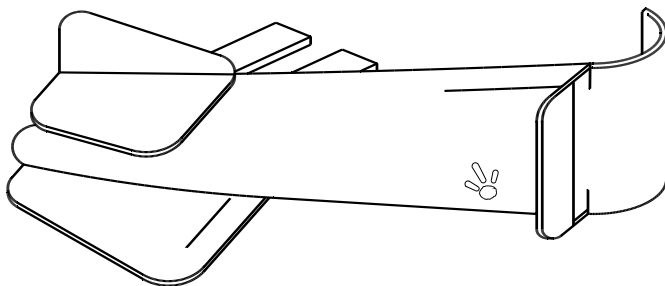

GUIA PARA BANDAS

GUIA PARA BANDAS

REFERENCIA

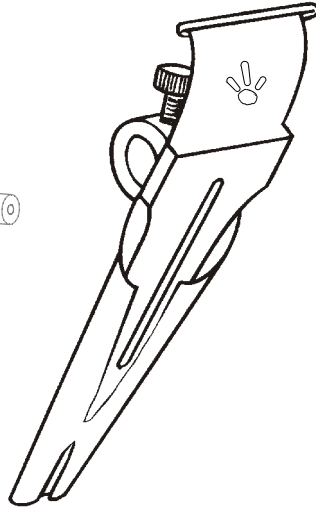
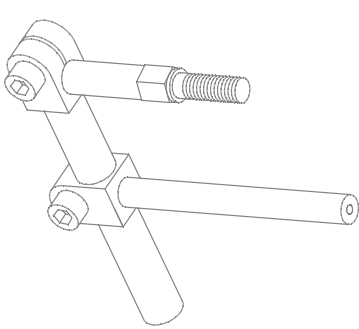

B68/12x6	B68/38x19
B68/14x7	B68/40x22
B68/16x8	B68/44x26
B68/18x9	B68/47x29
B68/20x10	B68/48x31
B68/22x11	B68/50x32
B68/24x12	B68/51x34
B68/26x13	B68/54x36
B68/28x14	B68/58x41
B68/30x15	B68/60x42
B68/32x16	B68/73x55
B68/35x17	

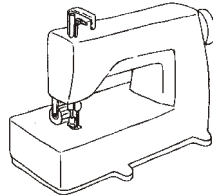
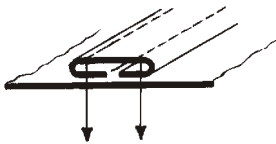

GUIA DE VIVOS AEREA

GUIA DE VIVOS AEREA

REFERENCIA

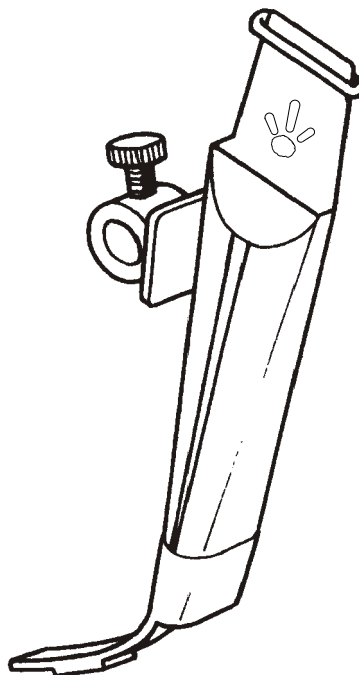
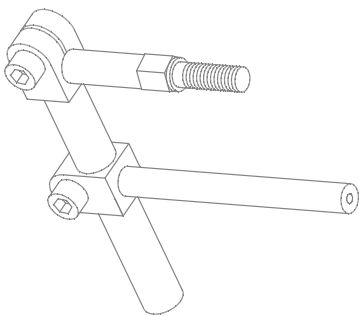

B67-15
B67-20
B67-25
B67-30

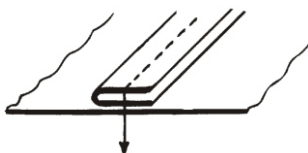

TALLERES MECÁNICOS
MARCAN



Carrasco i Formiguera, nº64-66
Pol. Ind. Pla d'en Boet
Codigo Postal 08302 MATARÓ
Barcelona - Spain

TALLERES MECÁNICOS
MARCAN

Telf. +34 937 552 037 • Fax +34 937 552 028
<http://www.racodi.com> <http://www.racodimarcán.com>
E-mail: ventas@racodi.com taller@racodi.com